

March 2020



CONTENTS

Alphabetical Product Directory

Chance Guest	17
Chance Stool	22
Chirp Guest	25
Chirp Lounge	28
Chirp Stools	32
Cielo Benches	35
Cielo Lounge	37
Cielo Tables	41
Clipse	44
Crest	49
Dabble	52
Editor	62
Faction Executive/Task	67
Faction Guest/Nesting	73
Faction Swivel	80
Fling Guest	84
Fling Lounge	87
Flurry Guest	90
Flurry Stool	92
GoGo	94
Gradient	100
Hado Benches	103
Hado Guest	107
Hado Lounge	110
Hado Meeting Tables	114
Hado Occasional Tables	116
Kamio	119
Kenzie	121
Lucent Guest	123
Melina Conference/Executive	125
Melina Guest	127
Melina Lounge	129
Melina Meeting Tables	133
Melina Occasional Tables	136
Memento Executive	138
Memento Task	145
Mozie Guest/Tandem	152
Mozie Occasional Tables	159
Nexxt Guest	161
Nexxt Nesting	165

Alphabetical Product Directory

Nexxt Task	169
Notion	176
Olé Guest	187
Particles Modular	192
Particles Jr.	205
Particles Tables	210
Pixie	213
Playground	215
Playground Occasional Tables	230
Popover	232
Propel	235
Recess	240
Signal	243
Simplex	247
Skyline Meeting Tables	250
Skyline Occasional Tables	253
String Games	256
Suite Benches	264
Suite Guest/Tandem	266
Suite Lounge	288
Twirl Guest	293
Twirl Lounge	298
Visor Lounge	307
Visor Modular	314
Wake	327
Whim Beam	331
Whim Guest	344
Whim Task	350

General Information

Terms and Conditions	4
Shipping Information	6
Quick-Ship Program	7
Sustainability	8
Fabric Information	9
Finish Information	11
Warranty	12
Mechanism Guide	13
Options	16

PRODUCT CATEGORY AND REFERENCE

Executive, Conference and Task Seating



Editor
page 62



Faction Exec./Task
page 67



Faction Swivel
page 80



Gradient
page 100



Kamio
page 119



Melina
page 125



Memento Executive
page 138



Memento Task
page 145



Nexxt
page 169



Notion
page 176



Propel
page 235



Simplex
page 247



Whim
page 350

Guest, Tandem and Beam Seating



Chance
page 17



Chirp
page 25



Faction
page 73



Fling
page 84



Flurry
page 90



Hado
page 107



Lucent
page 123



Melina
page 127



Mozie
page 152



Nexxt
page 161



Nexxt Nesting
page 165



Olé
page 187



Recess
page 240



Signal
page 243



Suite
page 266



Twirl
page 293

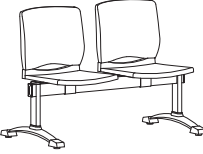

Whim Beam
page 331



Whim Guest
page 344

PRODUCT CATEGORY AND REFERENCE

Lounge and Modular Seating



Chirp
page 28



Cielo
page 37

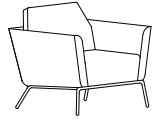

Clipse
page 44



Crest
page 49

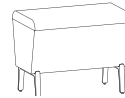

Dabble
page 52



Fling
page 87

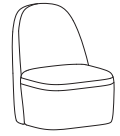

GoGo
page 94

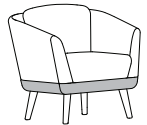

Hado
page 1



Melina
page 129

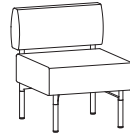

Playground
page 215



Suite
page 288



Twirl
page 298

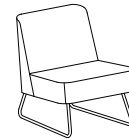

Visor
page 307

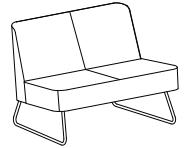

Visor Modular
page 314

Bench Seating and Stools



Chance Stool
page 22



Chirp Stool
page 32

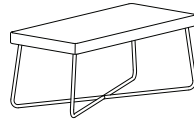

Cielo Bench
page 35



Flurry Stool
page 92



GoGo
page 94



Hado
page 103

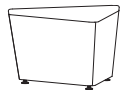

Particles
page 192

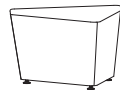

Particles Jr.
page 205



Pixie Stool
page 213



Popover
page 232



Suite Bench
page 264



Wake Stool
page 327

Tables



Cielo
page 41



Hado
page 114



Kenzie
page 121



Melina
page 133

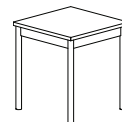

Mozie
page 159



Particles
page 210



Playground
page 230



Skyline
page 250

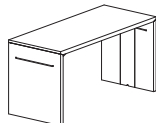

String Games
page 256

Introduction

Raising the benchmark in design, comfort and flexibility, Encore is a leading provider of contemporary, options-oriented seating and table products for a host of applications, ranging from corporate offices to educational institutions, hospitality, healthcare facilities and more.

With a focus on flexibility and personalized attention, we strive to provide innovative solutions for ever-changing requirements and deliver outstanding service for our customers every time, offering standard lead-times of 6 weeks, an extensive Quick-Ship program, as well as partnerships with some of the most widely recognized textile manufacturers in the industry.

Sharing strong organizational ties to our parent company, Arcadia, we are able to draw upon an established knowledge base of product design, engineering, sales and service, all the while maintaining competitive pricing and a comprehensive warranty on all products.

This price list contains all relevant instructions, conditions of sale and shipping information to facilitate the ordering process. Additionally, our client services staff and Sales Representatives are available to assist with any questions you may have.

Prices

The prices indicated in this price list are for standard Encore products. This price list supersedes any previous price lists or supplemental price lists. We reserve the right to modify prices without prior notification.

Terms

Net 30 days to credit approved accounts. The customer will be liable for any costs incurred in attempting collection of past due amounts, including collection and/or attorney fees. Past due accounts are subject to a 1% late charge for each month after 30 days.

Credit

A line of credit may be established upon acceptance of satisfactory references, including the completion and signing of our Credit Application Form. All new customers are required to remit 50% of the invoice amount with the placement of the purchase order, with the remaining balance due prior to merchandise release for shipment.

Order Acknowledgement

Order acknowledgement will be made for each order and indicates final production specifications. Customers should review the acknowledgement, notwithstanding any variance in terms and conditions set forth on the customer's order form.

Orders will not be acknowledged or entered for production until all specification information is complete. Upon final acceptance of the order by the factory, orders will be scheduled for production. For orders specified with COM, scheduling will occur upon receipt of customer's COM. Production begins when fabrics are received.

Ordering Procedures

To avoid unnecessary order entry delays, please be sure each order specifies the following information:

1. Quantity
2. Model number
3. Item description
4. Size (as applicable)
5. Finish (wood and/or metal finish)
6. Fabric (including any special instructions)
7. Options (list with each specific product)
8. Drawing for modular seating configurations
9. Shipping destination, contact name and phone number
10. Purchase order number
11. Special instructions, if any

Purchase orders placed by telephone will be accepted, but will not be scheduled for production until a written, signed confirmation of order is received. Faxes or emails to orders@encoreseating.com of purchase orders will be accepted. **Fax: 714.562.8202**

Order Changes and Cancellations

Encore must approve all order changes. Additions or changes to acknowledged orders may be subject to rescheduling of order. Cancellations, partial or otherwise, may be subject to cancellation charges or restocking fees. Contact client services for applicable charges.

Claims

For your protection it is imperative that you read this notice.

The merchandise you receive has been inspected at our factory to ensure that it is of the highest quality and in perfect condition prior to being shipped.

Reference this page and check the following upon receipt of merchandise.

1. Any items/cartons missing? Be sure that you have received the same number of cartons as appears on the delivery receipt. Make note of the cartons missing on the delivery receipt before you sign it.
2. Any items damaged? No matter how slight, all damage to items/cartons should be noted on delivery receipt before you sign. Do not sign or accept merchandise until you have checked all cartons thoroughly. Do not refuse shipments that may be or appear to be damaged.
3. Immediately after delivery, all cartons should be opened and all merchandise inspected for damage. Items may be damaged in transit, even though outer cartons do not show damage.
4. If any damage is found, contact Encore client services in writing immediately. Please include photos whenever possible, as well as the order information on the printed ticket under the chair seat and/or table-top.
5. All cartons must be saved until the freight carrier has made an inspection.
6. If incorrect merchandise is received, please contact client services.

Returns

Encore must pre-approve and issue a Return Authorization prior to any product being returned to the factory. Any unauthorized returns, should they appear at our factory, are automatically refused and they become the responsibility of the shipper and the carrier involved. Please contact client services before returning any merchandise.

In order to resolve the problem at hand as rapidly as possible, please include all information pertinent to the problem. The most pertinent information required is:

1. Reason for return
2. Invoice number and/or sales order number
3. Product code numbers for affected product(S)

Upon receipt of your request, we will issue proper return authorization or furnish you with instructions in order to settle this matter to your complete satisfaction.

Product Design

We reserve the right to alter or discontinue certain product designs and/or materials without notice to facilitate improvements in design, construction and functionality.

Shipping Information

Products shipped via the Encore freight program are for normal delivery only and do not include expedited shipping, inside delivery, lift gates, installation, unpacking or the removal of cartoning materials. Any request for carrier “pre-delivery” notification should be noted on the original purchase order. Encore reserves the right to ship via the most appropriate carrier and/or routing on all shipments. If the customer specifies a carrier, other than a pre-approved carrier, freight will ship collect or 3rd party bill at the customer’s expense via the designated carrier. Any additional costs related to post shipment issues such as reconsignment charges, storage charges, etc., will be the responsibility of the customer.

Freight Program

All products are shipped F.O.B. La Palma or Cerritos, CA, freight prepaid and allowed.

The freight program guarantees the product will be delivered freight prepaid to the designated consignee based on a minimum shipment value of \$2,500 NET. If the value of the shipment does not meet the minimum requirement, a freight surcharge per shipment will be assessed based on the destination territory as listed below.

Please contact client services for minimum shipment values and corresponding surcharges on Canadian shipments. Shipments outside the contiguous U.S. and Canada are shipped to the point of embarkation free of charge as long as the shipment meets the minimum requirement; otherwise, the freight surcharge applies. All subsequent freight charges beyond the point of embarkation will be at the customer’s expense, shipped collect.

Customers in CA, AZ and Las Vegas, NV shipping outside Territory 1 must contact Client Services for applicable charges.

This freight program does not apply to “Will Call” orders.

For shipment of textiles or component parts, actual freight charges will apply and be added to the invoice.

Due to the fluctuations of fuel prices, Encore reserves the right to impose fuel surcharges to invoices for any shipments.

Destination	Freight Surcharge
Territory 1	\$65 NET
Territory 2	\$135 NET
Territory 3	\$150 NET

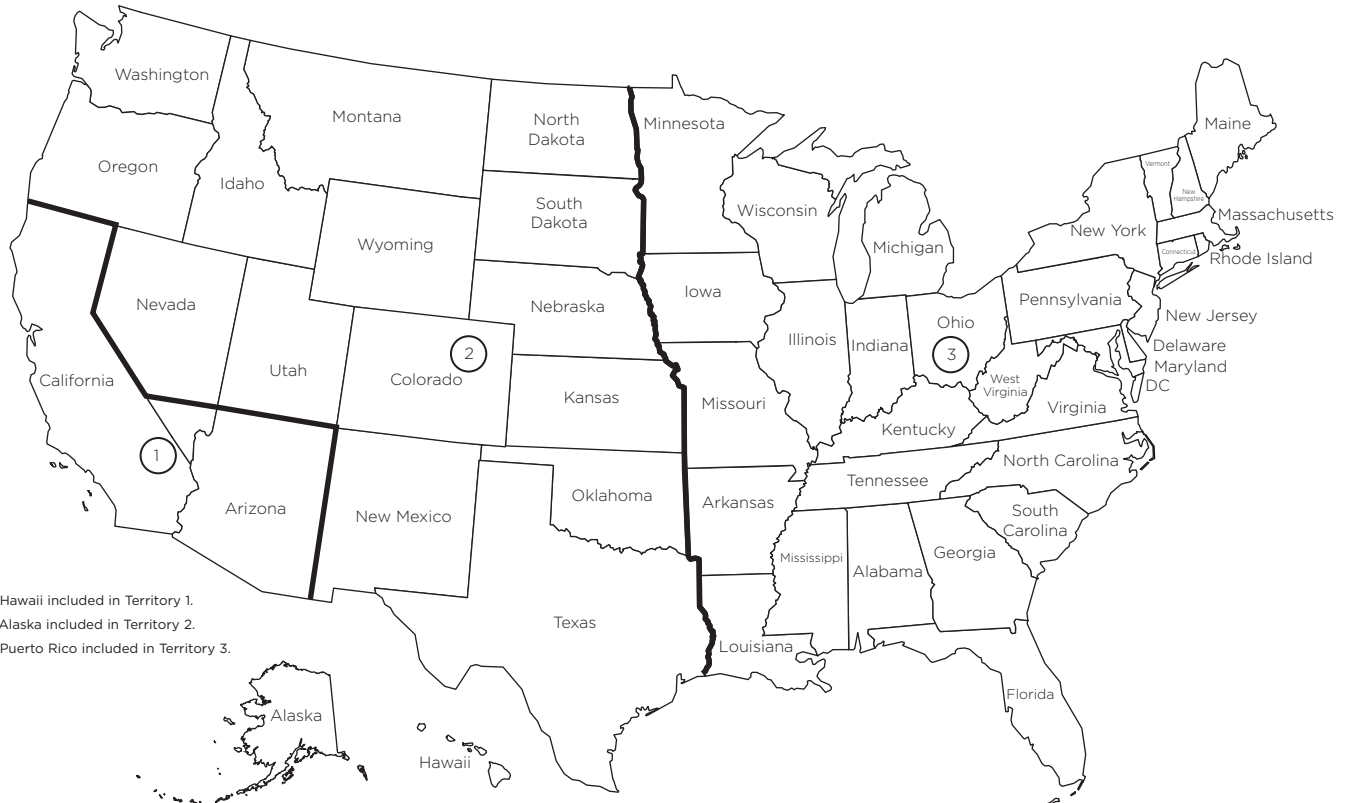

*Hawaii included in Territory 1.
 *Alaska included in Territory 2.
 *Puerto Rico included in Territory 3.



QuickTime Program

For the ultimate time saving solution, Encore offers the **QuickTime** program. Featuring a wide variety of upholstery selections, poly colors, wood and metal finishes, the QuickTime program allows product to be ordered today, for a guaranteed ready-to-ship status within 10-15 business days. For available models, just look for the QuickTime icon throughout this price list.

QuickTime Terms & Conditions:

- Lounge seating and tables: maximum purchase order quantity of 10 units (in any combination).
- All other models: maximum purchase order quantity of 25 units (in any combination).
- QuickTime purchase orders must be designated as such and placed separately from standard lead-time purchase orders - no split purchase orders allowed.
- Lounge seating and tables will be complete and ready to ship within fifteen business days upon acceptance of purchase order.
- All other models will be complete and ready to ship within ten business days upon acceptance of purchase order.
- COM/COV acceptable - manufacturing time begins subsequent to receipt of COM fabric or vinyl.
- Encore reserves the right to choose method of shipment.
- For complete terms and conditions, including fabric limitations, please refer to the QuickTime brochure.

Sustainability/SCS Certification

As a matter of corporate philosophy, Encore is committed to intelligent environmental policies and practices. Standard recycling procedures and ecologically sensible policies and practices have been implemented throughout all aspects of our operations/facilities, and as it relates to new product development and project management. Additionally, we insist on a similar operational philosophy from our vendor-partners.



In accordance with our ongoing efforts to develop and manufacture products that positively contribute to healthy environments, Encore has completed testing for Indoor Air Quality certification, achieving SCS Indoor Advantage Gold for the majority of seating and table products.

By attaining SCS Indoor Advantage Gold certification, we not only meet the criteria of BIFMA M-7.1 and X-7.1 (low-emitting office furniture systems and seating) but also the LEED-Commercial Interiors EQ 4.5 credit for Indoor Air Quality of office furniture.

We will continue to strive towards developing products that positively contribute to healthy environments, as well as set new benchmarks for making sustainable improvements in all areas of our business. A representative example of other in-force measures Encore employs to support intelligent environmental policies include:

- Ensure product life-cycle longevity and non-obsolescence via the design, engineering, and manufacturing processes and subsequent product refurbishment and re-use potential.
- Design products, and/or re-engineer existing to maximize the use and or re-use of recycled and/or recyclable components and sub-parts.
- Specify, and utilize 'engineered pre-cut' foam, which eliminates virtually all on-site scrap foam waste.
- Increase the use of recyclable materials as appropriate for all general office, marketing, manufacturing, and shipping applications.
- Eliminate use of any non-recyclable packaging materials.
- Utilize alternative shipping methods such as 'blanket-wrapped delivery' whenever possible as well as consolidate freight to reduce overall fossil fuel consumption and carbon emissions.
- Minimize the generation of, recycle, and/or ensure the proper disposal of all office-generated waste materials.
- Contract for the external use of scrap leather cutting remnants.
- Participate in fabric tube and memo sample take-back programs.

We are committed to being a leader in the practical application of current and future technologies that will protect our environment today, and for future generations to come.

Customer's Own Material

COM should be shipped prepaid to:

Encore Seating, Inc.
Attn: COM Department
5593 Fresca Dr.
La Palma, CA 90623

All packages should be marked with customer's name, customer's order number and items to be covered. Collect shipments of COM/ COL fabrics will not be accepted. Please furnish a sample cutting of COM or COL with the original purchase order so that identification of COM/COL can be verified. In the absence of specific written instructions accompanying the order, fabrics will be cut, seamed and applied at our discretion and at the customer's risk. An additional fee may be assessed for COM or COM materials that are deemed atypical should additional labor be required to cut, sew and/or match said materials.

While we inspect fabrics for mill imperfections, some are difficult to recognize. As such, we cannot be responsible for defects, color inaccuracies, dye lot variations and other flaws and suggest that our customers inspect fabrics before furnishing them. Under no circumstances will we assume responsibility for COM/COL shortages, flaws or other such problems. While we make a concerted effort to control COM/COL fabrics, it is not our responsibility to police the receipt of COM/COL's in order to meet delivery deadlines and we assume that customers are aware of any undue delay in the delivery of their COM/COL fabrics.

Encore cannot be responsible for defects, color inaccuracies, dye or lot variations and other flaws and suggests our customers inspect fabrics before furnishing them. Under no circumstances will we assume responsibility for COM shortages, flaws or other such problems.

Polyurethane

Polyurethane fabrics and other PVC-free materials may be susceptible to "puddling" or comfort wrinkles over time. This is due to the inherent properties of the fabric and not an indication of inferior upholstery techniques. Please keep this in mind when selecting fabrics for upholstery.

Fire Resistance

Encore manufactures all of its chairs to comply with California Technical Bulletin #117 (Cal TB 117). If Customer's Own Material (COM) is specified, Encore is not liable for said COM fabric's non-compliance with Cal TB 117.

California Technical Bulletin #133, the Flammability Test Procedure for Seating Furniture for Use in Public Occupancies, was repealed by the California legislature on January 22, 2019. If compliance to TB133 is required, add \$50 List per yard of fabric utilized by the seating product specified for the application of a fire barrier.

Fabric Application

COM fabric is cut "up the roll" as a standard cutting procedure (see chart below). Customer must specify that the fabric be cut in another direction (i.e. "railroaded") if required.

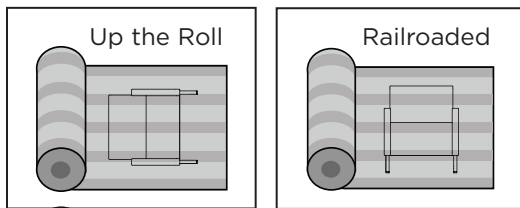

It is imperative that all COM fabrics sent to Encore be "backed" with, at minimum, an acrylic or similar backing. We cannot be responsible for stretching of fabrics that are not backed subsequent to upholstery process. Additionally, we cannot be held responsible for the appearance, behavior, quality or performance of any COM as well as COM's that are rolled reversed by the fabric supplier.

The application of patterned fabrics on curved seating units will be stitched to match pattern requirements. Geometric, linear and striped fabrics will be stitched together to provide the best match, however, a "V" pattern may be the result which is not considered to be a flaw. Additionally, due to varied stretch properties among fabrics, slight wrinkling or puddling may occur. Contact our Client Services Department for any concerns regarding upholstery selections.

Yardage Requirements

COM yardage requirements shown in this price list are based on using fabric which is plain (i.e. non-directional) and a full 54" wide. Fabrics of narrower widths and/or that involve matching repeats will require additional yardage. Use the chart below to determine the necessary additional yardage for both directional fabrics and narrow width fabrics.

If you are using a printed or striped fabric with a repeat, use this table:

Fabric Repeat	Increase COM Requirement by:
4.9" and under	0%
5" – 10.9"	12%
11" – 15.9"	18%
16" – 20.9"	25%
21" and over	40%

Yardage requirements may be less than indicated on large quantity orders. Contact client services with specific chair quantities for exact yardage required.

If you are using a plain fabric less than 54" wide or a pattern that will be applied railroaded, contact client services for assistance, as additional yardage may be required. If you are using a plain fabric less than 54" wide or a pattern that will be applied railroaded, contact client services for assistance, as additional yardage may be required.

Upholstery Combinations

For fabric, vinyl or leather upholstery combinations, pricing will be calculated as follows:

- When combining two COM/COV/COL fabrics, or fabrics with the same grade, add \$85 List per unit.
- When combining three or more COM/COV/COL fabrics, or fabrics with the same grade, add \$115 List per unit.
- When combining different grades of fabric, price will be based on the highest grade specified.

Additional Fabric Programs

Encore offers a selection of its own fabrics and leathers for upholstery. Refer to the presentation cards offered in our commercial catalog. Along with these fabrics, Encore, in conjunction with Architex, Camira, Designtex, Maharam, Mayer, Momentum and Stinson, develops additional fabric programs to allow our customers to simplify the ordering of products and fabrics at one time. Please refer to the Textile Partner Program brochure or contact client services for additional information.



Standard Laminate Tops

Plastic laminate tops are standard on all tables and rotating tablelets. We offer a range of standard wood grain, solid and patterned laminate options to suit a variety of applications. All standard colors follow below.

Wood Grain Laminates

Nevamar WM-8-340T Clear Maple
 Nevamar WM-0005T Siren Maple
 Pionite Wilsonart 7954-38 Natural Rift
 WM951-SD Honey Maple
 Wilsonart 7937-38 River Cherry
 Wilsonart 7039-78 Windsor Mahogany
 Wilsonart 7935K-07 Shaker Cherry

Wilsonart 7122-K-07 Empire Mahogany
 Formica 7739-58 Cocoa Maple
 Pionite WX421-PV Witchcraft
 Pionite WY160-SD Absolute Acajou
 Nevamar WM-0047T Iconic Maple
 Pionite SE101-AW Black Ashwood

Solid Color Laminates

Formica 459-58 Brite White
 Pionite SG228-SD Slate
 Wilsonart 1595-60 Black

For all table widths, wood grain laminates will run parallel to width of table.

Non-Standard Laminate Tops

In addition to our standard laminates, we also accept most laminates from the following manufacturers: Formica (standard grade, matte texture), Nevamar, Pionite (standard grade, suede texture) and Wilsonart. Mirror, high gloss and metal laminates are not available.

For non-standard laminates, add \$550 List per color per order. Pre-approval required, please contact client services.

Solid Surface Material

Solid surface is available on a variety of seating and table collections; please refer to corresponding price list pages for availability and pricing. In most instances (except where noted), solid surface tops are affixed to table surface increasing overall table height by 1/2". Solid surface available in white only.

To order a non-standard solid surface color, please specify the manufacturer, pattern name and color number. Contact client services to confirm pricing.

PVC Edge Colors

PVC edge may be specified in lieu of laminate self edge on select connecting and occasional tables. A limited number of color options are available which closely, but do not exactly, match the Encore solid laminate finishes. All standard colors are listed as follows and are available at no upcharge: Black, Slate Grey, White.

Back-Painted Glass

White back-painted glass is available on select tables and tablelets; please refer to corresponding price list pages for applicable pricing.

Wood Finishes

Encore standard wood finishes are listed as follows:

Ash	Beech	Maple	White Oak	Walnut
162 White Oak on Ash	12 Natural Beech	10 Natural Maple	14 Natural White Oak	29 Natural Walnut
163 Walnut on Ash	22 Caramel Beech	11 Natural Beech on Maple	18 Slate Grey Oak	30 Cinnamon Walnut
164 Cocoa Ash	27 Ebony Beech	21 Caramel Maple	19 Smoky Umber Oak	35 Bourbon Walnut
165 Kona Ash	33 Cinnamon Beech	26 Ebony Maple	20 Caramel Oak	
166 Smoky Umber Ash	38 Bourbon Beech	31 Cinnamon Maple	25 Ebony Oak	
167 Slate Grey Ash	43 Autumn Beech	36 Bourbon Maple	32 Cinnamon Oak	
	73 Kona Beech	41 Autumn Maple	37 Bourbon Oak	
	85 Cocoa Beech	71 Kona Maple	44 Autumn Oak	
		115 Cocoa Maple	70 Kona Oak	
			123 Cocoa Oak	

Please refer to the Encore finish card for digital representations or contact our Literature Fulfillment Department for samples.

For custom wood finishing, please add one-time upcharge of \$450 List per color, per order, for all products.

Wood Finish Maintenance

As with all fine finishes, care should be taken to protect the finish from sharp, unprotected objects. The top coat has a natural characteristic to repel the most common liquids used around wood components, yet spills or soil marks should be cleaned up immediately to avoid moisture seeping into open-pore areas. Please note that constant polishing and cleaning of the finish may raise the sheen level, whereas neglect in cleaning will dull and possibly abrade the finish.

Encore provides a lifetime warranty for all seating products to be free from defects in material and workmanship on structural frame components. All other materials fall under the applicable warranty periods listed in the table below. The company will repair or replace, at its option, without charge to the original purchaser only, defective products or parts that fail during normal use (normal use is defined as eight (8) hour days, five (5) days per week) throughout the applicable warranty period. Field labor and service(s) are not covered under this warranty.

Lifetime Warranty	Frame Components Adjustable Arms and Arm Pads Mechanisms Gas Cylinders
10 Year Warranty	Foam Exposed Wood Components Tables Tablets
4 Year Warranty	Casters Mesh and Knit Materials
2 Year Warranty	Stool Footrings
1 Year Warranty	Fabric/Vinyl (excluding COM, COV and COL) Electrical Units

COM, COV and COL are also not covered by this warranty. Normal wear and tear is the responsibility of the specifier. Please consult with upholstery material suppliers for performance criteria of individual materials.

Due to the inherent stretch properties of certain woven and/or vinyl upholstery materials, Encore cannot be held responsible for wrinkles or "puddling" that can occur in some materials.

If product fails under normal use within the warranty period, please send description of the pertinent part, together with proof of purchase of the product to:

Encore Seating, Inc.
Attn: Client Services
5692 Fresca Drive
La Palma, CA 90623

Email: clientservices@encoreseating.com
Fax: 714.562.8202

The foregoing warranty excludes any damages or defects caused by abuse of this product or its use for a purpose other than what the chair was intended. Encore Seating does not assume responsibility for unauthorized repairs to chairs that sustain damages resulting from user modification, improper assembly, attachments to product, misuse, alteration or negligent use of the product.

TO THE EXTENT ALLOWED BY LAW, ANY IMPLIED WARRANTY OF MERCHANTABILITY OR FITNESS FOR A PARTICULAR PURPOSE APPLICABLE TO THIS ENCORE SEATING PRODUCT IS LIMITED IN DURATION TO THE DURATION OF THE ABOVE EXPRESSED WRITTEN WARRANTY.

LIMITATION ON LIABILITY: IN NO EVENT SHALL ENCORE SEATING BE LIABLE TO THE PURCHASER FOR ANY INCIDENTAL, INDIRECT, CONSEQUENTIAL, SPECIAL, OR EXEMPLARY DAMAGES OR LOST PROFITS, EVEN IF ENCORE SEATING HAS BEEN ADVISED OF THE POSSIBILITY OF SUCH DAMAGES.

Some states do not allow the exclusion or limitation of incidental or consequential damages, hence the above restrictions or exclusions may not apply to you. This warranty gives you specific legal rights and you may also have other rights that vary from state to state.

Knee-Tilt

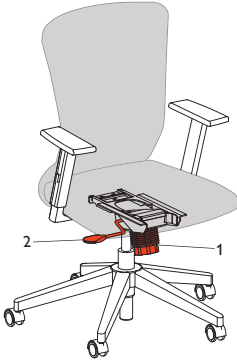

1. Tension Control Knob allows for greater spring tension control for a firmer or softer tilting motion. Turn counter-clockwise to increase tension, clockwise to decrease tension.
2. Seat Height/Tilt Lock Lever raises or lowers seat to desired height and locks seat into starting position in one convenient mechanism. To raise height, simply lift weight off seat and pull upward on lever until seat reaches a comfortable height. To lower height, lift upward on lever while seated and release to lock seat into desired position. To lock chair-tilt into starting position, push lever inward. To release tilt lock mechanism and free-float, simply pull lever outward.

Multi-Lever

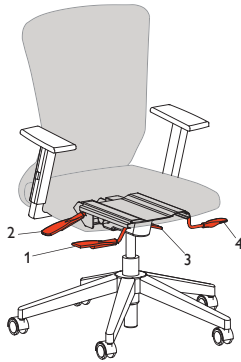

1. Seat Height Adjustment easily raises or lowers seat to desired height. To raise, lift weight off seat and pull upward on lever until seat reaches a comfortable height. To lower, lift upward on lever while seated and release to lock seat into desired position.
2. Seat Angle with Infinite Lock Lever allows for precise positioning of seat angle. Simply lift upward on lever until desired seat angle is reached. While the lever is in its uppermost position, adjustments can be freely made and then locked into place by pushing lever downward.
3. Back Angle with Infinite Lock Lever provides precise, independent back angle control. To adjust, lift upward on lever until desired back angle is achieved. To freely make adjustments without holding onto the lever, move lever into uppermost position, then, when a comfortable back angle is reached, push downward on lever to lock into place.
4. Optional Seat Slider adjustment provides 2½" front and back horizontal seat depth adjustment. To operate, lift up on adjustment bar and move seat forward or backward until desired depth is achieved. Release bar and seat will lock into position.

Swivel-Tilt with Tilt-Lock

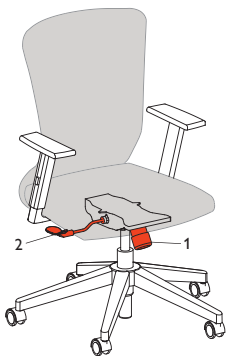

1. Tension Control Knob allows for greater spring tension control for a firmer or softer tilting motion. Turn counter-clockwise to increase tension, clockwise to decrease tension.
2. Seat Height/Tilt Lock Lever raises or lowers seat to desired height and locks seat into starting position in one convenient mechanism. To raise height, simply lift weight off seat and pull upward on lever until seat reaches a comfortable height. To lower height, lift upward on lever while seated and release to lock seat into desired position. To lock chair-tilt into starting position, push lever inward. To release tilt lock mechanism and free-float, simply pull lever outward.

Swivel-Tilt with Tilt-Lock and Seat Slider

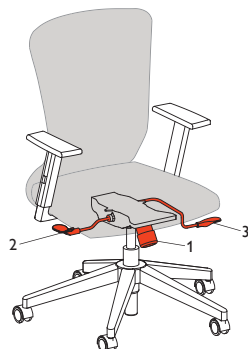

1. Tension Control Knob allows for greater spring tension control for a firmer or softer tilting motion. Turn counter-clockwise to increase tension, clockwise to decrease tension.
2. Seat Height/Tilt Lock Lever raises or lowers seat to desired height and locks seat into starting position in one convenient mechanism. To raise height, simply lift weight off seat and pull upward on lever until seat reaches a comfortable height. To lower height, lift upward on lever while seated and release to lock seat into desired position. To lock chair-tilt into starting position, push lever inward. To release tilt lock mechanism and free-float, simply pull lever outward.
3. Seat Slider adjustment provides 2½" front and back horizontal seat depth adjustment. To operate, lift up on adjustment bar and move seat forward or backward until desired depth is achieved. Release bar and seat will lock into position.

Synchro Knee-Tilt



1. Seat Height/Tension Control easily raises or lowers seat to desired height and allows for more precise spring tension adjustment. To raise, simply lift weight off seat and pull upward on handle until seat reaches a comfortable height. To lower, lift upward on handle while seated and release to lock seat into desired position. To adjust tension for a firmer or softer tilting motion, turn knob counterclockwise to increase tension, clockwise to decrease tension.
2. Multi-Position Tilt Lock Lever secures back into multiple tilt positions or allows it to free-float. To secure chair at a particular tilting angle, adjust chair to desired position, then push lever backward to lock into place. To release, pull lever forward, then lean into chair back. This mechanism also includes an anti-kick feature that prevents chair back from jolting forward when Tilt-Lock position is released.
3. Optional Seat Slider adjustment provides 2½" front and back horizontal seat depth adjustment. To operate, lift up on adjustment bar and move seat forward or backward until desired depth is achieved. Release bar and seat will lock into position.

Synchro-Tilt

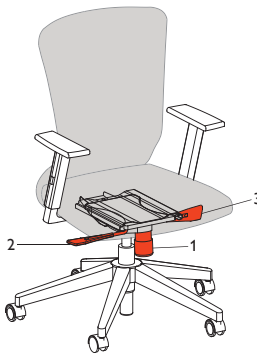

1. Tension Control Knob allows for greater spring tension control for a firmer or softer tilting motion. Turn counter-clockwise to increase tension, clockwise to decrease tension.
2. Seat Height Adjustment easily raises or lowers seat to desired height. To raise, lift weight off seat and pull upward on lever until seat reaches a comfortable height. To lower, lift upward on lever while seated and release to lock seat into desired position.
3. Multi-Position Tilt Lock Lever allows back to be secured into a tilt position, locked entirely, or enables it to free-float. To secure chair into tilted position, adjust back to a moderately reclined angle, then push downward on lever to middle position to lock into place. To lock at an upright angle, pull lever into uppermost position. To release and free-float, push lever downward to its lowest position.

Synchro-Tilt with Seat Slider

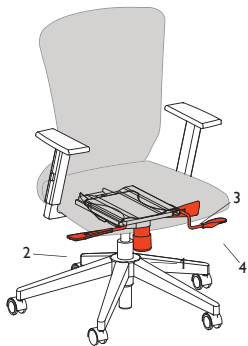

1. Tension Control Knob allows for greater spring tension control for a firmer or softer tilting motion. Turn counter-clockwise to increase tension, clockwise to decrease tension.
2. Seat Height Adjustment easily raises or lowers seat to desired height. To raise, lift weight off seat and pull upward on lever until seat reaches a comfortable height. To lower, lift upward on lever while seated and release to lock seat into desired position.
3. Multi-Position Tilt Lock Lever allows back to be secured into a tilt position, locked entirely, or enables it to free-float. To secure chair into tilted position, adjust back to a moderately reclined angle, then push downward on lever to middle position to lock into place. To lock at an upright angle, pull lever into uppermost position. To release and free-float, push lever downward to its lowest position.
4. Seat Slider adjustment provides 2½" front and back horizontal seat depth adjustment. To operate, lift up on adjustment bar and move seat forward or backward until desired depth is achieved. Release bar and seat will lock into position.

Task Intensive

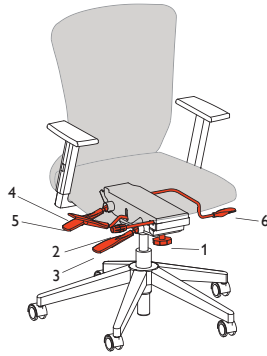

1. Tension Control Knob allows for greater spring tension control for a firmer or softer tilting motion. Turn counter-clockwise to increase tension, clockwise to decrease tension.
2. Front Tilt Stop Lever allows additional forward tilt for optimum task performance. To operate, first release Tilt Lock with Infinite Lock by pulling up on the mechanism, then tilt seat backward slightly and push front tilt stop lever downward and back. To return chair to upright position, tilt seat back once again and pull front tilt stop lever forward and up to its original location.
3. Tilt Lock with Infinite Lock Lever secures seat into any position or allows seat to free float. To lock into a particular position, tilt seat to desired angle and press down on lever. To release, simply lift lever up.
4. Seat Height Adjustment easily raises or lowers seat to desired height. To raise, lift weight off seat and pull upward on lever until seat reaches a comfortable height. To lower, lift upward on lever while seated and release to lock seat into desired position.
5. Back Angle with Infinite Lock Lever provides precise back angle control. To adjust, lift up on lever until desired back angle is reached. To freely make adjustments without touching lever, move lever into highest position, adjust back angle, then push lever downward to lock into place.
6. Optional Seat Slider adjustment provides 2½" front and back horizontal seat depth adjustment. To operate, lift up on adjustment bar and move seat forward or backward until desired depth is achieved. Release bar and seat will lock into position.

Weight-Activated

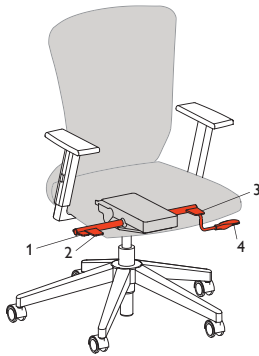

1. Tension Lever allows for greater spring tension control for a firmer or softer tilting motion. Push downward and back to increase tension, pull forward and up to decrease tension.
2. Seat Height Adjustment easily raises or lowers seat to desired height. To raise, lift weight off seat and pull upward on lever until seat reaches a comfortable height. To lower, lift upward on lever while seated and release to lock seat into desired position.
3. Multi-Position Tilt Lock Lever allows back to be secured into a tilt position, locked entirely, or enables it to free-float. To secure chair into tilted position, adjust back to a moderately reclined angle, then push downward on lever to middle position to lock into place. To lock at an upright angle, pull lever into uppermost position. To release and free-float, push lever downward to its lowest position.
4. Optional Seat Slider adjustment provides 2½" front and back horizontal seat depth adjustment. To operate, lift up on adjustment bar and move seat forward or backward until desired depth is achieved. Release bar and seat will lock into position.

Weight-Activated Synchro-Tilt

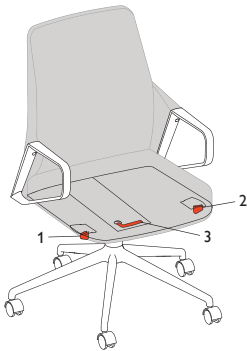

1. Seat Height Adjustment easily raises or lowers seat to desired height. To raise, lift weight off seat and push backwards on lever until seat reaches a comfortable height. To lower, push backwards on lever while seated and release to lock seat into desired position.
2. Tilt-Lock Lever allows back to be secured into a tilt position, locked entirely, or enables it to free-float. To secure chair into tilted position, adjust back to moderately reclined angle, then push backward on lever to lock into place. To release and free-float, push lever forward. Chair tilt may also be locked upright at starting position, if desired.
3. Tension Hex Key allows for greater spring tension control for a firmer or softer tilting motion. Insert key in opening and turn clockwise to increase tension, counter-clockwise to decrease tension.

OPTIONS

Providing further customization capability for individual needs, Encore offers a variety of options on most task and executive seating models, as listed below. Please refer to price list pages on individual models for availability as well as additional options that may be offered.

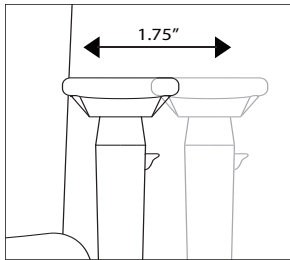

Width Adjustable Arms
1¾" horizontal adjustment per arm.

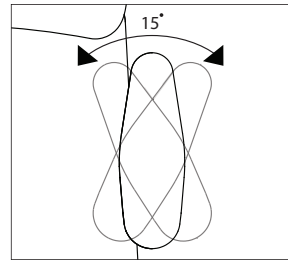

Pivot Arms
15-degree horizontal swivel arm pad adjustment inward or outward.

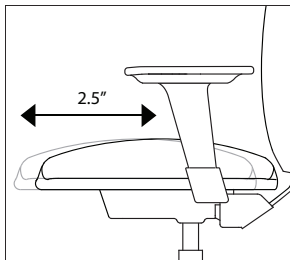

Seat Slider
2½" front and back horizontal seat depth adjustment.

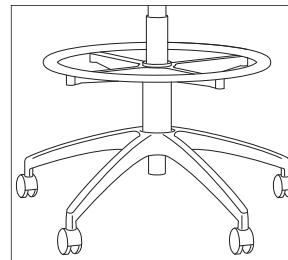

Stool Option
Extended 10" lift.

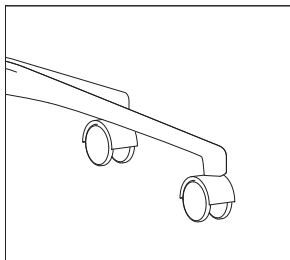

Soft Tread Casters
55mm diameter soft rubber wheels for hard surface floors.

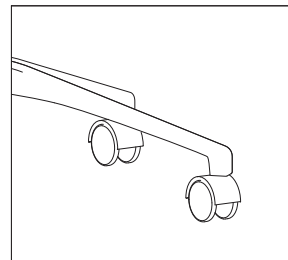

Soft Tread Self-Locking Casters
Lock upon standing and release when sitting.

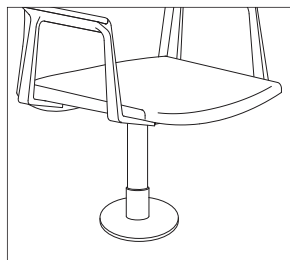

Jury Base
Satin Black finish.

CHANCE GUEST | Designed by Francisco Romero of PhiDesign



SPECIFICATIONS:

- Arm and armless models available fully upholstered or with maple wood back.
- Fully upholstered bariatric models with enhanced seat and back size also available.
- Maple wood back available in all standard finishes. Please refer to standard finish card.
- Arms feature black finish as standard.
- Silver arm finish also available. Please specify (-SA01) after model number and add \$22 list.
- Round tubular steel frame.
- Frame available in standard and premium finishes. See below for options.
- For custom finish colors, please contact client services for pricing.
- Wall-saver leg design.
- Available with glides or on casters.
- Chairs with glides or casters stack up to 4 high standing or 5 with dolly.
- Optional ganging device available.
- Chairs are packaged three (3) to a carton.
- \$20 List carton break charge for less than three (3) chairs.
- Orders for thirty (30) or more chairs will not be subject to carton break upcharge.
- Guest chairs feature 300 lb. weight capacity.
- Bariatric models feature 500 lb. weight capacity.
- Refer to terms and conditions for general information regarding fabrics, finishes, warranty, freight, complete condition of sales and more.

STANDARD METAL FRAME FINISH COLORS:

- #06 Charcoal Grey
- #90 Metallic Silver
- #95 Satin Black

PREMIUM METAL FRAME FINISH COLORS:





- #07 Gold Shimmer
- #08 Penny
- #09 Brown Sugar
- #83 Metallic Champagne
- #94 Cotton

CHANCE GUEST | Designed by Francisco Romero of PhiDesign



ORDERING REQUIREMENTS:

- Model number
- Arm finish, as applicable
- Frame finish
- Upholstery selection
- Options, as applicable

MODEL	PRODUCT SPECIFICATIONS	FABRIC GRADES										LEATHER	
		COM	A	1	2	3	4	COL 5	6	7	8	L1	L2
2510 	Guest Chair, Fully Upholstered Arms, Glides 23.5" W x 23.5" D x 31" H Seat: 18.5" W x 18.5" D Seat Ht: 17.75" Arm Ht: 26" COM: 1.25 yds. COL: 25 sq. ft. 22 lbs.	448	498	533	553	588	625	658	693	726	762	925	1,043
2515 	Guest Chair, Fully Upholstered Arms, Casters 23.5" W x 23.5" D x 31" H Seat: 18.5" W x 18.5" D Seat Ht: 17.75" Arm Ht: 26" COM: 1.25 yds. COL: 25 sq. ft. 22 lbs.	448	498	533	553	588	625	658	693	726	762	925	1,043
2530 	Guest Chair, Fully Upholstered Armless, Glides 21" W x 23.5" D x 31" H Seat: 18.5" W x 18.5" D Seat Ht: 17.75" COM: 1.25 yds. COL: 25 sq. ft. 20 lbs.	413	463	498	518	553	590	623	658	691	727	890	1,008
2535 	Guest Chair, Fully Upholstered Armless, Casters 21" W x 23.5" D x 31" H Seat: 18.5" W x 18.5" D Seat Ht: 17.75" COM: 1.25 yds. COL: 25 sq. ft. 20 lbs.	426	476	511	531	566	603	636	671	704	740	903	1,021

OPTIONS





-PF02	Premium Metal Frame Finish	\$80	-STC02	Soft Tread Casters	\$26
-SA01	Silver Arms	\$22	-VCT04	VCT Tile Glides	\$24
-FS01	1" Additional Seat Foam	\$30	-MB01	Moisture Barrier (seat only)	\$52
-GC01	Ganging Connector	\$30			

All shipments for this series will be blanket-wrapped as standard. If cartoning is required, a 5% upcharge will be added to each product. Please contact client services for additional information.

CHANCE GUEST | Designed by Francisco Romero of PhiDesign

ORDERING REQUIREMENTS:

- Model number
- Back finish
- Arm finish, as applicable
- Frame finish
- Upholstery selection
- Options, as applicable

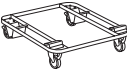
MODEL	PRODUCT SPECIFICATIONS	FABRIC GRADES										LEATHER	
		COM	A	1	2	3	4	COL 5	6	7	8	L1	L2
2511 	Guest Chair, Wood Back Arms, Glides 23.5" W x 23.5" D x 31" H Seat: 18.5" W x 18.5" D Seat Ht: 17.75" Arm Ht: 26" COM: .75 yd. COL: 15 sq. ft. 20 lbs.	536	566	587	599	620	642	662	683	703	725	822	893
2516 	Guest Chair, Wood Back Arms, Casters 23.5" W x 23.5" D x 31" H Seat: 18.5" W x 18.5" D Seat Ht: 17.75" Arm Ht: 26" COM: .75 yd. COL: 15 sq. ft. 20 lbs.	532	562	583	595	616	638	658	679	699	721	818	889
2531 	Guest Chair, Wood Back Armless, Glides 21" W x 23.5" D x 31" H Seat: 18.5" W x 18.5" D Seat Ht: 17.75" Arm Ht: 26" COM: .75 yd. COL: 15 sq. ft. 18 lbs.	495	525	546	558	579	601	621	642	662	684	781	852
2536 	Guest Chair, Wood Back Armless, Casters 21" W x 23.5" D x 31" H Seat: 18.5" W x 18.5" D Seat Ht: 17.75" Arm Ht: 26" COM: .75 yd. COL: 15 sq. ft. 18 lbs.	497	527	548	560	581	603	623	644	664	686	783	854
2500 	Dolly (Black Finish Only) 24" W x 30" D x 6" H 37 lbs.	337											

OPTIONS

-PF02	Premium Metal Frame Finish	\$80	-STC02	Soft Tread Casters	\$26
-SA01	Silver Arms	\$22	-VCT04	VCT Tile Glides	\$24
-FS01	1" Additional Seat Foam	\$30	-MB01	Moisture Barrier (seat only)	\$52
-GC01	Ganging Connector	\$30			

All shipments for this series will be blanket-wrapped as standard. If cartoning is required, a 5% upcharge will be added to each product. Please contact client services for additional information.

CHANCE GUEST | Designed by Francisco Romero of PhiDesign

ORDERING REQUIREMENTS:

- Model number
- Arm finish, as applicable
- Frame finish
- Upholstery selection
- Options, as applicable

MODEL	PRODUCT SPECIFICATIONS	FABRIC GRADES										LEATHER	
		COM	A	1	2	3	4	COL 5	6	7	8	L1	L2
2580 	Bariatric Chair, Fully Upholstered Arms, Glides 34.5" W x 24.5" D x 32" H Seat: 30" W x 19" D Seat Ht: 18" Arm Ht: 26" COM: 2.5 yds. COL: 50 sq. ft. 50 lbs.	924	1,024	1,094	1,134	1,204	1,277	1,344	1,414	1,479	1,552	1,877	2,114

OPTIONS

-PF02	Premium Metal Frame Finish	\$80
-SA01	Silver Arms	\$22
-FS01	1" Additional Seat Foam	\$30
-VCT04	VCT Tile Glides	\$24
-MB02	Moisture Barrier (seat only)	\$70

CHANCE GUEST | Designed by Francisco Romero of PhiDesign

UPHOLSTERY COMBINATIONS:

- For upholstery combinations, refer to the pricing below.
- When combining two COM/COV/COL fabrics, or fabrics with the same grade, add \$85 List per unit.
- When combining three or more COM/COV/COL fabrics, or fabrics with the same grade, add \$115 List per unit.
- When combining different grades of fabric, price will be based on the highest grade specified.
- Two-tone upholstery examples and yardage requirements for the most common combinations are listed below. Additional combinations available; please contact Client Services for yardage requirements and pricing.
- Note: Yardage amounts are based on fabric which is plain (i.e. non-directional) and a full 54" wide.
- Appropriate upholstery code must be included.



Code	CS1
<u>Model</u>	<u>COM Requirement</u>
2510	Back = .75 yd.
2515	Seat = .5 yd.
2530	
2535	

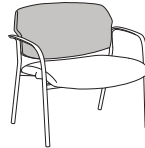

Code	CS3
<u>Model</u>	<u>COM Requirement</u>
2580	Back = 1.25 yds.
	Seat = 1.25 yds.

CHANCE STOOLS | Designed by Francisco Romero of PhiDesign



SPECIFICATIONS:

- Fully upholstered seat and back.
- Arm and armless models.
- Arms feature black finish as standard.
- Silver arm finish also available. Please specify (-SA01) after model number and add \$22 list.
- Round tubular steel frame.
- Frame available in standard and premium finishes. See below for options.
- For custom finish colors, please contact client services for pricing.
- Wall-saver leg design.
- 30" Bar Height Stool features footrest with 12" clearance from floor.
- 27" Counter Height Stool features footrest with 9" clearance from floor.
- Armless models stack up to 4 high from the floor.
- 300 lb. weight capacity.
- All dimensions are nominal.
- Refer to terms and conditions for general information regarding fabrics, finishes, warranty, freight, complete condition of sales and more.

STANDARD METAL FRAME FINISH COLORS:

- #06 Charcoal Grey
- #90 Metallic Silver
- #95 Satin Black

PREMIUM METAL FRAME FINISH COLORS:





- #07 Gold Shimmer
- #08 Penny
- #09 Brown Sugar
- #83 Metallic Champagne
- #94 Cotton

All shipments for this series will be blanket-wrapped as standard. If cartoning is required, a 5% upcharge will be added to each product. Please contact client services for additional information.

CHANCE STOOLS | Designed by Francisco Romero of PhiDesign

ORDERING REQUIREMENTS:

- Model number
- Arm finish, as applicable
- Frame finish
- Upholstery selection
- Options, as applicable

MODEL	PRODUCT SPECIFICATIONS	FABRIC GRADES								LEATHER			
		COM	A	1	2	3	4	COL 5	6	7	8	L1	L2
2560 	Bar-Height Stool, Fully Upholstered Arms, Glides 23.5" W x 24" D x 41" H Seat: 18.5" W x 20" D Seat Ht: 30" Arm Ht: 37.5" COM: 1.25 yds. COL: 25 sq. ft. 28 lbs.	603	653	688	708	743	780	813	848	881	917	1,080	1,198
2563 	Bar-Height Stool, Fully Upholstered Armless, Glides 20.5" W x 24" D x 41" H Seat: 18.5" W x 20" D Seat Ht: 30" COM: 1.25 yds. COL: 25 sq. ft. 25 lbs.	582	632	667	687	722	759	792	827	860	896	1,059	1,177
2570 	Counter-Height Stool, Fully Upholstered Arms, Glides 23.5" W x 24" D x 38" H Seat: 18.5" W x 20" D Seat Ht: 27" Arm Ht: 34.5" COM: 1.25 yds. COL: 25 sq. ft. 28 lbs.	598	648	683	703	738	775	808	843	876	912	1,075	1,193
2573 	Counter-Height Stool, Fully Upholstered Armless, Glides 20.5" W x 24" D x 38" H Seat: 18.5" W x 20" D Seat Ht: 27" COM: 1.25 yds. COL: 25 sq. ft. 25 lbs.	577	627	662	682	717	754	787	822	855	891	1,054	1,172

OPTIONS

-PF02	Premium Metal Frame Finish	\$80
-SA01	Silver Arms	\$22
-FS01	1" Additional Seat Foam	\$30
-VCT04	VCT Tile Glides	\$24
-MB01	Moisture Barrier (seat only)	\$52

CHANCE STOOLS | Two-Tone Upholstery

UPHOLSTERY COMBINATIONS:

- For upholstery combinations, refer to the pricing below.
- When combining two COM/COV/COL fabrics, or fabrics with the same grade, add \$85 List per unit.
- When combining three or more COM/COV/COL fabrics, or fabrics with the same grade, add \$115 List per unit.
- When combining different grades of fabric, price will be based on the highest grade specified.
- Two-tone upholstery examples and yardage requirements for the most common combinations are listed below. Additional combinations available; please contact client services for yardage requirements and pricing.
- Note: Yardage amounts are based on fabric which is plain (i.e. non-directional) and a full 54" wide.
- Appropriate upholstery code must be included.



Code	CS2
<u>Model</u>	<u>COM Requirement</u>
2560	Back = .75 yd.
2563	Seat = .5 yd.
2570	
2573	

CHIRP GUEST



SPECIFICATIONS:

- Three base options available: sled base, swivel base with self-return or wood legs.
- Sled and swivel base available in standard and premium finishes. See below for options.
- For custom finish colors, please contact client services for pricing.
- 300 lb. weight capacity.
- Fixed wood legs offered in all standard finishes on beech. Please refer to standard finish card.
- For custom wood finishes, please add \$450 List per color per order.
- All dimensions are nominal.
- Refer to terms and conditions for general information regarding fabrics, finishes, warranty, freight, complete condition of sales and more.

STANDARD METAL BASE FINISH COLORS:

- #06 Charcoal Grey
- #90 Metallic Silver
- #91 Chrome (sled base only)
- #92 Polished Aluminum (swivel base only)
- #95 Satin Black

PREMIUM METAL BASE FINISH COLORS:



- #07 Gold Shimmer
- #08 Penny
- #09 Brown Sugar
- #83 Metallic Champagne
- #94 Cotton

All shipments for this series will be blanket-wrapped as standard. If cartoning is required, a 5% upcharge will be added to each product. Please contact client services for additional information.

CHIRP GUEST

ORDERING REQUIREMENTS:

- Model number
- Base finish
- Upholstery selection
- Options, as applicable

MODEL	PRODUCT SPECIFICATIONS	FABRIC GRADES										LEATHER	
		COM	A	1	2	3	4	COL 5	6	7	8	L1	L2
30112 	Guest Chair, Sled Base 21.75" W x 23" D x 32" H Seat: 19.75" W x 17" D Seat Ht: 18" COM: 1.5 yds. COL: 30 sq. ft. 18 lbs.	831	891	933	957	999	1,043	1,083	1,125	1,164	1,208	1,403	1,545
30113 	Guest Chair, Swivel Base 20.5" W x 23" D x 31.75" H Seat: 19.75" W x 17" D Seat Ht: 17.75" COM: 1.5 yds. COL: 30 sq. ft. 22 lbs.	955	1,015	1,057	1,081	1,123	1,167	1,207	1,249	1,288	1,332	1,527	1,669
30114 	Guest Chair, Wood Legs 20.5" W x 23" D x 31.75" H Seat: 19.75" W x 17" D Seat Ht: 17.75" COM: 1.5 yds. COL: 30 sq. ft. 17 lbs.	991	1,051	1,093	1,117	1,159	1,203	1,243	1,285	1,324	1,368	1,563	1,705

OPTIONS

-PF02	Premium Metal Base Finish	\$80
-CG02	Clear Glides (sled base models only)	\$10
-FG04	Felt Glides (sled base and wood leg models only)	\$40
-NS04	Non-Skid Glides (sled base and wood leg models only)	\$42

CHIRP GUEST

UPHOLSTERY COMBINATIONS:

- For upholstery combinations, refer to the pricing below.
- When combining two COM/COV/COL fabrics, or fabrics with the same grade, add \$85 List per unit.
- When combining three or more COM/COV/COL fabrics, or fabrics with the same grade, add \$115 List per unit.
- When combining different grades of fabric, price will be based on the highest grade specified.
- Two-tone upholstery examples and yardage requirements for the most common combinations are listed below. Additional combinations available; please contact Client Services for yardage requirements and pricing.
- Note: Yardage amounts are based on fabric which is plain (i.e. non-directional) and a full 54" wide.
- Appropriate upholstery code must be included.



Code	CH1
<u>Model</u>	<u>COM Requirement</u>
30112	Side/Front Panels = .75 yd.
30113	Balance of Chair = 1.25 yds.
30114	



Code	CH2
<u>Model</u>	<u>COM Requirement</u>
30112	Seat Front/Back Front = .75 yd.
30113	Balance of Chair = 1 yd.
30114	



Code	CH3
<u>Model</u>	<u>COM Requirement</u>
30112	Seat Front/Back Front/
30113	Side & Front Panels = 1.25 yds.
30114	Balance of Chair = .75 yd.

CHIRP LOUNGE



SPECIFICATIONS:

- Two base options available: sled base and swivel base with self-return.
- Bases available in standard and premium finishes. See below for options.
- For custom finish colors, please contact client services for pricing.
- 300 lb. weight capacity.
- All dimensions are nominal.
- Refer to terms and conditions for general information regarding fabrics, finishes, warranty, freight, complete condition of sales and more.

STANDARD METAL BASE FINISH COLORS:

- #06 Charcoal Grey
- #90 Metallic Silver
- #91 Chrome (sled base only)
- #92 Polished Aluminum (swivel base only)
- #95 Satin Black

PREMIUM METAL BASE FINISH COLORS:



- #07 Gold Shimmer
- #08 Penny
- #09 Brown Sugar
- #83 Metallic Champagne
- #94 Cotton

All shipments for this series will be blanket-wrapped as standard. If cartoning is required, a 5% upcharge will be added to each product. Please contact client services for additional information.

CHIRP LOUNGE

ORDERING REQUIREMENTS:

- Model number
- Base finish
- Upholstery selection
- Options, as applicable

MODEL	PRODUCT SPECIFICATIONS	FABRIC GRADES										LEATHER	
		COM	A	1	2	3	4	COL 5	6	7	8	L1	L2
30212-M 	Mid-Back Lounge Chair, Sled Base 26.5" W x 24.25" D x 30" H Seat: 22.5" W x 17" D Seat Ht: 16.5" COM: 1.75 yds. COL: 35 sq. ft. 20 lbs.	939	1,009	1,058	1,086	1,135	1,186	1,233	1,282	1,328	1,379	1,606	1,772
30213-M 	Mid-Back Lounge Chair, Swivel Base 23" W x 24.25" D x 30" H Seat: 22.5" W x 17" D Seat Ht: 16.5" COM: 1.75 yds. COL: 35 sq. ft. 22 lbs.	1,062	1,132	1,181	1,209	1,258	1,309	1,356	1,405	1,451	1,502	1,729	1,895

OPTIONS



-PF02	Premium Metal Base Finish	\$80
-CG02	Clear Glides (sled base models only)	\$10
-FG04	Felt Glides (sled base models only)	\$40
-NS04	Non-Skid Glides (sled base models only)	\$42

All shipments for this series will be blanket-wrapped as standard. If cartoning is required, a 5% upcharge will be added to each product. Please contact client services for additional information.

CHIRP LOUNGE

ORDERING REQUIREMENTS:

- Model number
- Base finish
- Upholstery selection
- Options, as applicable

MODEL	PRODUCT SPECIFICATIONS	FABRIC GRADES								LEATHER			
		COM	A	1	2	3	4	COL 5	6	7	8	L1	L2
30212-H 	High Back Lounge Chair, Sled Base 26.5" W x 24.25" D x 38" H Seat: 22.5" W x 17" D Seat Ht: 16.5" COM: 2 yds. COL: 40 sq. ft. 24 lbs.	1,005	1,085	1,141	1,173	1,229	1,287	1,341	1,397	1,449	1,507	1,767	1,957
30213-H 	High Back Lounge Chair, Swivel Base 23" W x 24.25" D x 38" H Seat: 22.5" W x 17" D Seat Ht: 16.5" COM: 2 yds. COL: 40 sq. ft. 26 lbs.	1,130	1,210	1,266	1,298	1,354	1,412	1,466	1,522	1,574	1,632	1,892	2,082

OPTIONS

-PF02	Premium Metal Base Finish	\$80
-CG02	Clear Glides (sled base models only)	\$10
-FG04	Felt Glides (sled base models only)	\$40
-NS04	Non-Skid Glides (sled base models only)	\$42

CHIRP LOUNGE

UPHOLSTERY COMBINATIONS:

- For upholstery combinations, refer to the pricing below.
- When combining two COM/COV/COL fabrics, or fabrics with the same grade, add \$85 List per unit.
- When combining three or more COM/COV/COL fabrics, or fabrics with the same grade, add \$115 List per unit.
- When combining different grades of fabric, price will be based on the highest grade specified.
- Two-tine upholstery examples and yardage requirements for the most common combinations are listed below. Additional combinations available; please contact Client Services for yardage requirements and pricing.
- Note: Yardage amounts are based on fabric which is plain (i.e. non-directional) and a full 54" wide.
- Appropriate upholstery code must be included.



Code	CH4
<u>Model</u>	<u>COM Requirement</u>
30212-M	Side/Front Panels = .75 yd.
30213-M	Balance of Chair = 1.5 yds.



Code	CH5
<u>Model</u>	<u>COM Requirement</u>
30212-M	Seat Front/Back Front = .75 yd.
30213-M	Balance of Chair = 1 yd.

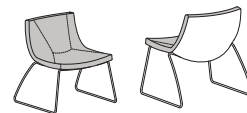

Code	CH6
<u>Model</u>	<u>COM Requirement</u>
30212-M	Seat Front/Back Front/ Side & Front Panels = 1.25 yds.
30213-M	Balance of Chair = .75 yd.



Code	CH7
<u>Model</u>	<u>COM Requirement</u>
30212-H	Side/Front Panels = .75 yd.
30213-H	Balance of Chair = 1.5 yds.



Code	CH8
<u>Model</u>	<u>COM Requirement</u>
30212-H	Seat Front/Back Front = .75 yd.
30213-H	Balance of Chair = 1.25 yds.

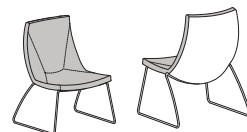

Code	CH9
<u>Model</u>	<u>COM Requirement</u>
30212-H	Seat Front/Back Front/ Side & Front Panels = 1.5 yds.
30213-H	Balance of Chair = .75 yd.

CHIRP STOOLS



SPECIFICATIONS:

- Bar and counter-height models.
- ½" diameter steel rod frame.
- Frame available in standard and premium finishes. See below for options.
- For custom finish colors, please contact client services for pricing.
- 30" bar-height stool features footrest with 11.5" clearance from the floor.
- 27" counter-height stool features footrest with 10" clearance from the floor.
- 300 lb. weight capacity.
- Optional glides for hard surface flooring.
- 300 lb. weight capacity.
- All dimensions are nominal.
- Refer to terms and conditions for general information regarding fabrics, finishes, warranty, freight, complete condition of sales and more.

STANDARD METAL FRAME FINISH COLORS:

- #06 Charcoal Grey
- #90 Metallic Silver
- #91 Chrome
- #95 Satin Black

PREMIUM METAL FRAME FINISH COLORS:



- #07 Gold Shimmer
- #08 Penny
- #09 Brown Sugar
- #83 Metallic Champagne
- #94 Cotton

All shipments for this series will be blanket-wrapped as standard. If cartoning is required, a 5% upcharge will be added to each product. Please contact client services for additional information.

CHIRP STOOLS

ORDERING REQUIREMENTS:

- Model number
- Frame finish
- Upholstery selection
- Options, as applicable

MODEL	PRODUCT SPECIFICATIONS	FABRIC GRADES								LEATHER			
		COM	A	1	2	3	4	COL 5	6	7	8	L1	L2
30612-27 	Counter-Height Stool 19.75" W x 20.5" D x 35.5" H Seat: 16" W x 14" D Seat Ht: 27" COM: 1 yd. COL: 20 sq. ft. 14 lbs.	837	877	905	921	949	978	1,005	1,033	1,059	1,088	1,218	1,313
30612-30 	Bar-Height Stool 19.75" W x 20.5" D x 38.5" H Seat: 16" W x 14" D Seat Ht: 30" COM: 1 yd. COL: 20 sq. ft. 16 lbs.	853	893	921	937	965	994	1,021	1,049	1,075	1,104	1,234	1,329

OPTIONS

-PF02	Premium Metal Frame Finish	\$80
-CG02	Clear Glides	\$10
-FG04	Felt Glides	\$40

CHIRP STOOLS

UPHOLSTERY COMBINATIONS:

- For upholstery combinations, refer to the pricing below.
- When combining two COM/COV/COL fabrics, or fabrics with the same grade, add \$85 List per unit.
- When combining three or more COM/COV/COL fabrics, or fabrics with the same grade, add \$115 List per unit.
- When combining different grades of fabric, price will be based on the highest grade specified.
- Two-tine upholstery examples and yardage requirements for the most common combinations are listed below. Additional combinations available; please contact client services for yardage requirements and pricing.
- Note: Yardage amounts are based on fabric which is plain (i.e. non-directional) and a full 54" wide.
- Appropriate upholstery code must be included.



Code	CH10
<u>Model</u>	<u>COM Requirement</u>
30612-27	Side/Front Panels = .5 yd.
30612-30	Balance of Chair = .75 yd.



Code	CH11
<u>Model</u>	<u>COM Requirement</u>
30612-27	Seat Front/Back Front = .5 yd.
30612-30	Balance of Chair = .5 yd.



Code	CH12
<u>Model</u>	<u>COM Requirement</u>
30612-27	Seat Front/Back Front/ Side & Front Panels = .75 yd.
30612-30	Balance of Chair = .5 yd.

CIELO® BENCHES | Designed by Chris Panichella



SPECIFICATIONS:

- Fully upholstered seat available with or without horizontal channel stitching.
- 3/4" diameter tubular steel frame.
- Frame available in standard and premium finishes. See below for options.
- For custom finish colors, please contact client services for pricing.
- 600 lb. weight capacity.
- All dimensions are nominal.
- Refer to terms and conditions for general information regarding fabrics, finishes, warranty, freight, complete condition of sales and more.

STANDARD METAL FRAME FINISH COLORS:

- #06 Charcoal Grey
- #90 Metallic Silver
- #91 Chrome
- #95 Satin Black

PREMIUM METAL FRAME FINISH COLORS:

- #07 Gold Shimmer
- #08 Penny
- #09 Brown Sugar
- #83 Metallic Champagne
- #94 Cotton

All shipments for this series will be blanket-wrapped as standard. If cartoning is required, a 5% upcharge will be added to each product. Please contact client services for additional information.

CIELO® BENCHES | Designed by Chris Panichella

ORDERING REQUIREMENTS:

- Model number
- Base finish
- Upholstery selection
- Options, as applicable

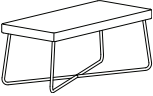
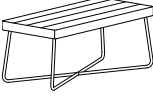
MODEL	PRODUCT SPECIFICATIONS	FABRIC GRADES										LEATHER	
		COM	A	1	2	3	4	COL 5	6	7	8	L1	L2
8090 	43" Wide Bench 43.5" W x 20.5" D x 18" H COM: 1.75 yds. COL: 35 sq. ft. 25 lbs.	947	1,017	1,066	1,094	1,143	1,194	1,241	1,290	1,336	1,387	1,614	1,780
8092 	43" Wide Bench, Channel Upholstery 43.5" W x 20.5" D x 18" H COM: 1.75 yds. COL: 35 sq. ft. 25 lbs.	1,078	1,148	1,197	1,225	1,274	1,325	1,372	1,421	1,467	1,518	1,745	1,911

OPTIONS

-PF02	Premium Metal Frame Finish	\$80
-NS04	Non-Skid Glides	\$42
-MB02	Moisture Barrier	\$73

All shipments for this series will be blanket-wrapped as standard. If cartoning is required, a 5% upcharge will be added to each product. Please contact client services for additional information.

CIELO® LOUNGE | Designed by Chris Panichella



SPECIFICATIONS:

- Lounge and love seat models.
- Sled base comprised of 3/4" diameter tubular steel.
- Swivel base lounge chairs also offered.
- Swivel base models feature self-return.
- Fully upholstered seat and back available with or without horizontal channel stitching.
- Sled and swivel base offered in standard and premium finishes. See below for options.
- For custom finish colors, please contact client services for pricing.
- Lounge chair features 350 lb. weight capacity.
- Love seat features 600 lb. weight capacity.
- All dimensions are nominal.
- Refer to terms and conditions for general information regarding fabrics, finishes, warranty, freight, complete condition of sales and more.

STANDARD METAL BASE FINISH COLORS:

- #06 Charcoal Grey
- #90 Metallic Silver
- #91 Chrome (sled base only)
- #92 Polished Aluminum (swivel base only)
- #95 Satin Black

PREMIUM METAL BASE FINISH COLORS:





- #07 Gold Shimmer
- #08 Penny
- #09 Brown Sugar
- #83 Metallic Champagne
- #94 Cotton

All shipments for this series will be blanket-wrapped as standard. If cartoning is required, a 5% upcharge will be added to each product. Please contact client services for additional information.

CIELO® LOUNGE | Designed by Chris Panichella

ORDERING REQUIREMENTS:

- Model number
- Base finish
- Upholstery selection
- Options, as applicable

MODEL	PRODUCT SPECIFICATIONS	FABRIC GRADES								LEATHER			
		COM	A	1	2	3	4	COL 5	6	7	8	L1	L2
8070 	Lounge Chair, Sled Base 22.5" W x 27.25" D x 30.5" H Seat: 22.5" W x 17" D Seat Ht: 17" COM: 1.75 yds. COL: 35 sq. ft. 25 lbs.	1,008	1,078	1,127	1,155	1,204	1,255	1,302	1,351	1,397	1,448	1,675	1,841
8072 	Lounge Chair, Sled Base, Channel Upholstery 22.5" W x 27.25" D x 30.5" H Seat: 22.5" W x 17" D Seat Ht: 17" COM: 1.75 yds. COL: 35 sq. ft. 25 lbs.	1,091	1,161	1,210	1,238	1,287	1,338	1,385	1,434	1,480	1,531	1,758	1,924
8080 	Love Seat, Sled Base 44.5" W x 27.25" D x 30.5" H Seat: 44.5" W x 17" D Seat Ht: 17" COM: 2.75 yds. COL: 55 sq. ft. 40 lbs.	1,492	1,602	1,679	1,723	1,800	1,880	1,954	2,031	2,103	2,183	2,540	2,801
8082 	Love Seat, Sled Base, Channel Upholstery 44.5" W x 27.25" D x 30.5" H Seat: 44.5" W x 17" D Seat Ht: 17" COM: 2.75 yds. COL: 55 sq. ft. 40 lbs.	1,680	1,790	1,867	1,911	1,988	2,068	2,142	2,219	2,291	2,371	2,728	2,989

OPTIONS



-PF02	Premium Metal Base Finish	\$80	-MB02	Moisture Barrier (love seat, seat only)	\$73
-MB01	Moisture Barrier (lounge, seat only)	\$52	-NS04	Non-Skid Glides	\$42

All shipments for this series will be blanket-wrapped as standard. If cartoning is required, a 5% upcharge will be added to each product. Please contact client services for additional information.

CIELO® LOUNGE | Designed by Chris Panichella

ORDERING REQUIREMENTS:

- Model number
- Base finish
- Upholstery selection
- Options, as applicable

MODEL	PRODUCT SPECIFICATIONS	FABRIC GRADES								LEATHER			
		COM	A	1	2	3	4	COL 5	6	7	8	L1	L2
8075 	Lounge Chair, Swivel Base 28" W x 27.25" D x 30.5" H Seat: 22.5" W x 17" D Seat Ht: 17" COM: 1.75 yds. COL: 35 sq. ft. 32 lbs.	1,216	1,286	1,335	1,363	1,412	1,463	1,510	1,559	1,605	1,656	1,883	2,049
8077 	Lounge Chair, Swivel Base, Channel Upholstery 28" W x 27.25" D x 30.5" H Seat: 22.5" W x 17" D Seat Ht: 17" COM: 1.75 yds. COL: 35 sq. ft. 32 lbs.	1,322	1,392	1,441	1,469	1,518	1,569	1,616	1,665	1,711	1,762	1,989	2,155

OPTIONS

- PF02 Premium Metal Base Finish \$80
- NS04 Non-Skid Glides \$42
- MB01 Moisture Barrier (lounge, seat only) \$52

CIELO® LOUNGE | Designed by Chris Panichella

UPHOLSTERY COMBINATIONS:

- For upholstery combinations, refer to the pricing below.
- When combining two COM/COV/COL fabrics, or fabrics with the same grade, add \$85 List per unit.
- When combining three or more COM/COV/COL fabrics, or fabrics with the same grade, add \$115 List per unit.
- When combining different grades of fabric, price will be based on the highest grade specified.
- Two-tine upholstery examples and yardage requirements for the most common combinations are listed below. Additional combinations available; please contact client services for yardage requirements and pricing.
- Note: Yardage amounts are based on fabric which is plain (i.e. non-directional) and a full 54" wide.
- Appropriate upholstery code must be included.



Code	CC1
Model	COM Requirement
8070	Seat Front & Back Front = .75 yd.
8072	Balance of Chair = 1.5 yds.

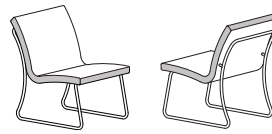

Code	CC2
Model	COM Requirement
8070	Band = .75 yd.
8072	Balance of Chair = 1.5 yds.



Code	CC3
Model	COM Requirement
8075	Seat Front & Back Front = .75 yd.
8077	Balance of Chair = 1.5 yds.



Code	CC4
Model	COM Requirement
8075	Band = .75 yd.
8077	Balance of Chair = 1.5 yds.



Code	CC5
Model	COM Requirement
8080	Seat Front & Back Front = 1 yd.
8082	Balance of Chair = 1.75 yds.

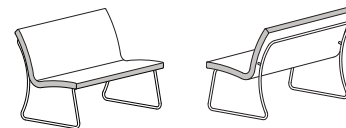

Code	CC6
Model	COM Requirement
8080	Band = .75 yd.
8082	Balance of Chair = 2 yds.

All shipments for this series will be blanket-wrapped as standard. If cartoning is required, a 5% upcharge will be added to each product. Please contact client services for additional information.

CIELO® OCCASIONAL TABLES | Designed by Chris Panichella



SPECIFICATIONS:

- Round, square and rectangular top shapes.
- Pull-up table also available.
- Laminate, solid surface and glass top surfaces.
- Laminate tops feature an exposed wood edge with clear-coat finish.
- Solid surface available in white only.
- Glass tops are back-painted white as standard and may be used as a writable surface with dry-erase markers.
- Back-painted glass and solid surface tops feature wood substrate.
- Laminate available in all standard colors. Please refer to standard finish card.
- For custom laminate options, add \$550 List per color per order. Pre-approval required, please contact client services.
- Laminate tops are 3/4" thick, solid surface tops are 1/2" thick and back-painted glass tops are 1/4" thick.
- Metal base available in standard and premium finishes. See below for options.
- For custom metal finish colors, please contact client services for pricing.
- All dimensions are nominal.
- Refer to terms and conditions for general information regarding finishes, warranty, freight, complete condition of sales and more.

STANDARD METAL BASE FINISH COLORS:

- #06 Charcoal Grey
- #90 Metallic Silver
- #91 Chrome
- #95 Satin Black

PREMIUM METAL BASE FINISH COLORS:

- #07 Gold Shimmer
- #08 Penny
- #09 Brown Sugar
- #83 Metallic Champagne
- #94 Cotton

All shipments for this series will be blanket-wrapped as standard. If cartoning is required, a 5% upcharge will be added to each product. Please contact client services for additional information.



CIELO® OCCASIONAL TABLES | Designed by Chris Panichella



Laminate and glass tops with #90 Metallic Silver and #91 Chrome base finishes only

ORDERING REQUIREMENTS:

- Model number
- Table top finish
- Base finish
- Options, as applicable

	MODEL	DIMENSIONS	LAMINATE TOP (-L)	SOLID SURFACE TOP (-SF)	BACK-PAINTED GLASS TOP (-GL)	WEIGHT
	Round Table					
	8060-1818-()	18" Dia. x 18" H	927	1,051	959	11
	8060-2218-()	22" Dia. x 18" H	980	1,200	1,062	13
	8060-3016-()	30" Dia. x 16" H	1,304	1,648	1,400	23
	8060-3616-()	36" Dia. x 16" H	1,426	2,101	1,555	30
	Square Table					
	8065-181818-()	18" W x 18" D x 18" H	894	1,018	959	13
	8065-222218-()	22" W x 22" D x 18" H	922	1,142	1,005	15
	8065-303016-()	30" W x 30" D x 16" H	1,248	1,592	1,344	25
	8065-363616-()	36" W x 36" D x 16" H	1,392	2,067	1,521	32
	Rectangular Table					
	8065-432016-()	43" W x 20" D x 16" H	1,359	1,959	1,467	25

OPTIONS

- PF02 Premium Metal Frame Finish \$80
- NS04 Non-Skid Glides \$42

Note: Round solid surface and glass tops may vary slightly in size from the dimensions listed above. Please contact client services if exact dimensions are required.

All shipments for this series will be blanket-wrapped as standard. If cartoning is required, a 5% upcharge will be added to each product. Please contact client services for additional information.

CIELO® PULL-UP TABLE | Designed by Chris Panichella



Laminate and glass tops with #90 Metallic Silver and #91 Chrome base finishes only

ORDERING REQUIREMENTS:

- Model number
- Table top finish
- Base finish
- Options, as applicable

MODEL	DESCRIPTION	LAMINATE TOP (-L)	SOLID SURFACE TOP (-SF)	BACK-PAINTED GLASS TOP (-GL)	WEIGHT
8055-() 	Free-Standing Pull-Up Table 18" W x 14" D x 26.5" H	806	910	864	16

OPTIONS

-PF02 Premium Metal Frame Finish \$80

CLIPSE LOUNGE | Designed by 5d Studio



SPECIFICATIONS:

- Lounge, love seat and sofa models available with wood legs or platform base with metal legs.
- Wood legs available in all standard finishes on Ash. Please refer to standard finish card.
- For custom wood finishes, please add \$450 List per color per order.
- Platform base with metal legs available in standard and premium finishes. See following page for options.
- For custom metal finish colors, please contact client services for pricing.
- VCT tile glides available for hard surface floors. Please specify "-VCT02B" after model number and add \$24 List per unit.
- Swivel base and mobile lounge chairs also offered.
- Swivel base features 360-degree turning radius with self-return.
- Standard and premium base finishes also offered on swivel base and mobile lounge models.
- Mobile lounge chairs feature two locking casters in rear and two non-locking casters in front. Casters available in silver finish only.
- Casters feature semi-soft treads for compatibility on all floor surfaces.
- Optional accessories sold separately.
- 300 lb. weight capacity.
- All dimensions are nominal.
- Refer to terms and conditions for general information regarding fabrics, finishes, warranty, freight, complete condition of sales and more.

ROTATING TABLET:

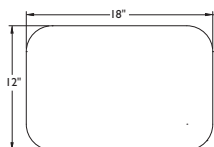

- Tablet affixed to right or left arm, as specified.
- Tablet size is 18" W x 12" D x .75" thick and features 360-degree turning radius.
- Two tablet surface options: laminate and solid surface.
- Solid surface available in white only.
- For standard laminate finishes, refer to standard finish card.
- For custom laminate options, add \$550 List per color per order. Pre-approval required, please contact client services.
- Exposed wood edge with clear-coat finish standard.
- Tablet mounting bracket features #90 Metallic Silver finish as standard. #95 Satin Black finish also available. Please specify.
- 100 lb. weight capacity.

CLIPSE LOUNGE | Designed by 5d Studio

POWER UNITS:

- Available on fixed leg models only (not available on swivel base and mobile versions).
- Dimensions: 5.25" W x 4.25" L
- Touch-latch lid provides easy access to data and electrical features.
- 72" electrical cord.
- Unit will be positioned on right side, as seated, unless otherwise specified.
- If specified in conjunction with a tablet, power unit will be mounted to same side as tablet, unless otherwise specified.
- UL listed.

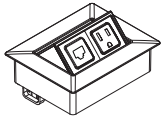

Portal Power 1 (PP1):

- One outlet and one RJ-45 jack (Cat 6) with 72" patch cable.
- Satin nickel finish.

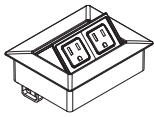

Portal Power 2 (PP2):

- Two outlets.
- Satin nickel finish.

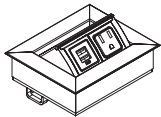

Portal Power 3 (PP3):

- One outlet and two USB charging ports.
- Clear anodized aluminum finish.

STANDARD METAL BASE FINISH COLORS:

- #06 Charcoal Grey
- #90 Metallic Silver
- #91 Chrome (metal leg base only)
- #93 Polished Stainless Steel (swivel base only)
- #95 Satin Black

PREMIUM METAL BASE FINISH COLORS:

- #07 Gold Shimmer
- #08 Penny
- #09 Brown Sugar
- #83 Metallic Champagne
- #94 Cotton

All shipments for this series will be blanket-wrapped as standard. If cartoning is required, a 5% upcharge will be added to each product. Please contact client services for additional information.





CLIPSE LOUNGE | Designed by 5d Studio



Metal Leg and swivel base models with #90 Metallic Silver and #91 Chrome/#93 Polished Stainless Steel base finishes only

ORDERING REQUIREMENTS:

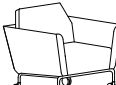
- Model number
- Base finish
- Upholstery selection
- Options, as applicable

MODEL	PRODUCT SPECIFICATIONS	FABRIC GRADES										LEATHER	
		COM	A	1	2	3	4	COL 5	6	7	8	L1	L2
6270 	Lounge Chair, Metal Legs 32" W x 29" D x 29.5" H Seat: 24" W x 20" D Seat Ht: 17.5" COM: 4 yds. COL: 80 sq. ft. 55 lbs.	1,345	1,505	1,617	1,681	1,793	1,909	2,017	2,129	2,233	2,349	2,869	3,249
6270-W 	Lounge Chair, Wood Legs 32" W x 29" D x 29.5" H Seat: 24" W x 20" D Seat Ht: 17.5" COM: 4 yds. COL: 80 sq. ft. 55 lbs.	1,490	1,650	1,762	1,826	1,938	2,054	2,162	2,274	2,378	2,494	3,014	3,394
6275 	Lounge Chair, Casters 32" W x 29" D x 29.5" H Seat: 24" W x 20" D Seat Ht: 17.5" COM: 4 yds. COL: 80 sq. ft. 55 lbs.	1,447	1,607	1,719	1,783	1,895	2,011	2,119	2,231	2,335	2,451	2,971	3,351
6276 	Lounge Chair, Swivel Base 32" W x 29" D x 29.5" H Seat: 24" W x 20" D Seat Ht: 17.5" COM: 4 yds. COL: 80 sq. ft. 72 lbs.	1,688	1,848	1,960	2,024	2,136	2,252	2,360	2,472	2,576	2,692	3,212	3,592

OPTIONS





-PF02	Premium Metal Base Finish, Fixed Metal Leg Models	\$80	-PP1	Portal Power 1 (1 power, 1 data)	\$635
-PF04	Premium Metal Base Finish, Swivel Base Models	\$135	-PP2	Portal Power 2 (dual power)	\$520
-TAR01-L	Laminate Rotating Tablet, Right (as seated)	\$450	-PP3	Portal Power 3 (1 power, 2 USB)	\$755
-TAL01-L	Laminate Rotating Tablet, Left (as seated)		-NS04	Non-Skid Glides (wood leg models only)	\$42
-TAR01-SF	Solid Surface Rotating Tablet, Right (as seated)	\$540	-VCT04	VCT Tile Glides (fixed metal leg models only)	\$24
-TAL01-SF	Solid Surface Rotating Tablet, Left (as seated)				

All shipments for this series will be blanket-wrapped as standard. If cartoning is required, a 5% upcharge will be added to each product. Please contact client services for additional information.

CLIPSE LOUNGE | Designed by 5d Studio

ORDERING REQUIREMENTS:

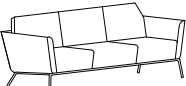
- Model number
- Base finish
- Upholstery selection
- Options, as applicable

MODEL	PRODUCT SPECIFICATIONS	FABRIC GRADES											
		COM	A	1	2	3	4	COL 5	6	7	8	L1	L2
6280 	Love Seat, Metal Legs 58" W x 29" D x 29.5" H Seat: 49" W x 20" D Seat Ht: 17.5" COM: 5.5 yds. COL: 110 sq. ft. 85 lbs.	2,001	2,221	2,375	2,463	2,617	2,777	2,925	3,079	3,222	3,382	4,097	4,619
6280-W 	Love Seat, Wood Legs 58" W x 29" D x 29.5" H Seat: 49" W x 20" D Seat Ht: 17.5" COM: 5.5 yds. COL: 110 sq. ft. 85 lbs.	2,246	2,466	2,620	2,708	2,862	3,022	3,170	3,324	3,467	3,627	4,342	4,864
6290 	Sofa, Metal Legs 81.5" W x 29" D x 29.5" H Seat: 73" W x 20" D Seat Ht: 17.5" COM: 7.25 yds. COL: 145 sq. ft. 130 lbs.	2,788	3,078	3,281	3,397	3,600	3,811	4,006	4,209	4,398	4,608	5,551	6,239
6290-W 	Sofa, Wood Legs 81.5" W x 29" D x 29.5" H Seat: 73" W x 20" D Seat Ht: 17.5" COM: 7.25 yds. COL: 145 sq. ft. 130 lbs.	3,074	3,364	3,567	3,683	3,886	4,097	4,292	4,495	4,684	4,894	5,837	6,525

OPTIONS

-PF02	Premium Metal Base Finish	\$80	-PP1	Portal Power 1 (1 power, 1 data)	\$635
-TAR01-L	Laminate Rotating Tablet, Right (as seated)	\$450	-PP2	Portal Power 2 (dual power)	\$520
-TAL01-L	Laminate Rotating Tablet, Left (as seated)		-PP3	Portal Power 3 (1 power, 2 USB)	\$755
-TAR01-SF	Solid Surface Rotating Tablet, Right (as seated)	\$540	-NS04	Non-Skid Glides (wood leg models only)	\$42
-TAL01-SF	Solid Surface Rotating Tablet, Left (as seated)		-VCT04	VCT Tile Glides (fixed metal leg models only)	\$24

CLIPSE LOUNGE | Designed by 5d Studio

UPHOLSTERY COMBINATIONS:

- For upholstery combinations, refer to the pricing below.
- When combining two COM/COV/COL fabrics, or fabrics with the same grade, add \$85 List per unit.
- When combining three or more COM/COV/COL fabrics, or fabrics with the same grade, add \$115 List per unit.
- When combining different grades of fabric, price will be based on the highest grade specified.
- Two-tine upholstery examples and yardage requirements for the most common combinations are listed below. Additional combinations available; please contact client services for yardage requirements and pricing.
- Note: Yardage amounts are based on fabric which is plain (i.e. non-directional) and a full 54" wide.
- Appropriate upholstery code must be included.

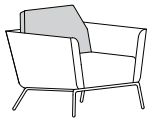

Code **CL1**
Model COM Requirement
 6270 Back Cushion Only = 1.25 yds.
 6270-W Balance of Chair = 3.5 yds.
 6275
 6276

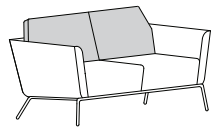

Code **CL2**
Model COM Requirement
 6280 Back Cushion Only = 1.75 yds.
 6280-W Balance of Love Seat = 4.25 yds.

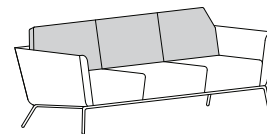

Code **CL3**
Model COM Requirement
 6290 Back Cushion Only = 2.25 yds.
 6290-W Balance of Sofa = 5.5 yds.

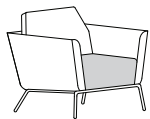

Code **CL4**
Model COM Requirement
 6270 Seat Cushion Only = 1.25 yds.
 6270-W Balance of Chair = 3 yds.
 6275
 6276

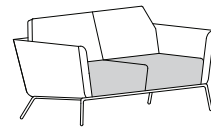

Code **CL5**
Model COM Requirement
 6280 Seat Cushion Only = 1.75 yds.
 6280-W Balance of Love Seat = 4 yds.

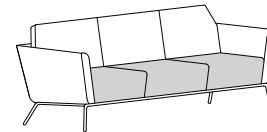

Code **CL6**
Model COM Requirement
 6290 Seat Cushion Only = 2.5 yds.
 6290-W Balance of Sofa = 5 yds.

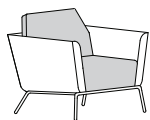

Code **CL7**
Model COM Requirement
 6270 Back & Seat Cushion = 2 yds.
 6270-W Balance of Chair = 2.75 yds.
 6275
 6276

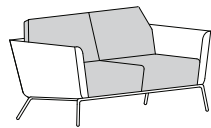

Code **CL8**
Model COM Requirement
 6280 Back & Seat Cushion = 3.25 yds.
 6280-W Balance of Love Seat = 2.5 yds.

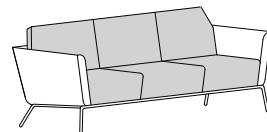

Code **CL9**
Model COM Requirement
 6290 Back & Seat Cushion = 4.5 yds.
 6290-W Balance of Sofa = 3.25 yds.

CREST LOUNGE | Designed by Qdesign



SPECIFICATIONS:

- Mid- and high back lounge chairs with rocker base.
- Upholstered and black urethane arm cap options.
- Upholstered arm cap fabric will match balance of upholstery as standard.
- Accompanying footrest also available.
- 2" wide x .25" thick steel frame.
- Frame available in standard and premium finishes. See below for options.
- For custom finish colors, please contact client services for pricing.
- 350 lb. weight capacity.
- All dimensions are nominal.
- Refer to terms and conditions for general information regarding fabrics, finishes, warranty, freight, complete condition of sales and more.

STANDARD METAL FRAME FINISH COLORS:

- #06 Charcoal Grey
- #90 Metallic Silver
- #95 Satin Black

PREMIUM METAL FRAME FINISH COLORS:





- #07 Gold Shimmer
- #08 Penny
- #09 Brown Sugar
- #83 Metallic Champagne
- #94 Cotton

All shipments for this series will be blanket-wrapped as standard. If cartoning is required, a 5% upcharge will be added to each product. Please contact client services for additional information.

CREST LOUNGE | Designed by Qdesign

ORDERING REQUIREMENTS:

- Model number
- Frame finish
- Upholstery selection
- Options, as applicable

MODEL	PRODUCT SPECIFICATIONS	FABRIC GRADES										LEATHER	
		COM	A	1	2	3	4	COL 5	6	7	8	L1	L2
16222-M-AU 	Mid-Back, Upholstered Arm Caps 28.25" W x 29" D x 33.5" H Seat: 22.5" W x 18.5" D Seat Ht: 16.75" Arm Ht: 23.5" COM: 1.75 yds. COL: 35 sq. ft. 46 lbs.	1,032	1,102	1,151	1,179	1,228	1,279	1,326	1,375	1,421	1,472	1,699	1,865
16222-M-AB 	Mid-Back, Black Urethane Arm Caps 28.25" W x 29" D x 33.5" H Seat: 22.5" W x 18.5" D Seat Ht: 16.75" Arm Ht: 23.5" COM: 1.75 yds. COL: 35 sq. ft. 46 lbs.	1,032	1,102	1,151	1,179	1,228	1,279	1,326	1,375	1,421	1,472	1,699	1,865
16222-H-AU 	High Back, Upholstered Arm Caps 28.25" W x 29" D x 42" H Seat: 22.5" W x 18.5" D Seat Ht: 16.75" Arm Ht: 23.5" COM: 2 yds. COL: 40 sq. ft. 50 lbs.	1,125	1,205	1,261	1,293	1,349	1,407	1,461	1,517	1,569	1,627	1,887	2,077
16222-H-AB 	High Back, Black Urethane Arm Caps 28.25" W x 29" D x 42" H Seat: 22.5" W x 18.5" D Seat Ht: 16.75" Arm Ht: 23.5" COM: 2 yds. COL: 40 sq. ft. 50 lbs.	1,125	1,205	1,261	1,293	1,349	1,407	1,461	1,517	1,569	1,627	1,887	2,077
16512 	Footrest 22" W x 17" D x 13.25" H COM: .5 yd. COL: 10 sq. ft. 24 lbs.	639	659	673	681	695	710	723	737	750	765	830	877

OPTIONS

- PF02 Premium Metal Frame Finish \$80
- MB01 Moisture Barrier \$52

CREST LOUNGE | Designed by Qdesign

UPHOLSTERY COMBINATIONS:

- For upholstery combinations, refer to the pricing below.
- When combining two COM/COV/COL fabrics, or fabrics with the same grade, add \$85 List per unit.
- When combining three or more COM/COV/COL fabrics, or fabrics with the same grade, add \$115 List per unit.
- When combining different grades of fabric, price will be based on the highest grade specified.
- Two-tine upholstery examples and yardage requirements for the most common combinations are listed below. Additional combinations available; please contact Client Services for yardage requirements and pricing.
- Note: Yardage amounts are based on fabric which is plain (i.e. non-directional) and a full 54" wide.
- Appropriate upholstery code must be included.

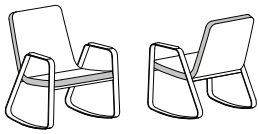

Code CR1
Model COM Requirement
 16222-M-AU Side/Front Panels = 1 yd.
 16222-M-AB Balance of Chair = 1.75 yds.

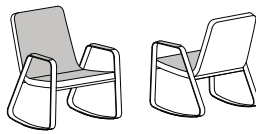

Code CR2
Model COM Requirement
 16222-M-AU Seat Front/Back Front/Arm Caps = .75 yd.
 16222-M-AB Balance of Chair = 1 yd.

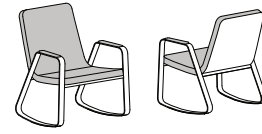

Code CR3
Model COM Requirement
 16222-M-AU Seat Front/Back Front/
 16222-M-AB Side & Front Panels/Arm Caps = 1 yd.
 Balance of Chair = .75 yd.

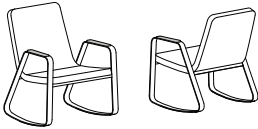

Code CR4
Model COM Requirement
 16222-M-AU Arm Caps = .25 yd.
 Balance of Chair = 1.5 yds.

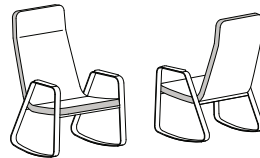

Code CR5
Model COM Requirement
 16222-H-AU Side/Front Panels = 1 yd.
 16222-H-AB Balance of Chair = 2 yds.

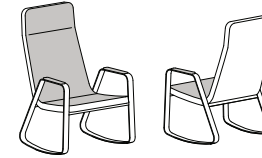

Code CR6
Model COM Requirement
 16222-H-AU Seat Front/Back Front/Arm Caps = 1 yd.
 16222-H-AB Balance of Chair = 1.25 yds.

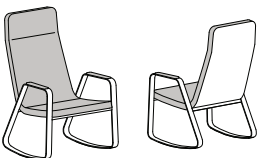

Code CR7
Model COM Requirement
 16222-H-AU Seat Front/Back Front/
 16222-H-AB Side & Front Panels/
 Arm Caps = 1 yd.
 Balance of Chair = 1 yd.

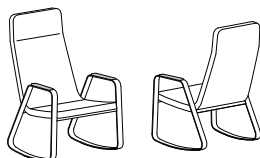

Code CR8
Model COM Requirement
 16222-H-AU Arm Caps = .25 yd.
 16222-H-AB Balance of Chair = 1.75 yds.



Code CF1
Model COM Requirement
 16512 Side Panels = .5 yd.
 Balance of Footrest = .5 yd.

All shipments for this series will be cartoned as standard. If blanket-wrapped shipping is required, please contact client services for additional information.

DABBLE MODULAR | Designed by David Dahl



PRODUCT FEATURES:

- Benches and tables available as stand-alone units or in modular configurations.
- Metal legs offered in standard and premium finishes. See following pages for options.
- Models with ganging legs are field assembled.
- All dimensions are nominal.
- Refer to terms and conditions for general information regarding fabrics, finishes, warranty, freight, complete condition of sales and more.

BENCHES:

- Straight and 45-degree models.
- Stand-alone 45-degree models feature 5 legs to ensure stability.
- 300 lb. weight capacity.
- Optional power units available for placement on front panel of straight models only (not available on 45-degree models).

TABLES:

- Wood veneer, laminate and solid surface top surface options with fully upholstered side panels.
- Table tops feature self edge as standard.
- Beech, White Oak and Walnut wood species available in all standard finishes. Please refer to standard finish card.
- For custom wood finishes, please add \$450 List per color per order.
- Laminate offered in all standard colors. For custom laminate options, add \$550 List per color per order. Pre-approval required, please contact client services.
- Solid surface available in white only. To order a non-standard solid surface color, please specify the manufacturer, pattern name and color number. Contact client services to confirm pricing.

STATIONARY TABLE-ETTE:

- Stationary table-ette available on table units and measures 10" dia. x 3/4" thick.
- Three table-ette surface options: wood veneer, laminate and solid surface.
- Beech, White Oak and Walnut wood species available in all standard finishes. Please refer to standard finish card.
- For custom wood finishes, please add \$450 List per color per order.
- Laminate offered in all standard colors. For custom laminate options, add \$550 List per color per order. Pre-approval required, please contact client services.
- Solid surface available in white only. To order a non-standard solid surface color, please specify the manufacturer, pattern name and color number. Contact client services to confirm pricing.
- Tops feature an exposed wood edge with clear-coat finish as standard.
- Table-ette mounting post will match leg finish unless specified otherwise.

All shipments for this series will be cartoned as standard. If blanket-wrapped shipping is required, please contact client services for additional information.

DABBLE MODULAR | Designed by David Dahl

STANDARD METAL BASE FINISH COLORS:

- #06 Charcoal Grey
- #90 Metallic Silver
- #91 Chrome (metal leg base only)
- #93 Polished Stainless Steel (swivel base only)
- #95 Satin Black

PREMIUM METAL BASE FINISH COLORS:

- #07 Gold Shimmer
- #08 Penny
- #09 Brown Sugar
- #83 Metallic Champagne
- #94 Cotton

POWER BAND UNITS:

- Available on all tables and straight benches (not available on 45-degree models).
- Dimensions: 5.75" L x 2.5" W
- Metallic silver and white finish options.
- 108" electrical cord.
- Tables: placement may be specified on table top, front panel or end panel.
- Benches: placement available on front panel only.
- Please note that when table-ettes are specified on tables, table top placement for power units is not available.
- UL listed.

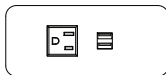

Power Band 1 (PB1):

- One outlet and two USB charging ports.

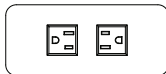

Power Band 2 (PB2):

- Two outlets.

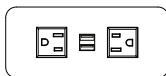

Power Band 3 (PB3):

- One outlet and two USB charging ports.
- Two outlets and two USB charging ports.

PORTAL POWER UNITS:

- Placement may be specified on table top, front panel or end panel.
- Please note that when table-ettes are specified, table top placement for power units is not available.
- Dimensions: 5.25" W x 4.25" L
- Touch-latch lid provides easy access to data and electrical features.
- 72" electrical cord.
- Unit will be positioned on right side, as seated, unless otherwise specified.
- If specified in conjunction with a tablet, power unit will be mounted to same side as tablet, unless otherwise specified.
- UL listed.

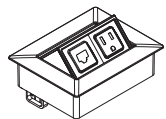

Portal Power 1 (PP1):

- One outlet and one RJ-45 jack (Cat 6) with 72" patch cable.
- Satin nickel finish.

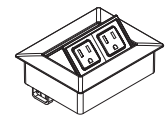

Portal Power 2 (PP2):

- Two outlets.
- Satin nickel finish.

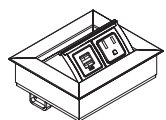

Portal Power 3 (PP3):

- One outlet and two USB charging ports.
- Clear anodized aluminum finish.

All shipments for this series will be cartoned as standard. If blanket-wrapped shipping is required, please contact client services for additional information.

DABBLE MODULAR | Designed by David Dahl

FABRIC APPLICATION:

- Fabric is cut "up the roll" as a standard cutting procedure (see example below). If another direction is required (i.e. "railroaded"), please specify and contact client services for yardage requirements.

Up the Roll

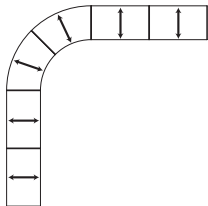

Railroaded

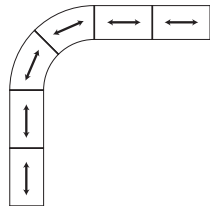

MODULAR ARRANGEMENTS:

- Ganging leg connects two units together and reduces overall quantity of legs.
- Refer to individual pages for specification information and pricing.
- Field assembly required.

Straight Benches:

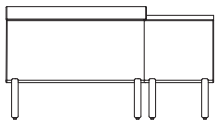

Standard Leg - Front View

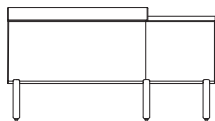

Ganging Leg - Front View

45-Degree Benches:

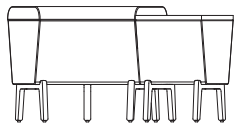

Standard Leg - Front View

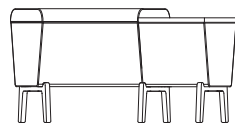

Ganging Leg - Front View

Note: Layout drawings or sketch is required with each modular order.

All shipments for this series will be cartoned as standard. If blanket-wrapped shipping is required, please contact client services for additional information.

DABBLE MODULAR | Designed by David Dahl

ORDERING REQUIREMENTS:

- Model number
- Base finish
- Upholstery selection
- Options, as applicable

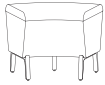
MODEL	PRODUCT SPECIFICATIONS	FABRIC GRADES								LEATHER			
		COM	A	1	2	3	4	COL 5	6	7	8	L1	L2
1724 	Straight Bench Overall: 24" W x 14.5" D x 19.5" H" COM: 1.25 yds. COL: 25 sq. ft. 21 lbs.	819	869	904	924	959	996	1,029	1,064	1,097	1,133	1,296	1,414
1745 	45-Degree Bench Overall: 27.5" W x 14.5" D x 19.5" H" COM: 1.25 yds. COL: 25 sq. ft. 22 lbs.	905	955	990	1,010	1,045	1,082	1,115	1,150	1,183	1,219	1,382	1,500

OPTIONS

-PF02	Premium Metal Leg Finish	\$80
-MB01	Moisture Barrier	\$52
-NS04	Non-Skid Glides	\$42
-PB1-S	Power Band 1 (1 power, 2 USB), Silver	\$430
-PB1-W	Power Band 1 (1 power, 2 USB), White	\$430
-PB2-S	Power Band 2 (dual power), Silver	\$340
-PB2-W	Power Band 2 (dual power), White	\$340
-PB3-S	Power Band 3 (2 power, 2 USB), Silver	\$450
-PB3-W	Power Band 3 (2 power, 2 USB), White	\$450



Please note that power units are only available on straight benches (not available on 45-degree models).

All shipments for this series will be cartoned as standard. If blanket-wrapped shipping is required, please contact client services for additional information.

DABBLE MODULAR | Designed by David Dahl

ORDERING REQUIREMENTS:

- Model number
- Table top finish
- Base finish
- Upholstery selection
- Options, as applicable

MODEL	PRODUCT SPECIFICATIONS	FABRIC GRADES										LEATHER	
		COM	A	1	2	3	4	COL 5	6	7	8	L1	L2
1712-W 	Table, Wood Top Overall: 12" W x 14" D x 17.75 H" COM: 1 yd. COL: 20 sq. ft. 14 lbs.	701	741	769	785	813	842	869	897	923	952	1,082	1,177
1712-L 	Table, Laminate Top Overall: 12" W x 14" D x 17.75 H" COM: 1 yd. COL: 20 sq. ft. 14 lbs.	701	741	769	785	813	842	869	897	923	952	1,082	1,177
1712-SF 	Table, Solid Surface Top Overall: 12" W x 14" D x 17.75 H" COM: 1 yd. COL: 20 sq. ft. 14 lbs.	770	810	838	854	882	911	938	966	992	1,021	1,151	1,246

OPTIONS

-PF02	Premium Metal Leg Finish	\$80	-PB1-S	Power Band 1 (1 power, 2 USB), Silver	\$430
-NS04	Non-Skid Glides	\$42	-PB1-W	Power Band 1 (1 power, 2 USB), White	\$430
-STC01-W	Stationary Table-ette, Wood Top	\$284	-PB2-S	Power Band 2 (dual power), Silver	\$340
-STC01-L	Stationary Table-ette, Laminate Top	\$284	-PB2-W	Power Band 2 (dual power), White	\$340
-STC01-SF	Stationary Table-ette, Solid Surface Top	\$341	-PB3-S	Power Band 3 (2 power, 2 USB), Silver	\$450
			-PB3-W	Power Band 3 (2 power, 2 USB), White	\$450
			-PP1	Portal Power 1 (1 power, 1 data)	\$635
			-PP2	Portal Power 2 (dual power)	\$520
			-PP3	Portal Power 1 (1 power, 2 USB)	\$755



Please note that when table-ettes are specified, power unit placement must be on front panel or end panel (table top placement not available).

All shipments for this series will be cartoned as standard. If blanket-wrapped shipping is required, please contact client services for additional information.

DABBLE MODULAR | Designed by David Dahl

PRODUCT FEATURES:

- Modular benches are connected together using shared legs.
- Legs are ordered separately from seating units and must be assembled in the field.
- Please refer to page 59 for leg options and pricing.
- Accompanying modular tables also offered. Please refer to page 58.
- Please include layout drawings or sketch with each order.

MODEL	PRODUCT SPECIFICATIONS	FABRIC GRADES								LEATHER			
		COM	A	1	2	3	4	COL 5	6	7	8	L1	L2
1724-G 	Straight Modular Bench Overall: 24" W x 14.5" D x 19.5 H" COM: 1.25 yds. COL: 25 sq. ft. 19 lbs.	660	710	745	765	800	837	870	905	938	974	1,137	1,255
1745-G 	45-Degree Modular Bench Overall: 27.5" W x 14.5" D x 19.5" H COM: 1.25 yds. COL: 25 sq. ft. 20 lbs. Legs: page 59 Tables: page 58	710	760	795	815	850	887	920	955	988	1,024	1,187	1,305

OPTIONS

-MB01	Moisture Barrier	\$52
-PB1-S	Power Band 1 (1 power, 2 USB), Silver	\$430
-PB1-W	Power Band 1 (1 power, 2 USB), White	\$430
-PB2-S	Power Band 2 (dual power), Silver	\$340
-PB2-W	Power Band 2 (dual power), White	\$340
-PB3-S	Power Band 3 (2 power, 2 USB), Silver	\$450
-PB3-W	Power Band 3 (2 power, 2 USB), White	\$450



Please note that power units are only available on straight benches (not available on 45-degree models).

All shipments for this series will be cartoned as standard. If blanket-wrapped shipping is required, please contact client services for additional information.

DABBLE MODULAR | Designed by David Dahl

PRODUCT FEATURES:

- Modular tables are connected together using shared legs.
- Legs are ordered separately from seating units and must be assembled in the field.
- Please refer to page 59 for leg options and pricing.
- Accompanying modular benches also offered. Please refer to page 57.
- Please include layout drawings or sketch with each order.

MODEL	PRODUCT SPECIFICATIONS	FABRIC GRADES								LEATHER			
		COM	A	1	2	3	4	COL 5	6	7	8	L1	L2
1712-G-W 	Modular Table, Wood Top Overall: 12" W x 14" D x 17.75 H" COM: 1 yd. COL: 20 sq. ft. 12 lbs.	541	581	609	625	653	682	709	737	763	792	922	1,017
1712-G-L 	Modular Table, Laminate Top Overall: 12" W x 14" D x 17.75 H" COM: 1 yd. COL: 20 sq. ft. 12 lbs.	541	581	609	625	653	682	709	737	763	792	922	1,017
1712-G-SF 	Modular Table, Solid Surface Top Overall: 12" W x 14" D x 17.75 H" COM: 1 yd. COL: 20 sq. ft. 12 lbs. Legs: page 59 Benches: page 57	610	650	678	694	722	751	778	806	832	861	991	1,086

OPTIONS

-STC01-W	Stationary Table-ette, Wood Top	\$284	-PP1	Portal Power 1 (1 power, 1 data)	\$635
-STC01-L	Stationary Table-ette, Laminate Top	\$284	-PP2	Portal Power 2 (dual power)	\$520
-STC01-SF	Stationary Table-ette, Solid Surface Top	\$341	-PP3	Portal Power 1 (1 power, 2 USB)	\$755
-PB1-S	Power Band 1 (1 power, 2 USB), Silver	\$430			
-PB1-W	Power Band 1 (1 power, 2 USB), White	\$430			
-PB2-S	Power Band 2 (dual power), Silver	\$340			
-PB2-W	Power Band 2 (dual power), White	\$340			
-PB3-S	Power Band 3 (2 power, 2 USB), Silver	\$450			
-PB3-W	Power Band 3 (2 power, 2 USB), White	\$450			



Please note that when table-ettes are specified, power unit placement must be on front panel or end panel (table top placement not available).

All shipments for this series will be cartoned as standard. If blanket-wrapped shipping is required, please contact client services for additional information.

DABBLE MODULAR | Designed by David Dahl

PRODUCT FEATURES:

- Connecting legs for modular configurations.
- Legs are specified separately from benches and tables and must be field-installed.
- Please refer to pages 57-58 for accompanying benches and tables.
- End legs are for placement at the beginning or end of a configuration.
- Ganging legs connect two units together.
- Please include layout drawings or sketch with each order.

MODEL	DESCRIPTION	LIST
1780 	End Legs 2 lbs.	78
1781 	Ganging Legs 4 lbs.	103

OPTIONS

- | | | |
|-------|--------------------------|------|
| -PF02 | Premium Metal Leg Finish | \$80 |
| -NS02 | Non-Skid Glides | \$22 |

All shipments for this series will be cartoned as standard. If blanket-wrapped shipping is required, please contact client services for additional information.

DABBLE MODULAR | Designed by David Dahl

UPHOLSTERY COMBINATIONS:

- For upholstery combinations, refer to the pricing below.
- When combining two COM/COV/COL fabrics, or fabrics with the same grade, add \$85 List per unit.
- When combining three or more COM/COV/COL fabrics, or fabrics with the same grade, add \$115 List per unit.
- When combining different grades of fabric, price will be based on the highest grade specified.
- Two-tine upholstery examples and yardage requirements for the most common combinations are listed below. Additional combinations available; please contact client services for yardage requirements and pricing.
- Note: Yardage amounts are based on fabric which is plain (i.e. non-directional) and a full 54" wide.
- Appropriate upholstery code must be included.

Code DB1

Model COM Requirement

1724 Seat Cushion Only = .75 yd.

1724-G Balance of Upholstery = 1 yd.

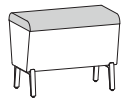

Code DB2

Model COM Requirement

1745 Seat Cushion Only = .75 yd.

1745-G Balance of Upholstery = 1 yd.

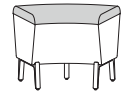

All shipments for this series will be cartoned as standard. If blanket-wrapped shipping is required, please contact client services for additional information.

DABBLE MODULAR - CONFIGURATION & ORDERING EXAMPLES

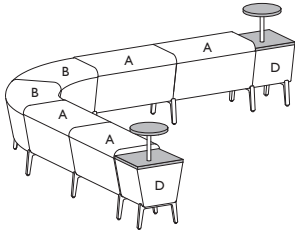

Qty	Model #	Description	COM List	Key
4	1724-G	Straight Modular Bench (\$660 List each)	\$2,640	A
2	1745-G	45-Degree Modular Bench (\$710 List each)	\$1,420	B
2	1712-G-W-STC01-W	Modular Table with Table-ette, Wood Top (\$825 List each)	\$1,650	D
2	1780	End Legs (\$78 List each)	\$156	
7	1781	Ganging Legs (\$103 List each)	<u>\$721</u>	
			\$6,587	

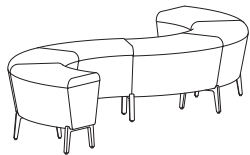

Qty	Model #	Description	COM List	Key
6	1745-G	45-Degree Modular Bench (\$710 List each)	\$4,260	n/a
2	1780	End Legs (\$78 List each)	\$156	
5	1781	Ganging Legs (\$103 List each)	<u>\$515</u>	
			\$4,931	

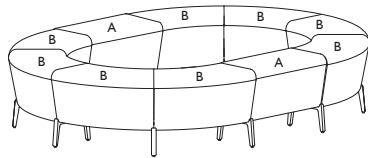

Qty	Model #	Description	COM List	Key
8	1745-G	45-Degree Modular Bench (\$710 List each)	\$5,680	B
2	1724-G	Straight Modular Bench (\$660 List each)	\$1,320	A
10	1781	Ganging Legs (\$103 List each)	<u>\$1,030</u>	
			\$8,030	

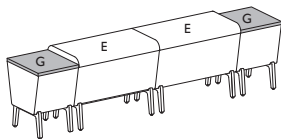

Qty	Model #	Description	COM List	Key
2	1724	Straight Bench (\$819 List each)	\$1,638	E
2	1712-L	Table, Laminate Top (\$701 List each)	<u>\$1,402</u>	G
			\$3,040	

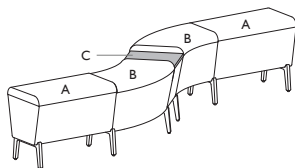

Qty	Model #	Description	COM List	Key
2	1724-G	Straight Modular Bench (\$660 List each)	\$1,320	A
2	1745-G	45-Degree Modular Bench (\$710 List each)	\$1,420	B
1	1712-G-SF	Modular Table, Solid Surface Top	\$610	C
2	1780	End Legs (\$78 List each)	\$156	
4	1781	Ganging Legs (\$103 List each)	<u>\$412</u>	
			\$3,918	

All shipments for this series will be cartoned as standard. If blanket-wrapped shipping is required, please contact client services for additional information.

EDITOR



SPECIFICATIONS:

- Mesh back and fully upholstered models.
- Mesh suspension available in three colors. Please refer to listing below.
- Glass-reinforced black nylon back frame.
- Armless, black adjustable t-arm and black cantilever arm models.
- 3" adjustable t-arm height travel.
- Fixed back height.
- Two base options: black nylon and polished aluminum.
- 300 lb. weight capacity.
- All dimensions are nominal.
- Refer to terms and conditions for general information regarding fabrics, finishes, warranty, freight, complete condition of sales and more.

MESH SUSPENSION COLORS:

- #107 Sterling
- #109 Night
- #126 Wheat



All shipments for this series will be cartoned as standard. If blanket-wrapped shipping is required, please contact client services for additional information.

EDITOR

Weight-Activated Mechanism

ORDERING REQUIREMENTS:

- Model number
- Mesh suspension color
- Base finish
- Upholstery selection
- Options, as applicable

MODEL	PRODUCT SPECIFICATIONS	BASE FINISH	FABRIC GRADES								LEATHER			
			COM	A	1	2	3	4	COL 5	6	7	8	L1	L2
4521-K 	Mesh Back, Armless 20" W x 22.5" D x 39" - 44" H Seat: 19" W x 18.5" D Seat Ht: 17.5" - 22.5" Back: 18" W x 22.5" H COM: 1 yd. COL: 20 sq. ft. 37 lbs.	Black Nylon	867	907	935	951	979	1,008	1,035	1,063	1,089	1,118	1,248	1,343
		Polished Aluminum	946	986	1,014	1,030	1,058	1,087	1,114	1,142	1,168	1,197	1,327	1,422
4523-K 	Mesh Back, Adjustable T-Arms 25.75" W x 22.5" D x 39" - 44" H Seat: 19" W x 18.5" D Seat Ht: 17.5" - 22.5" Back: 18" W x 22.5" H COM: 1 yd. COL: 20 sq. ft. 44 lbs.	Black Nylon	911	951	979	995	1,023	1,052	1,079	1,107	1,133	1,162	1,292	1,387
		Polished Aluminum	990	1,030	1,058	1,074	1,102	1,131	1,158	1,186	1,212	1,241	1,371	1,466
4524-K 	Mesh Back, Cantilever Arms 24.25" W x 22.5" D x 39" - 44" H Seat: 19" W x 18.5" D Seat Ht: 17.5" - 22.5" Back: 18" W x 22.5" H COM: 1 yd. COL: 20 sq. ft. 40 lbs.	Black Nylon	911	951	979	995	1,023	1,052	1,079	1,107	1,133	1,162	1,292	1,387
		Polished Aluminum	990	1,030	1,058	1,074	1,102	1,131	1,158	1,186	1,212	1,241	1,371	1,466

OPTIONS

-SS01	Seat Slider	\$76
-STC02	Soft Tread Casters	\$26
-STLC02	Soft Tread Self-Locking Casters	\$52
-GD04	Glides	\$26
-J01	Jury Base (black only)	\$150



All shipments for this series will be cartoned as standard. If blanket-wrapped shipping is required, please contact client services for additional information.

EDITOR

Synchro-Tilt Mechanism

ORDERING REQUIREMENTS:

- Model number
- Mesh suspension color
- Base finish
- Upholstery selection
- Options, as applicable

MODEL	PRODUCT SPECIFICATIONS	BASE FINISH	FABRIC GRADES								LEATHER			
			COM	A	1	2	3	4	COL 5	6	7	8	L1	L2
4591-K 	Mesh Back, Armless 20" W x 22.5" D x 38" - 43" H Seat: 19" W x 18.5" D Seat Ht: 17" - 22" Back: 18" W x 22.5" H COM: 1 yd. COL: 20 sq. ft. 34 lbs.	Black Nylon	823	863	891	907	935	964	991	1,019	1,045	1,074	1,204	1,299
		Polished Aluminum	902	942	970	986	1,014	1,043	1,070	1,098	1,124	1,153	1,283	1,378
4593-K 	Mesh Back, Adjustable T-Arms 25.75" W x 22.5" D x 38" - 43" H Seat: 19" W x 18.5" D Seat Ht: 17" - 22" Back: 18" W x 22.5" H COM: 1 yd. COL: 20 sq. ft. 41 lbs.	Black Nylon	868	908	936	952	980	1,009	1,036	1,064	1,090	1,119	1,249	1,344
		Polished Aluminum	947	987	1,015	1,031	1,059	1,088	1,115	1,143	1,169	1,198	1,328	1,423
4594-K 	Mesh Back, Cantilever Arms 24.25" W x 22.5" D x 38" - 43" H Seat: 19" W x 18.5" D Seat Ht: 17" - 22" Back: 18" W x 22.5" H COM: 1 yd. COL: 20 sq. ft. 41 lbs.	Black Nylon	868	908	936	952	980	1,009	1,036	1,064	1,090	1,119	1,249	1,344
		Polished Aluminum	947	987	1,015	1,031	1,059	1,088	1,115	1,143	1,169	1,198	1,328	1,423

OPTIONS

-SS02	Seat Slider	\$76
-STC02	Soft Tread Casters	\$26
-STLC02	Soft Tread Self-Locking Casters	\$52
-GD04	Glides	\$26
-J01	Jury Base (black only)	\$150



All shipments for this series will be cartoned as standard. If blanket-wrapped shipping is required, please contact client services for additional information.

EDITOR

Weight-Activated Mechanism

ORDERING REQUIREMENTS:

- Model number
- Base finish
- Upholstery selection
- Options, as applicable

MODEL	PRODUCT SPECIFICATIONS	BASE FINISH	FABRIC GRADES								LEATHER			
			COM	A	1	2	3	4	COL 5	6	7	8	L1	L2
4521-U 	Upholstered Back, Armless 20" W x 22.5" D x 39" - 44" H Seat: 19" W x 18.5" D Seat Ht: 17.5" - 22.5" Back: 18" W x 22.5" H COM: 2 yds. COL: 40 sq. ft. 37 lbs.	Black Nylon	802	882	938	970	1,026	1,084	1,138	1,194	1,246	1,304	1,564	1,754
		Polished Aluminum	881	961	1,017	1,049	1,105	1,163	1,217	1,273	1,325	1,383	1,643	1,833
4523-U 	Upholstered Back, Adjustable T-Arms 25.75" W x 22.5" D x 39" - 44" H Seat: 19" W x 18.5" D Seat Ht: 17.5" - 22.5" Back: 18" W x 22.5" H COM: 2 yds. COL: 40 sq. ft. 44 lbs.	Black Nylon	847	927	983	1,015	1,071	1,129	1,183	1,239	1,291	1,349	1,609	1,799
		Polished Aluminum	926	1,006	1,062	1,094	1,150	1,208	1,262	1,318	1,370	1,428	1,688	1,878
4524-U 	Upholstered Back, Cantilever Arms 24.25" W x 22.5" D x 39" - 44" H Seat: 19" W x 18.5" D Seat Ht: 17.5" - 22.5" Back: 18" W x 22.5" H COM: 2 yds. COL: 40 sq. ft. 40 lbs.	Black Nylon	847	927	983	1,015	1,071	1,129	1,183	1,239	1,291	1,349	1,609	1,799
		Polished Aluminum	926	1,006	1,062	1,094	1,150	1,208	1,262	1,318	1,370	1,428	1,688	1,878

OPTIONS

-SS01	Seat Slider	\$76
-STC02	Soft Tread Casters	\$26
-STLC02	Soft Tread Self-Locking Casters	\$52
-GD04	Glides	\$26
-J01	Jury Base (black only)	\$150



All shipments for this series will be cartoned as standard. If blanket-wrapped shipping is required, please contact client services for additional information.

EDITOR

Synchro-Tilt Mechanism

ORDERING REQUIREMENTS:

- Model number
- Base finish
- Upholstery selection
- Options, as applicable

MODEL	PRODUCT SPECIFICATIONS	BASE FINISH	FABRIC GRADES								LEATHER			
			COM	A	1	2	3	4	COL 5	6	7	8	L1	L2
4591-U 	Upholstered Back, Armless 20" W x 22.5" D x 38" - 43" H Seat: 19" W x 18.5" D Seat Ht: 17" - 22" Back: 18" W x 22.5" H COM: 2 yds. COL: 40 sq. ft. 34 lbs.	Black Nylon	758	838	894	926	982	1,040	1,094	1,150	1,202	1,260	1,520	1,710
		Polished Aluminum	837	917	973	1,005	1,061	1,119	1,173	1,229	1,281	1,339	1,599	1,789
4593-U 	Upholstered Back, Adjustable T-Arms 25.75" W x 22.5" D x 38" - 43" H Seat: 19" W x 18.5" D Seat Ht: 17" - 22" Back: 18" W x 22.5" H COM: 2 yds. COL: 40 sq. ft. 41 lbs.	Black Nylon	803	883	939	971	1,027	1,085	1,139	1,195	1,247	1,305	1,565	1,755
		Polished Aluminum	882	962	1,018	1,050	1,106	1,164	1,218	1,274	1,326	1,384	1,644	1,834
4594-U 	Upholstered Back, Cantilever Arms 24.25" W x 22.5" D x 38" - 43" H Seat: 19" W x 18.5" D Seat Ht: 17" - 22" Back: 18" W x 22.5" H COM: 2 yds. COL: 40 sq. ft. 37 lbs.	Black Nylon	803	883	939	971	1,027	1,085	1,139	1,195	1,247	1,305	1,565	1,755
		Polished Aluminum	882	962	1,018	1,050	1,106	1,164	1,218	1,274	1,326	1,384	1,644	1,834

OPTIONS

-SS02	Seat Slider	\$76
-STC02	Soft Tread Casters	\$26
-STLC02	Soft Tread Self-Locking Casters	\$52
-GD04	Glides	\$26
-J01	Jury Base (black only)	\$150

All shipments for this series will be blanket-wrapped as standard. If cartoning is required, a 5% upcharge will be added to each product. Please contact client services for additional information.

FACTION EXECUTIVE + TASK | Designed by 5d Studio



SPECIFICATIONS:

- Executive and task models.
- Executive models available with polished aluminum cantilever arms or loop arms.
- Task models offered with adjustable t-arms that feature 3" travel.
- Weight-activated and synchro-tilt mechanism options.
- Fixed back height.
- Black nylon base as standard.
- Polished aluminum base also available. Please specify (-ABO2) after model number and refer to listed pricing.
- 300 lb. weight capacity.
- All dimensions are nominal.
- Refer to terms and conditions for general information regarding fabrics, finishes, warranty, freight, complete condition of sales and more.



All shipments for this series will be blanket-wrapped as standard. If cartoning is required, a 5% upcharge will be added to each product. Please contact client services for additional information.

FACTION EXECUTIVE | Designed by 5d Studio

Weight-Activated Synchro-Tilt Mechanism

ORDERING REQUIREMENTS:

- Model number
- Base finish
- Upholstery selection
- Options, as applicable

MODEL	PRODUCT SPECIFICATIONS	BASE FINISH	FABRIC GRADES								LEATHER			
			COM	A	1	2	3	4	COL 5	6	7	8	L1	L2
1812-M 	Mid-Back, Cantilever Arms 23.5" W x 23" D x 38.5" - 42.5" H Seat: 19" W x 18" D Seat Ht: 17.5" - 21.5" Back : 19" W x 21" H COM: 1.75 yds. COL: 35 sq. ft. 45 lbs.	Black Nylon	1,333	1,403	1,452	1,480	1,529	1,580	1,627	1,676	1,722	1,773	2,000	2,166
		Polished Aluminum	1,452	1,522	1,571	1,599	1,648	1,699	1,746	1,795	1,841	1,892	2,119	2,285
1814-M 	Mid-Back, Loop Arms 23" W x 23" D x 38.5" - 42.5" H Seat: 19" W x 18" D Seat Ht: 17.5" - 21.5" Back : 19" W x 21" H COM: 1.75 yds. COL: 35 sq. ft. 46 lbs.	Black Nylon	1,366	1,436	1,485	1,513	1,562	1,613	1,660	1,709	1,755	1,806	2,033	2,199
		Polished Aluminum	1,485	1,555	1,604	1,632	1,681	1,732	1,779	1,828	1,874	1,925	2,152	2,318

OPTIONS

- STC02 Soft Tread Casters \$26
- STLC02 Soft Tread Self-Locking Casters \$52



All shipments for this series will be blanket-wrapped as standard. If cartoning is required, a 5% upcharge will be added to each product. Please contact client services for additional information.

FACTION EXECUTIVE | Designed by 5d Studio

Weight-Activated Synchro-Tilt Mechanism

ORDERING REQUIREMENTS:

- Model number
- Base finish
- Upholstery selection
- Options, as applicable

MODEL	PRODUCT SPECIFICATIONS	BASE FINISH	FABRIC GRADES								LEATHER			
			COM	A	1	2	3	4	COL 5	6	7	8	L1	L2
1812-H 	High Back, Cantilever Arms 23.5" W x 23" D x 49.5" H Seat: 19" W x 18" D Seat Ht: 17.5" - 21.5" Back : 19" W x 28.5" H COM: 2 yds. COL: 40 sq. ft. 48 lbs.	Black Nylon	1,389	1,469	1,525	1,557	1,613	1,671	1,725	1,781	1,833	1,891	2,151	2,341
		Polished Aluminum	1,508	1,588	1,644	1,676	1,732	1,790	1,844	1,900	1,952	2,010	2,270	2,460
1814-H 	High Back, Loop Arms 23" W x 23" D x 45.5" H Seat: 19" W x 18" D Seat Ht: 17.5" - 21.5" Back : 19" W x 28.5" H COM: 2 yds. COL: 40 sq. ft. 49 lbs.	Black Nylon	1,421	1,501	1,557	1,589	1,645	1,703	1,757	1,813	1,865	1,923	2,183	2,373
		Polished Aluminum	1,540	1,620	1,676	1,708	1,764	1,822	1,876	1,932	1,984	2,042	2,302	2,492

OPTIONS

- STC02 Soft Tread Casters \$26
- STLC02 Soft Tread Self-Locking Casters \$52



All shipments for this series will be blanket-wrapped as standard. If cartoning is required, a 5% upcharge will be added to each product. Please contact client services for additional information.

FACTION EXECUTIVE | Designed by 5d Studio

Synchro-Tilt Mechanism

ORDERING REQUIREMENTS:

- Model number
- Base finish
- Upholstery selection
- Options, as applicable

MODEL	PRODUCT SPECIFICATIONS	BASE FINISH	FABRIC GRADES								LEATHER			
			COM	A	1	2	3	4	COL 5	6	7	8	L1	L2
1892-M 	Mid-Back, Cantilever Arms 23.5" W x 23" D x 38.5" - 42.5" H Seat: 19" W x 18" D Seat Ht: 17.5" - 21.5" Back: 19" W x 21" H COM: 1.75 yds. COL: 35 sq. ft. 45 lbs.	Black Nylon	1,206	1,276	1,325	1,353	1,402	1,453	1,500	1,549	1,595	1,646	1,873	2,039
		Polished Aluminum	1,325	1,395	1,444	1,472	1,521	1,572	1,619	1,668	1,714	1,765	1,992	2,158
1894-M 	Mid-Back, Loop Arms 23" W x 23" D x 38.5" - 42.5" H Seat: 19" W x 18" D Seat Ht: 17.5" - 21.5" Back: 19" W x 21" H COM: 1.75 yds. COL: 35 sq. ft. 46 lbs.	Black Nylon	1,238	1,308	1,357	1,385	1,434	1,485	1,532	1,581	1,627	1,678	1,905	2,071
		Polished Aluminum	1,357	1,427	1,476	1,504	1,553	1,604	1,651	1,700	1,746	1,797	2,024	2,190

OPTIONS

-SS02	Seat Slider	\$76
-STC02	Soft Tread Casters	\$26
-STLC02	Soft Tread Self-Locking Casters	\$52



All shipments for this series will be blanket-wrapped as standard. If cartoning is required, a 5% upcharge will be added to each product. Please contact client services for additional information.

FACTION EXECUTIVE | Designed by 5d Studio

Synchro-Tilt Mechanism

ORDERING REQUIREMENTS:

- Model number
- Base finish
- Upholstery selection
- Options, as applicable

MODEL	PRODUCT SPECIFICATIONS	BASE FINISH	FABRIC GRADES								LEATHER			
			COM	A	1	2	3	4	COL 5	6	7	8	L1	L2
1892-H 	High Back, Cantilever Arms 23.5" W x 23" D x 45.5" - 49.5" H Seat: 19" W x 18" D Seat Ht: 17.5" - 21.5" Back: 19" W x 28.5" H COM: 2 yds. COL: 40 sq. ft. 48 lbs.	Black Nylon	1,262	1,342	1,398	1,430	1,486	1,544	1,598	1,654	1,706	1,764	2,024	2,214
		Polished Aluminum	1,381	1,461	1,517	1,549	1,605	1,663	1,717	1,773	1,825	1,883	2,143	2,333
1894-H 	High Back, Loop Arms 23" W x 23" D x 45.5" - 49.5" H Seat: 19" W x 18" D Seat Ht: 17.5" - 21.5" Back: 19" W x 28.5" H COM: 2 yds. COL: 40 sq. ft. 49 lbs.	Black Nylon	1,294	1,374	1,430	1,462	1,518	1,576	1,630	1,686	1,738	1,796	2,056	2,246
		Polished Aluminum	1,413	1,493	1,549	1,581	1,637	1,695	1,749	1,805	1,857	1,915	2,175	2,365

OPTIONS

-SS02	Seat Slider	\$76
-STC02	Soft Tread Casters	\$26
-STLC02	Soft Tread Self-Locking Casters	\$52

All shipments for this series will be blanket-wrapped as standard. If cartoning is required, a 5% upcharge will be added to each product. Please contact client services for additional information.

FACTION TASK | Designed by 5d Studio

Synchro-Tilt Mechanism

ORDERING REQUIREMENTS:

- Model number
- Base finish
- Upholstery selection
- Options, as applicable

MODEL	PRODUCT SPECIFICATIONS	BASE FINISH	FABRIC GRADES								LEATHER			
			COM	A	1	2	3	4	COL 5	6	7	8	L1	L2
1893 	Adjustable T-Arms 27.75" W x 23" D x 38.5" - 42.5" H Seat: 19.5" W x 18" D Seat Ht: 17.5" - 21.5" Back: 19.5" W x 21"H COM: 1.75 yds. COL: 35 sq. ft. 40 lbs.	Black Nylon	1,138	1,208	1,257	1,285	1,334	1,385	1,432	1,481	1,527	1,578	1,805	1,971
		Polished Aluminum	1,257	1,327	1,376	1,404	1,453	1,504	1,551	1,600	1,646	1,697	1,924	2,090

OPTIONS

-SS02	Seat Slider	\$76
-CT01	Chrome Trim Arm Detail	\$50
-STC02	Soft Tread Casters	\$26
-STLC02	Soft Tread Self-Locking Casters	\$52

FACTION GUEST + NESTING | Designed by 5d Studio



SPECIFICATIONS:

- Fully upholstered and poly-back models.
- Polypropylene back available in four colors.
- Tubular steel frame.
- Guest models available with three arm options: armless, metal cantilever arms or polypropylene loop arms.
- Nesting models feature flip-up seat and are offered armless or with metal cantilever arms.
- Please see below for back and arm finish options.
- Metal arm finish will match frame finish unless specified otherwise.
- For custom finish colors, please contact client services for pricing.
- Guest models with glides feature wall-saver leg design.
- Chairs are packaged three (3) to a carton.
- \$20 List carton break charge for less than three (3) chairs.
- Chairs stack up to 4-high standing or 5 with dolly. Please note that dolly is not recommended for caster models.
- 300 lb. weight capacity.
- All dimensions are nominal.
- Refer to terms and conditions for general information regarding fabrics, finishes, warranty, freight, complete condition of sales and more.

STANDARD METAL ARM/FRAME FINISH COLORS:

- #06 Charcoal Grey
- #90 Metallic Silver
- #91 Chrome (frame only)
- #92 Polished Aluminum (arm only)
- #95 Satin Black

PREMIUM METAL ARM/FRAME FINISH COLORS:

- #07 Gold Shimmer
- #08 Penny
- #09 Brown Sugar
- #83 Metallic Champagne
- #94 Cotton

POLYPROPYLENE COLORS:



- #136 Studio White
- #137 Simply Black
- #138 Soft Grey
- #139 Charcoal

All shipments for this series will be blanket-wrapped as standard. If cartoning is required, a 5% upcharge will be added to each product. Please contact client services for additional information.

FACTION GUEST | Designed by 5d Studio

ORDERING REQUIREMENTS:

- Model number
- Arm finish, as applicable
- Frame finish
- Upholstery selection
- Options, as applicable

MODEL	PRODUCT SPECIFICATIONS	FABRIC GRADES								LEATHER			
		COM	A	1	2	3	4	COL 5	6	7	8	L1	L2
18111-U 	Guest Chair, Upholstered Back, Armless, Glides 20.75" W x 22" D x 33" H Seat: 18" W x 19" D Seat Ht: 18" COM: 1.25 yds. COL: 25 sq. ft. 23 lbs.	538	588	623	643	678	715	748	783	816	852	1,015	1,133
18121-U 	Guest Chair, Upholstered Back, Metal Cantilever Arms, Glides 24.75" W x 22" D x 33" H Seat: 18" W x 19" D Seat Ht: 18" Arm Ht: 26.75" COM: 1.25 yds. COL: 25 sq. ft. 26 lbs.	596	646	681	701	736	773	806	841	874	910	1,073	1,191
18141-U 	Guest Chair, Upholstered Back, Poly Loop Arms, Glides 24.75" W x 22" D x 33" H Seat: 18" W x 19" D Seat Ht: 18" Arm Ht: 26.75" COM: 1.25 yds. COL: 25 sq. ft. 27 lbs.	577	627	662	682	717	754	787	822	855	891	1,054	1,172

OPTIONS



- PF02 Premium Metal Finish \$80
- VCT04 VCT Tile Glides \$24

All shipments for this series will be blanket-wrapped as standard. If cartoning is required, a 5% upcharge will be added to each product. Please contact client services for additional information.

FACTION GUEST | Designed by 5d Studio

ORDERING REQUIREMENTS:

- Model number
- Arm finish, as applicable
- Frame finish
- Upholstery selection
- Options, as applicable

MODEL	PRODUCT SPECIFICATIONS	FABRIC GRADES								LEATHER			
		COM	A	1	2	3	4	COL 5	6	7	8	L1	L2
18115-U 	Guest Chair, Upholstered Back, Armless, Casters 20.75" W x 22" D x 33" H Seat: 18" W x 19" D Seat Ht: 18" COM: 1.25 yds. COL: 25 sq. ft. 23 lbs.	538	588	623	643	678	715	748	783	816	852	1,015	1,133
18125-U 	Guest Chair, Upholstered Back, Metal Cantilever Arms, Casters 24.75" W x 22" D x 33" H Seat: 18" W x 19" D Seat Ht: 18" Arm Ht: 26.75" COM: 1.25 yds. COL: 25 sq. ft. 26 lbs.	596	646	681	701	736	773	806	841	874	910	1,073	1,191
18145-U 	Guest Chair, Upholstered Back, Poly Loop Arms, Casters 24.75" W x 22" D x 33" H Seat: 18" W x 19" D Seat Ht: 18" Arm Ht: 26.75" COM: 1.25 yds. COL: 25 sq. ft. 28 lbs.	577	627	662	682	717	754	787	822	855	891	1,054	1,172

OPTIONS



- PF02 Premium Metal Finish \$80
- STC02 Soft Tread Casters \$26

All shipments for this series will be blanket-wrapped as standard. If cartoning is required, a 5% upcharge will be added to each product. Please contact client services for additional information.

FACTION GUEST | Designed by 5d Studio

ORDERING REQUIREMENTS:

- Model number
- Poly back color
- Arm finish, as applicable
- Frame finish
- Upholstery selection
- Options, as applicable

MODEL	PRODUCT SPECIFICATIONS	FABRIC GRADES								LEATHER			
		COM	A	1	2	3	4	COL 5	6	7	8	L1	L2
18111-P 	Guest Chair, Poly Back Armless, Glides 20.75" W x 22" D x 33" H Seat: 18" W x 19" D Seat Ht: 18" COM: .75 yd. COL: 15 sq. ft. 22 lbs.	475	505	526	538	559	581	601	622	642	664	761	832
18121-P 	Guest Chair, Poly Back Metal Cantilever Arms, Glides 24.75" W x 22" D x 33" H Seat: 18" W x 19" D Seat Ht: 18" Arm Ht: 26.75" COM: .75 yd. COL: 15 sq. ft. 25 lbs.	533	563	584	596	617	639	659	680	700	722	819	890
18141-P 	Guest Chair, Poly Back Poly Loop Arms, Glides 24.75" W x 22" D x 33" H Seat: 18" W x 19" D Seat Ht: 18" Arm Ht: 26.75" COM: .75 yd. COL: 15 sq. ft. 27 lbs.	514	544	565	577	598	620	640	661	681	703	800	871

OPTIONS



- PF02 Premium Metal Finish \$80
- VCT04 VCT Tile Glides \$24

All shipments for this series will be blanket-wrapped as standard. If cartoning is required, a 5% upcharge will be added to each product. Please contact client services for additional information.

FACTION GUEST | Designed by 5d Studio

ORDERING REQUIREMENTS:

- Model number
- Poly back color
- Arm finish, as applicable
- Frame finish
- Upholstery selection
- Options, as applicable

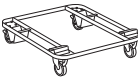
MODEL	PRODUCT SPECIFICATIONS	FABRIC GRADES								LEATHER			
		COM	A	1	2	3	4	COL 5	6	7	8	L1	L2
18115-P 	Guest Chair, Poly Back Armless, Casters 20.75" W x 22" D x 33" H Seat: 18" W x 19" D Seat Ht: 18" COM: .75 yd. COL: 15 sq. ft. 22 lbs.	475	505	526	538	559	581	601	622	642	664	761	832
18125-P 	Guest Chair, Poly Back Metal Cantilever Arms, Casters 24.75" W x 22" D x 33" H Seat: 18" W x 19" D Seat Ht: 18" Arm Ht: 26.75" COM: .75 yd. COL: 15 sq. ft. 25 lbs.	533	563	584	596	617	639	659	680	700	722	819	890
18145-P 	Guest Chair, Poly Back Poly Loop Arms, Casters 24.75" W x 22" D x 33" H Seat: 18" W x 19" D Seat Ht: 18" Arm Ht: 26.75" COM: .75 yd. COL: 15 sq. ft. 27 lbs.	514	544	565	577	598	620	640	661	681	703	800	871
1800 	Dolly (Black Finish Only) 24" W x 30" D x 6" H 37 lbs.	353											

OPTIONS



- PF02 Premium Metal Finish \$80
- STC02 Soft Tread Casters \$26

All shipments for this series will be blanket-wrapped as standard. If cartoning is required, a 5% upcharge will be added to each product. Please contact client services for additional information.

FACTION NESTING | Designed by 5d Studio

ORDERING REQUIREMENTS:

- Model number
- Arm finish, as applicable
- Frame finish
- Upholstery selection
- Options, as applicable

MODEL	PRODUCT SPECIFICATIONS	FABRIC GRADES								LEATHER			
		COM	A	1	2	3	4	COL 5	6	7	8	L1	L2
18715-U 	Nesting Chair, Fully Upholstered Armless, Casters 20.75" W x 22" D x 33" H Seat: 18" W x 19" D Seat Ht: 18" COM: 1.25 yds. COL: 25 sq. ft. 18 lbs.	555	605	640	660	695	732	765	800	833	869	1,032	1,150
18725-U 	Nesting Chair, Fully Upholstered Metal Cantilever Arms, Casters 24.75" W x 22" D x 33" H Seat: 18" W x 19" D Seat Ht: 18" Arm Ht: 26.75" COM: 1.25 yds. COL: 25 sq. ft. 21 lbs.	613	663	698	718	753	790	823	858	891	927	1,090	1,208

OPTIONS

NESTING DIMENSIONS

- PF02 Premium Metal Finish \$80
- STC02 Soft Tread Casters \$26

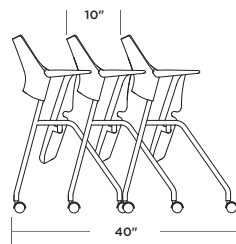



All shipments for this series will be blanket-wrapped as standard. If cartoning is required, a 5% upcharge will be added to each product. Please contact client services for additional information.

FACTION NESTING | Designed by 5d Studio

ORDERING REQUIREMENTS:

- Model number
- Poly back color
- Arm finish, as applicable
- Frame finish
- Upholstery selection
- Options, as applicable

MODEL	PRODUCT SPECIFICATIONS	FABRIC GRADES								LEATHER			
		COM	A	1	2	3	4	COL 5	6	7	8	L1	L2
18715-P 	Nesting Chair, Poly Back Armless, Casters 20.75" W x 22" D x 33" H Seat: 18" W x 19" D Seat Ht: 18" COM: .75 yd. COL: 15 sq. ft. 17 lbs.	500	530	551	563	584	606	626	647	667	689	786	857
18725-P 	Nesting Chair, Poly Back Metal Cantilever Arms, Casters 24.75" W x 22" D x 33" H Seat: 18" W x 19" D Seat Ht: 18" Arm Ht: 26.75" COM: .75 yd. COL: 15 sq. ft. 20 lbs.	558	588	609	621	642	664	684	705	725	747	844	915

OPTIONS

NESTING DIMENSIONS

- PF02 Premium Metal Finish \$80
- STC02 Soft Tread Casters \$26

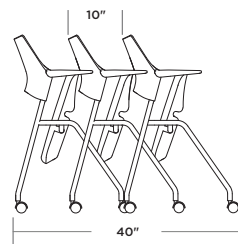

FACTION SWIVEL | Designed by 5d Studio



SPECIFICATIONS:

- Fully upholstered and poly-back models.
- Polypropylene back available in four colors.
- Armless and metal cantilever arm models.
- Arms and frame available in standard and premium finishes. See below for options.
- Arm finish will match frame finish unless specified otherwise.
- For custom finish colors, please contact client services for pricing.
- For armless models, please specify frame finish.
- Two base options: black nylon and polished aluminum.
- Fixed back height.
- Non-tilt, height adjustable swivel mechanism.
- 300 lb. weight capacity.
- All dimensions are nominal.
- Refer to terms and conditions for general information regarding fabrics, finishes, warranty, freight, complete condition of sales and more.

STANDARD METAL ARM/FRAME FINISH COLORS:

- #06 Charcoal Grey
- #90 Metallic Silver
- #91 Chrome (frame only)
- #92 Polished Aluminum (arm only)
- #95 Satin Black

PREMIUM METAL ARM/FRAME FINISH COLORS:

- #07 Gold Shimmer
- #08 Penny
- #09 Brown Sugar
- #83 Metallic Champagne
- #94 Cotton

POLYPROPYLENE BACK COLORS:



- #136 Studio White
- #137 Simply Black
- #138 Soft Grey
- #139 Charcoal

All shipments for this series will be blanket-wrapped as standard. If cartoning is required, a 5% upcharge will be added to each product. Please contact client services for additional information.

FACTION SWIVEL | Designed by 5d Studio

ORDERING REQUIREMENTS:

- Model number
- Arm finish, as applicable
- Frame finish
- Upholstery selection
- Options, as applicable

MODEL	PRODUCT SPECIFICATIONS	BASE FINISH	FABRIC GRADES								LEATHER			
			COM	A	1	2	3	4	COL 5	6	7	8	L1	L2
18113-U 	Fully Upholstered, Armless 20.75" W x 25.25" D x 32.5" - 37" H Seat: 18" W x 19" D Seat Ht: 18" Back: 18" W x 15" H COM: 1.25 yds. COL: 25 sq. ft. 28 lbs.	Black Nylon	753	803	838	858	893	930	963	998	1,031	1,067	1,230	1,348
		Polished Aluminum	872	922	957	977	1,012	1,049	1,082	1,117	1,150	1,186	1,349	1,467
18123-U 	Fully Upholstered, Metal Cantilever Arms 24.75" W x 25.25" D x 32.5" - 37" H Seat: 18" W x 19" D Seat Ht: 18" Back: 18" W x 15" H COM: 1.25 yds. COL: 25 sq. ft. 31 lbs.	Black Nylon	814	864	899	919	954	991	1,024	1,059	1,092	1,128	1,291	1,409
		Polished Aluminum	933	983	1,018	1,038	1,073	1,110	1,143	1,178	1,211	1,247	1,410	1,528

OPTIONS



-PF02	Premium Metal Finish (arms/frame only)	\$80
-STC02	Soft Tread Casters	\$26
-STLC02	Soft Tread Self-Locking Casters	\$52
-SK01	Stool Kit	\$90

All shipments for this series will be blanket-wrapped as standard. If cartoning is required, a 5% upcharge will be added to each product. Please contact client services for additional information.

FACTION SWIVEL | Designed by 5d Studio

ORDERING REQUIREMENTS:

- Model number
- Poly back color
- Arm finish, as applicable
- Frame finish
- Upholstery selection
- Options, as applicable

MODEL	PRODUCT SPECIFICATIONS	BASE FINISH	FABRIC GRADES								LEATHER			
			COM	A	1	2	3	4	COL 5	6	7	8	L1	L2
18113-P 	Poly Back, Armless 20.75" W x 25.25" D x 32.5" - 37" H Seat: 18" W x 19" D Seat Ht: 18" Back: 18" W x 15" H COM: .75 yd. COL: 15 sq. ft. 27 lbs.	Black Nylon	699	729	750	762	783	805	825	846	866	888	985	1,056
		Polished Aluminum	818	848	869	881	902	924	944	965	985	1,007	1,104	1,175
18123-P 	Poly Back, Metal Cantilever Arms 24.75" W x 25.25" D x 32.5" - 37" H Seat: 18" W x 19" D Seat Ht: 18" Back: 18" W x 15" H COM: .75 yd. COL: 15 sq. ft. 30 lbs.	Black Nylon	759	789	810	822	843	865	885	906	926	948	1,045	1,116
		Polished Aluminum	878	908	929	941	962	984	1,004	1,025	1,045	1,067	1,164	1,235

OPTIONS

-PF02	Premium Metal Finish (arms/frame only)	\$80
-STC02	Soft Tread Casters	\$26
-STLC02	Soft Tread Self-Locking Casters	\$52
-SK01	Stool Kit	\$90

FACTION SWIVEL | Designed by 5d Studio

UPHOLSTERY COMBINATIONS:

- For upholstery combinations, refer to the pricing below.
- When combining two COM/COV/COL fabrics, or fabrics with the same grade, add \$85 List per unit.
- When combining three or more COM/COV/COL fabrics, or fabrics with the same grade, add \$115 List per unit.
- When combining different grades of fabric, price will be based on the highest grade specified.
- Two-tine upholstery examples and yardage requirements for the most common combinations are listed below. Additional combinations available; please contact Client Services for yardage requirements and pricing.
- Note: Yardage amounts are based on fabric which is plain (i.e. non-directional) and a full 54" wide.
- Appropriate upholstery code must be included.

Code	FC1
<u>Model</u>	<u>COM Requirement</u>
All Fully Upholstered Models	Back = .75 yd. Seat = .75 yd.

FLING® GUEST | Designed by 5d Studio



SPECIFICATIONS:

- Two base options available: 4-leg base or swivel base with self-return.
- Bases available in standard and premium finishes. See below for options.
- For custom finish colors, please contact client services for pricing.
- 300 lb. weight capacity.
- All dimensions are nominal.
- Refer to terms and conditions for general information regarding fabrics, finishes, warranty, freight, complete condition of sales and more.

STANDARD METAL BASE FINISH COLORS:

- #06 Charcoal Grey
- #90 Metallic Silver
- #91 Chrome (4-leg base only)
- #92 Polished Aluminum (swivel base only)
- #95 Satin Black

PREMIUM METAL BASE FINISH COLORS:



- #07 Gold Shimmer
- #08 Penny
- #09 Brown Sugar
- #83 Metallic Champagne
- #94 Cotton

All shipments for this series will be blanket-wrapped as standard. If cartoning is required, a 5% upcharge will be added to each product. Please contact client services for additional information.

FLING® GUEST | Designed by 5d Studio

ORDERING REQUIREMENTS:

- Model number
- Base finish
- Upholstery selection
- Options, as applicable

MODEL	PRODUCT SPECIFICATIONS	FABRIC GRADES										LEATHER	
		COM	A	1	2	3	4	COL 5	6	7	8	L1	L2
 <p>2110-U Guest Chair, 4-Leg Base 23.75" W x 24" D x 30.25" H Seat: 19" W x 19" D Seat Ht: 17.5" COM: 2.75 yds. COL: 55 sq. ft. 20 lbs.</p>	929	1,039	1,116	1,160	1,237	1,317	1,391	1,468	1,540	1,620	1,977	2,238	
 <p>2120-U Guest Chair, Swivel Base 23.75" W x 24" D x 30.25" H Seat: 19" W x 19" D Seat Ht: 17.5" COM: 2.75 yds. COL: 55 sq. ft. 20 lbs.</p>	1,137	1,247	1,324	1,368	1,445	1,525	1,599	1,676	1,748	1,828	2,185	2,446	

OPTIONS

- PF02 Premium Metal Base Finish (4-leg base) \$80
- PF04 Premium Metal Base Finish (swivel base) \$135
- VCT04 VCT Tile Glides (4-leg base) \$24

FLING® GUEST | Designed by 5d Studio

UPHOLSTERY COMBINATIONS:

- For upholstery combinations, refer to the pricing below.
- When combining two COM/COV/COL fabrics, or fabrics with the same grade, add \$85 List per unit.
- When combining three or more COM/COV/COL fabrics, or fabrics with the same grade, add \$115 List per unit.
- When combining different grades of fabric, price will be based on the highest grade specified.
- Two-tone upholstery examples and yardage requirements for the most common combinations are listed below. Additional combinations available; please contact client services for yardage requirements and pricing.
- Note: Yardage amounts are based on fabric which is plain (i.e. non-directional) and a full 54" wide.
- Appropriate upholstery code must be included.



Code FG2

Model COM Requirement

2110-U Inside/Outside Back & Seat Cushion = 1.75 yds.

2120-U Balance of Chair = 1.5 yds.



Code FG3

Model COM Requirement

2110-U Inside/Outside Back = 1 yd.

2120-U Balance of Chair = 2.25 yds.



Code FG4

Model COM Requirement

2110-U Seat Cushion Only = .75 yd.

2120-U Balance of Chair = 2.5 yds.

All shipments for this series will be blanket-wrapped as standard. If cartoning is required, a 5% upcharge will be added to each product. Please contact client services for additional information.

FLING® LOUNGE | Designed by 5d Studio

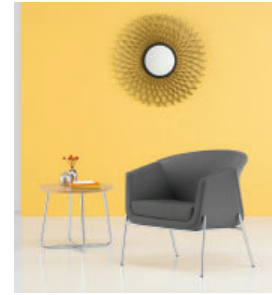

SPECIFICATIONS:

- Two base options available: 4-leg base or swivel base with self-return.
- Bases available in standard and premium finishes. See below for options.
- For custom finish colors, please contact client services for pricing.
- 300 lb. weight capacity.
- All dimensions are nominal.
- Refer to terms and conditions for general information regarding fabrics, finishes, warranty, freight, complete condition of sales and more.

STANDARD METAL BASE FINISH COLORS:

- #06 Charcoal Grey
- #90 Metallic Silver
- #91 Chrome (sled base only)
- #92 Polished Aluminum (swivel base only)
- #95 Satin Black

PREMIUM METAL BASE FINISH COLORS:



- #07 Gold Shimmer
- #08 Penny
- #09 Brown Sugar
- #83 Metallic Champagne
- #94 Cotton

All shipments for this series will be blanket-wrapped as standard. If cartoning is required, a 5% upcharge will be added to each product. Please contact client services for additional information.

FLING® LOUNGE | Designed by 5d Studio

ORDERING REQUIREMENTS:

- Model number
- Base finish
- Upholstery selection
- Options, as applicable

MODEL	PRODUCT SPECIFICATIONS	FABRIC GRADES								LEATHER			
		COM	A	1	2	3	4	COL 5	6	7	8	L1	L2
2170-U 	Lounge Chair, 4-Leg Base 28.5" W x 27.75" D x 30" H Seat: 22" W x 20" D Seat Ht: 17" COM: 3.75 yds. COL: 75 sq. ft. 28 lbs.	1,253	1,403	1,508	1,568	1,673	1,782	1,883	1,988	2,086	2,195	2,682	3,038
2180-U 	Lounge Chair, Swivel Base 28.5" W x 27.75" D x 30" H Seat: 22" W x 20" D Seat Ht: 17" COM: 3.75 yds. COL: 75 sq. ft. 28 lbs.	1,441	1,591	1,696	1,756	1,861	1,970	2,071	2,176	2,274	2,383	2,870	3,226

OPTIONS

- PF02 Premium Metal Base Finish (4-leg base) \$80
- PF04 Premium Metal Base Finish (swivel base) \$135
- VCT04 VCT Tile Glides (4-leg base) \$24

FLING® LOUNGE | Designed by 5d Studio

UPHOLSTERY COMBINATIONS:

- For upholstery combinations, refer to the pricing below.
- When combining two COM/COV/COL fabrics, or fabrics with the same grade, add \$85 List per unit.
- When combining three or more COM/COV/COL fabrics, or fabrics with the same grade, add \$115 List per unit.
- When combining different grades of fabric, price will be based on the highest grade specified.
- Two-tone upholstery examples and yardage requirements for the most common combinations are listed below. Additional combinations available; please contact Client Services for yardage requirements and pricing.
- Note: Yardage amounts are based on fabric which is plain (i.e. non-directional) and a full 54" wide.
- Appropriate upholstery code must be included.



Code FL2

Model COM Requirement

2170-U Inside/Outside Back & Seat Cushion = 2.25 yds.

2180-U Balance of Chair = 2 yds.



Code FL3

Model COM Requirement

2170-U Inside/Outside Back = 1.25 yds.

2180-U Balance of Chair = 3 yds.



Code FL4

Model COM Requirement

2170-U Seat Cushion Only = 1 yd.

2180-U Balance of Chair = 3.25 yds.

FLURRY GUEST | Designed by Francisco Romero of PhiDesign



SPECIFICATIONS:

- High-density polypropylene seat and back available in eight colors.
- ½" diameter steel rod frame.
- #91 Chrome frame finish.
- Wall-saver leg design.
- Stacks up to 10 high standing or 25 with dolly.
- Optional clear glides for hard surface flooring.
- Optional clear ganging connectors available.
- Chairs are packaged four (4) to a carton.
- Orders of fewer than four (4) chairs are subject to a \$20 List upcharge per chair.
- 300 lb. weight capacity.
- All dimensions are nominal.
- Refer to terms and conditions for general information regarding fabrics, finishes, warranty, freight, complete condition of sales and more.

POLYPROPYLENE COLORS:

- #30 Very Black
- #31 Medium Grey
- #32 Soft White
- #40 Cocoa
- #42 Mimosa
- #44 Sky
- #46 Scarlet
- #48 Key Lime



All shipments for this series will be blanket-wrapped as standard. If cartoning is required, a 5% upcharge will be added to each product. Please contact client services for additional information.

FLURRY GUEST | Designed by Francisco Romero of PhiDesign



ORDERING REQUIREMENTS:

- Model number
- Seat/back color
- Options, as applicable

	MODEL	SEAT/BACK COLOR		LIST
	2410-30	Very Black	19.75" W x 23" D x 32" H Seat: 18.25" W x 18.25" D Seat Ht: 18" Weight: 16 lbs.	291
	2410-31	Medium Grey		
	2410-32	Soft White		
	2410-40	Cocoa		
	2410-42	Mimosa		
	2410-44	Sky		
	2410-46	Scarlet		
	2410-48	Key Lime		
	2400	Dolly (Black Finish Only)	Overall: 23" W x 33" D x 19" H Weight: 19 lbs.	314

OPTIONS

- CG02 Clear Glides (set of 4) \$10
- GC02 Ganging Connectors (set of 4) \$12

FLURRY STOOL | Designed by Francisco Romero of PhiDesign



SPECIFICATIONS:

- Bar-height stool with stacking capability.
- High-density polypropylene seat and back available in eight colors.
- ½" diameter steel rod frame.
- #91 Chrome frame finish.
- Wall-saver leg design.
- Footrest with 9" clearance from floor.
- Stacks up to 8 high.
- 350 lb. weight capacity.
- Optional clear glides for hard surface flooring.
- All dimensions are nominal.
- Refer to terms and conditions for general information regarding fabrics, finishes, warranty, freight, complete condition of sales and more.

POLYPROPYLENE COLORS:

- #30 Very Black
- #31 Medium Grey
- #32 Soft White
- #40 Cocoa
- #42 Mimosa
- #44 Sky
- #46 Scarlet
- #48 Key Lime

All shipments for this series will be blanket-wrapped as standard. If cartoning is required, a 5% upcharge will be added to each product. Please contact client services for additional information.

FLURRY STOOL | Designed by Francisco Romero of PhiDesign

ORDERING REQUIREMENTS:

- Model number
- Seat/back color
- Options, as applicable

	MODEL	SEAT/BACK COLOR		LIST
	2430-30	Very Black	19.75" W x 23" D x 43" H	439
	2430-31	Medium Grey	Seat: 18.25" W x 18.25" D	
	2430-32	Soft White	Seat Ht: 30"	
	2430-40	Cocoa	Weight: 24 lbs.	
	2430-42	Mimosa		
	2430-44	Sky		
	2430-46	Scarlet		
	2430-48	Key Lime		

OPTIONS

-CG02 Clear Glides (set of 4) \$10

GOGO BENCH + LOUNGE | Designed by Qdesign



PRODUCT FEATURES:

- Benches and lounge seating available with casters or glides.
- All dimensions are nominal.
- Refer to terms and conditions for general information regarding fabrics, finishes, warranty, freight, complete condition of sales and more.

BENCHES:

- Single seat and two-seat models.
- Single seat models offered with casters or glides. Two-seat models available with glides only.
- Single seat benches feature 300 lb. weight capacity.
- Two-seat benches feature 600 lb. weight capacity.

LOUNGE SEATING:

- Arm and armless lounge and love seat models.
- Lounge chairs offered with casters or glides.
- Caster/glide combination also offered to limit movement while seated, but still allow for easy maneuverability when not in use.
- Lounge chairs offered with casters or glides. Love seats available with glides only.
- Optional leather pull handle on lounge models (not available on love seats).
- Pull handle is offered in four standard leather color options. Please refer to listing below.
- Lounge chairs feature 300 lb. weight capacity.
- Love seats feature 600 lb. weight capacity.

STANDARD LEATHER PULL HANDLE COLORS (LOUNGE MODELS ONLY):



- Black
- Bright White
- Saddle
- Flint

All shipments for this series will be blanket-wrapped as standard. If cartoning is required, a 5% upcharge will be added to each product. Please contact client services for additional information.

GOGO BENCHES | Designed by Qdesign

ORDERING REQUIREMENTS:

- Model number
- Upholstery selection
- Options, as applicable

MODEL	PRODUCT SPECIFICATIONS	FABRIC GRADES								LEATHER			
		COM	A	1	2	3	4	COL 5	6	7	8	L1	L2
6750 	Single Seat Bench, Glides Overall: 24" W x 22.5" D x 16.75 H" COM: 2.25 yds. COL: 45 sq. ft. 20 lbs.	772	862	925	961	1,024	1,090	1,150	1,213	1,272	1,337	1,630	1,843
6755 	Single Seat Bench, Casters Overall: 24" W x 22.5" D x 16.75 H" COM: 2.25 yds. COL: 45 sq. ft. 20 lbs.	772	862	925	961	1,024	1,090	1,150	1,213	1,272	1,337	1,630	1,843
6760 	2-Seat Bench, Glides Overall: 48" W x 22.5" D x 16.75 H" COM: 3 yds. COL: 60 sq. ft. 33 lbs.	1,277	1,397	1,481	1,529	1,613	1,700	1,781	1,865	1,943	2,030	2,420	2,705

OPTIONS

-FG04 Felt Glides \$40

GOGO BENCHES | Designed by Qdesign

UPHOLSTERY COMBINATIONS:

- For upholstery combinations, refer to the pricing below.
- When combining two COM/COV/COL fabrics, or fabrics with the same grade, add \$85 List per unit.
- When combining three or more COM/COV/COL fabrics, or fabrics with the same grade, add \$115 List per unit.
- When combining different grades of fabric, price will be based on the highest grade specified.
- Two-tone upholstery examples and yardage requirements for the most common combinations are listed below. Additional combinations available; please contact client Services for yardage requirements and pricing.
- Note: Yardage amounts are based on fabric which is plain (i.e. non-directional) and a full 54" wide.
- Appropriate upholstery code must be included.

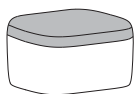

Code	GG9
<u>Model</u>	<u>COM Requirement</u>
6750	Seat Cushion = 1 yd.
6755	Balance of Bench = 1.25 yds.

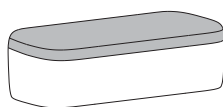

Code	GG10
<u>Model</u>	<u>COM Requirement</u>
6760	Seat Cushion = 1.25 yds.
	Balance of Bench = 1.75 yds.







All shipments for this series will be blanket-wrapped as standard. If cartoning is required, a 5% upcharge will be added to each product. Please contact client services for additional information.

GOGO LOUNGE | Designed by Qdesign

ORDERING REQUIREMENTS:

- Model number
- Upholstery selection
- Options, as applicable

Note: caster/glide combination limits movement while seated, but still allows for easy maneuverability when not in use.

MODEL	PRODUCT SPECIFICATIONS	FABRIC GRADES										LEATHER	
		COM	A	1	2	3	4	COL 5	6	7	8	L1	L2
6710 	Lounge Chair, Armless, Glides 24" W x 27.25" D x 32" H Seat: 23.25" W x 18.25" D Seat Ht: 16.75" COM: 3 yds. COL: 60 sq. ft. 42 lbs.	1,140	1,260	1,344	1,392	1,476	1,563	1,644	1,728	1,806	1,893	2,283	2,568
6715 	Lounge Chair, Armless, Casters 24" W x 27.25" D x 32" H Seat: 23.25" W x 18.25" D Seat Ht: 16.75" COM: 3 yds. COL: 60 sq. ft. 42 lbs.	1,140	1,260	1,344	1,392	1,476	1,563	1,644	1,728	1,806	1,893	2,283	2,568
6712 	Lounge Chair, Armless, Casters/Glides 24" W x 27.25" D x 32" H Seat: 23.25" W x 18.25" D Seat Ht: 16.75" COM: 3 yds. COL: 60 sq. ft. 42 lbs.	1,140	1,260	1,344	1,392	1,476	1,563	1,644	1,728	1,806	1,893	2,283	2,568
6711 	Lounge Chair, Arms, Glides 28.5" W x 29.25" D x 32" H Seat: 23.25" W x 18.25" D Seat Ht: 16.75" COM: 5.5 yds. COL: 110 sq. ft. 72 lbs.	1,485	1,705	1,859	1,947	2,101	2,261	2,409	2,563	2,706	2,866	3,581	4,103
6716 	Lounge Chair, Arms, Casters 28.5" W x 29.25" D x 32" H Seat: 23.25" W x 18.25" D Seat Ht: 16.75" COM: 5.5 yds. COL: 110 sq. ft. 72 lbs.	1,485	1,705	1,859	1,947	2,101	2,261	2,409	2,563	2,706	2,866	3,581	4,103
6717 	Lounge Chair, Arms, Casters/Glides 28.5" W x 29.25" D x 32" H Seat: 23.25" W x 18.25" D Seat Ht: 16.75" COM: 5.5 yds. COL: 110 sq. ft. 72 lbs.	1,485	1,705	1,859	1,947	2,101	2,261	2,409	2,563	2,706	2,866	3,581	4,103

OPTIONS

-P02-BW	Leather Pull Handle, Bright White	\$125
-P02-S	Leather Pull Handle, Saddle	\$125
-P02-F	Leather Pull Handle, Flint	\$125
-P02-B	Leather Pull Handle, Black	\$125
-FG04	Felt Glides	\$40

All shipments for this series will be blanket-wrapped as standard. If cartoning is required, a 5% upcharge will be added to each product. Please contact client services for additional information.

GOGO LOUNGE | Designed by Qdesign

ORDERING REQUIREMENTS:

- Model number
- Upholstery selection
- Options, as applicable

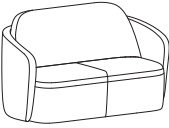
MODEL	PRODUCT SPECIFICATIONS	FABRIC GRADES								LEATHER			
		COM	A	1	2	3	4	COL 5	6	7	8	L1	L2
6720 	Love Seat, Armless, Glides 48" W x 27.25" D x 32" H Seat: 47.5" W x 18.25" D Seat Ht: 16.75" COM: 5 yds. COL: 100 sq. ft. 60 lbs.	1,626	1,826	1,966	2,046	2,186	2,331	2,466	2,606	2,736	2,881	3,531	4,006
6721 	Love Seat, Arms, Glides 53" W x 29.25" D x 32" H Seat: 47.5" W x 18.25" D Seat Ht: 16.75" COM: 9 yds. COL: 180 sq. ft. 103 lbs.	2,079	2,479	2,759	2,919	3,199	3,489	3,759	4,039	4,299	4,589	5,889	6,839

OPTIONS

-FG04 Felt Glides \$40

GOGO LOUNGE | Two-Tone Upholstery

UPHOLSTERY COMBINATIONS:

- For upholstery combinations, refer to the pricing below.
- When combining two COM/COV/COL fabrics, or fabrics with the same grade, add \$85 List per unit.
- When combining three or more COM/COV/COL fabrics, or fabrics with the same grade, add \$115 List per unit.
- When combining different grades of fabric, price will be based on the highest grade specified.
- Two-tone upholstery examples and yardage requirements for the most common combinations are listed below. Additional combinations available; please contact client Services for yardage requirements and pricing.
- Note: Yardage amounts are based on fabric which is plain (i.e. non-directional) and a full 54" wide.
- Appropriate upholstery code must be included.

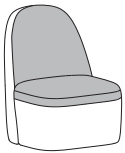

Code GG1

Model COM Requirement

6710 Front of Back & Seat Cushion = 1.25 yds.

6712 Balance of Chair = 2 yds.

6715

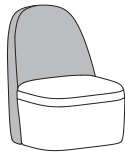

Code GG2

Model COM Requirement

6710 Back Upholstery = 2 yds.

6712 Balance of Chair = 1.5 yds.

6715



Code GG3

Model COM Requirement

6711 Back & Seat Cushion = 2.25 yds.

6716 Balance of Chair = 3.75 yds.

6717



Code GG4

Model COM Requirement

6711 Arm Panels/Outer Shell = 3 yds.

6716 Balance of Chair = 3 yds.

6717

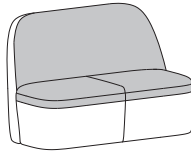

Code GG5

Model COM Requirement

6720 Front of Back & Seat Cushion = 2.25 yds.

Balance of Love Seat = 3 yds.

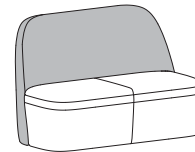

Code GG6

Model COM Requirement

6720 Back Upholstery = 3 yds.

Balance of Love Seat = 2.5 yds.

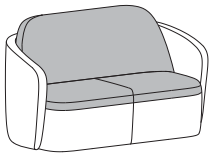

Code GG7

Model COM Requirement

6721 Back & Seat Cushion = 3.75 yds.

Balance of Love Seat = 5.25 yds.

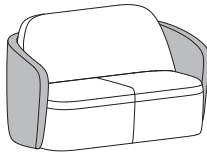

Code GG8

Model COM Requirement

6721 Arm Panels/Outer Shell = 4 yds.

Balance of Love Seat = 5 yds.

All shipments for this series will be cartoned as standard. If blanket-wrapped shipping is required, please contact client services for additional information.

GRADIENT



SPECIFICATIONS:

- Breathable mesh suspension back and fully upholstered seat.
- Mesh suspension available in three colors. Please refer to listing below.
- Armless, adjustable t-arm and cantilever arm models.
- Adjustable t-arms available with black or chrome trim detail.
- Unless specified otherwise, t-arm trim finish will match base finish.
- 4" arm height adjustment as standard.
- Cantilever arms available in black or polished aluminum.
- Two base options: black nylon and polished aluminum.
- 300 lb. weight capacity.
- Ships KD (knocked down).
- All dimensions are nominal.
- Two mechanism options: knee-tilt and swivel-tilt with tilt lock. Refer to pages 13-15 for mechanism guide.
- Tilt function is disabled on stool models.
- Refer to terms and conditions for general information regarding fabrics, finishes, warranty, freight, complete condition of sales and more.

MESH SUSPENSION COLORS:

- #107 Sterling
- #109 Night
- #126 Wheat





All shipments for this series will be cartoned as standard. If blanket-wrapped shipping is required, please contact client services for additional information.

GRADIENT

Swivel-Tilt with Tilt Lock Mechanism

ORDERING REQUIREMENTS:

- Model number
- Mesh suspension color
- Base finish
- Seat upholstery selection
- Options, as applicable

MODEL	PRODUCT SPECIFICATIONS	BASE FINISH	FABRIC GRADES								LEATHER			
			COM	A	1	2	3	4	COL 5	6	7	8	L1	L2
3451 	Armless 20" W x 25.25" D x 37" - 42" H Seat: 21.5" W x 19.5" D Seat Ht: 17" - 22" Back: 20" W x 25.5" H COM: .75 yd. COL: 15 sq. ft. 22 lbs.	Black Nylon	646	676	697	709	730	752	772	793	813	835	932	1,003
		Polished Aluminum	725	755	776	788	809	831	851	872	892	914	1,011	1,082
3453 	Adjustable T-Arms 24" W x 25.25" D x 37" - 42" H Seat: 21.5" W x 19.5" D Seat Ht: 17" - 22" Back: 20" W x 25.5" H COM: .75 yd. COL: 15 sq. ft. 26 lbs.	Black Nylon	688	718	739	751	772	794	814	835	855	877	974	1,045
		Polished Aluminum	767	797	818	830	851	873	893	914	934	956	1,053	1,124
3454 	Black Cantilever Arms 24" W x 25.25" D x 37" - 42" H Seat: 21.5" W x 19.5" D Seat Ht: 17" - 22" Back: 20" W x 25.5" H COM: .75 yd. COL: 15 sq. ft. 26 lbs.	Black Nylon	688	718	739	751	772	794	814	835	855	877	974	1,045
		Polished Aluminum	767	797	818	830	851	873	893	914	934	956	1,053	1,124
3455 	Polished Aluminum Cantilever Arms 24" W x 25.25" D x 37" - 42" H Seat: 21.5" W x 19.5" D Seat Ht: 17" - 22" Back: 20" W x 25.5" H COM: .75 yd. COL: 15 sq. ft. 26 lbs.	Black Nylon	801	831	852	864	885	907	927	948	968	990	1,087	1,158
		Polished Aluminum	880	910	931	943	964	986	1,006	1,027	1,047	1,069	1,166	1,237

OPTIONS

-STC02	Soft Tread Casters	\$26
-GD04	Glides	\$26
-J01	Jury Base (black only)	\$150
-SK01	Stool Kit [†]	\$90

[†] Tilt function is disabled on stool models.





All shipments for this series will be cartoned as standard. If blanket-wrapped shipping is required, please contact client services for additional information.

GRADIENT

Knee-Tilt Mechanism

ORDERING REQUIREMENTS:

- Model number
- Mesh suspension color
- Base finish
- Seat upholstery selection
- Options, as applicable

MODEL	PRODUCT SPECIFICATIONS	BASE FINISH	FABRIC GRADES								LEATHER			
			COM	A	1	2	3	4	COL 5	6	7	8	L1	L2
3471 	Armless 20" W x 25.25" D x 37" - 42" H Seat: 21.5" W x 19.5" D Seat Ht: 17" - 22" Back: 20" W x 25.5" H COM: . 75 yd. COL: 15 sq. ft. 22 lbs.	Black Nylon	673	703	724	736	757	779	799	820	840	862	959	1,030
		Polished Aluminum	752	782	803	815	836	858	878	899	919	941	1,038	1,109
3473 	Adjustable T-Arms 24" W x 25.25" D x 37" - 42" H Seat: 21.5" W x 19.5" D Seat Ht: 17" - 22" Back: 20" W x 25.5" H COM: . 75 yd. COL: 15 sq. ft. 26 lbs.	Black Nylon	713	743	764	776	797	819	839	860	880	902	999	1,070
		Polished Aluminum	792	822	843	855	876	898	918	939	959	981	1,078	1,149
3474 	Black Cantilever Arms 24" W x 25.25" D x 37" - 42" H Seat: 21.5" W x 19.5" D Seat Ht: 17" - 22" Back: 20" W x 25.5" H COM: . 75 yd. COL: 15 sq. ft. 26 lbs.	Black Nylon	713	743	764	776	797	819	839	860	880	902	999	1,070
		Polished Aluminum	792	822	843	855	876	898	918	939	959	981	1,078	1,149
3475 	Polished Aluminum Cantilever Arms 24" W x 25.25" D x 37" - 42" H Seat: 21.5" W x 19.5" D Seat Ht: 17" - 22" Back: 20" W x 25.5" H COM: . 75 yd. COL: 15 sq. ft. 26 lbs.	Black Nylon	826	856	877	889	910	932	952	973	993	1,015	1,112	1,183
		Polished Aluminum	905	935	956	968	989	1,011	1,031	1,052	1,072	1,094	1,191	1,262

OPTIONS

-STC02	Soft Tread Casters	\$26
-GD04	Glides	\$26
-J01	Jury Base (black only)	\$150
-SK01	Stool Kit'	\$90

HADO BENCHES | Designed by Qdesign



SPECIFICATIONS:

- Square and rectangular benches and ottomans with wood legs.
- Wood legs offered in all standard and custom finishes on ash. Please refer to standard finish card.
- For custom wood finishes, please contact client services and add one-time upcharge of \$450 List per color per order.
- 22" ottoman and 30" square bench feature 275 lb. weight capacity.
- 36" square bench, 48" rectangular bench and 60" rectangular bench feature 550 lb. weight capacity.
- Ottoman features 7¾" leg height clearance.
- Square and rectangular benches feature 12½" leg height clearance.
- Ships KD (knocked down). Leg assembly required.
- All dimensions are nominal.
- Refer to terms and conditions for general information regarding fabrics, finishes, warranty, freight, complete condition of sales and more.

MINI-TAP POWER UNITS:

- Available on all benches and ottomans.
- Dimensions: 3" W x 3" D x 1.75" H
- Black and white color options.
- 72" electrical cord (no hardware option or daisy chain feature available for this series).
- Placement is located under seat.
- Please specify front, left side or right side placement, as seated.
- For left or right side placement, unit will be centered as standard.
- For front placement, please specify left, center or right, as seated.
- UL listed.

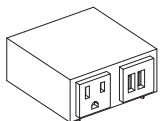

Mini-Tap 1 (MT1)

- One outlet and two USB charging ports.

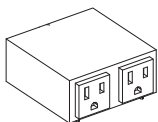

Mini-Tap 2 (MT2)



- Two outlets.

All shipments for this series will be blanket-wrapped as standard. If cartoning is required, a 5% upcharge will be added to each product. Please contact client services for additional information.

HADO BENCHES | Designed by Qdesign

ORDERING REQUIREMENTS:

- Model number
- Leg finish
- Upholstery selection
- Options, as applicable

MODEL	PRODUCT SPECIFICATIONS	FABRIC GRADES										LEATHER	
		COM	A	1	2	3	4	COL 5	6	7	8	L1	L2
63522 	22" Square Ottoman 22" W x 22" D x 15.75" H COM: 1.25 yds. COL: 25 sq. ft. 19 lbs.	911	961	996	1,016	1,051	1,088	1,121	1,156	1,189	1,225	1,388	1,506
63530 	30" Square Bench 30" W x 30" D x 19" H COM: 1.5 yds. COL: 30 sq. ft. 27 lbs.	1,113	1,173	1,215	1,239	1,281	1,325	1,365	1,407	1,446	1,490	1,685	1,827
63536 	36" Square Bench 36" W x 36" D x 19" H COM: 1.75 yds. COL: 35 sq. ft. 37 lbs.	1,386	1,456	1,505	1,533	1,582	1,633	1,680	1,729	1,775	1,826	2,053	2,219

OPTIONS

-NS05	Non-Skid Glides	\$42
-MT1-B	Mini-Tap Power Unit (1 power, 2 USB), Black	\$494
-MT1-W	Mini-Tap Power Unit (1, power, 2 USB), White	\$494
-MT2-B	Mini-Tap Power Unit (2 power), Black	\$442
-MT2-W	Mini-Tap Power Unit (2 power), White	\$442

All shipments for this series will be blanket-wrapped as standard. If cartoning is required, a 5% upcharge will be added to each product. Please contact client services for additional information.

HADO BENCHES | Designed by Qdesign

ORDERING REQUIREMENTS:

- Model number
- Leg finish
- Upholstery selection
- Options, as applicable

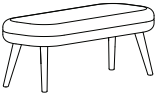
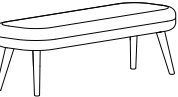
MODEL	PRODUCT SPECIFICATIONS	FABRIC GRADES										LEATHER	
		COM	A	1	2	3	4	COL 5	6	7	8	L1	L2
63548 	48" Rectangular Bench 48" W x 20" D x 19" H COM: 2 yds. COL: 40 sq. ft. 38 lbs.	1,360	1,440	1,496	1,528	1,584	1,642	1,696	1,752	1,804	1,862	2,122	2,312
63560 	60" Rectangular Bench 60" W x 20" D x 19" H COM: 2.75 yds. COL: 55 sq. ft. 45 lbs.	1,394	1,504	1,581	1,625	1,702	1,782	1,856	1,933	2,005	2,085	2,442	2,703

OPTIONS

-NS05	Non-Skid Glides	\$42
-MT1-B	Mini-Tap Power Unit (1 power, 2 USB), Black	\$494
-MT1-W	Mini-Tap Power Unit (1, power, 2 USB), White	\$494
-MT2-B	Mini-Tap Power Unit (2 power), Black	\$442
-MT2-W	Mini-Tap Power Unit (2 power), White	\$442

HADO BENCHES | Designed by Qdesign

UPHOLSTERY COMBINATIONS:

- For upholstery combinations, refer to the pricing below.
- When combining two COM/COV/COL fabrics, or fabrics with the same grade, add \$85 List per unit.
- When combining three or more COM/COV/COL fabrics, or fabrics with the same grade, add \$115 List per unit.
- When combining different grades of fabric, price will be based on the highest grade specified.
- Two-tone upholstery examples and yardage requirements for the most common combinations are listed below. Additional combinations available; please contact client Services for yardage requirements and pricing.
- Note: Yardage amounts are based on fabric which is plain (i.e. non-directional) and a full 54" wide.
- Appropriate upholstery code must be included.



Code **HB1**
Model COM Requirement
 63522 Upholstered Platform = .5 yd.
 Balance of Bench = .75 yd.



Code **HB2**
Model COM Requirement
 63530 Upholstered Platform = .5 yd.
 Balance of Bench = 1 yd.



Code **HB3**
Model COM Requirement
 63536 Upholstered Platform = .5 yd.
 Balance of Bench = 1 yd.

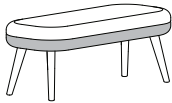

Code **HB4**
Model COM Requirement
 63548 Upholstered Platform = .75 yd.
 Balance of Bench = 1.25 yds.

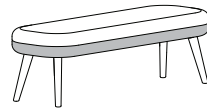

Code **HB5**
Model COM Requirement
 63560 Upholstered Platform = 2 yds.
 Balance of Bench = 1 yd.

HADO GUEST | Designed by Qdesign



SPECIFICATIONS:

- Two base options: 4-leg metal and 4-leg wood.
- Metal legs available in standard and premium finishes. See below for options.
- For custom finish colors, please contact client services for pricing.
- Wood legs offered in all standard and custom finishes on Ash. Please refer to standard finish card.
- For custom wood finishes, please contact client services and add one-time upcharge of \$450 List per color per order.
- 300 lb. weight capacity.
- All dimensions are nominal.
- Refer to terms and conditions for general information regarding fabrics, finishes, warranty, freight, complete condition of sales and more.

STANDARD METAL LEG FINISH COLORS:

- #06 Charcoal Grey
- #90 Metallic Silver
- #91 Chrome
- #95 Satin Black

PREMIUM METAL LEG FINISH COLORS:



- #07 Gold Shimmer
- #08 Penny
- #09 Brown Sugar
- #83 Metallic Champagne
- #94 Cotton

All shipments for this series will be blanket-wrapped as standard. If cartoning is required, a 5% upcharge will be added to each product. Please contact client services for additional information.

HADO GUEST | Designed by Qdesign

ORDERING REQUIREMENTS:

- Model number
- Leg finish
- Upholstery selection
- Options, as applicable

MODEL	PRODUCT SPECIFICATIONS	FABRIC GRADES										LEATHER	
		COM	A	1	2	3	4	COL 5	6	7	8	L1	L2
63111 	Guest Chair, 4-Leg Metal Base 18" W x 23.5" D x 31.5" H Seat: 18" W x 17.5" D Seat Ht: 17.5" COM: 1.5 yds. COL: 30 sq. ft. 16 lbs.	1,013	1,073	1,115	1,139	1,181	1,225	1,265	1,307	1,346	1,390	1,585	1,727
63114 	Guest Chair, 4-Leg Wood Base 18" W x 23.5" D x 31.5" H Seat: 18" W x 17.5" D Seat Ht: 17.5" COM: 1.5 yds. COL: 30 sq. ft. 16 lbs.	1,148	1,208	1,250	1,274	1,316	1,360	1,400	1,442	1,481	1,525	1,720	1,862

OPTIONS

- PF02 Premium Metal Leg Finish \$80
- NS05 Non-Skid Glides \$42

HADO GUEST | Designed by Qdesign

UPHOLSTERY COMBINATIONS:

- For upholstery combinations, refer to the pricing below.
- When combining two COM/COV/COL fabrics, or fabrics with the same grade, add \$85 List per unit.
- When combining three or more COM/COV/COL fabrics, or fabrics with the same grade, add \$115 List per unit.
- When combining different grades of fabric, price will be based on the highest grade specified.
- Two-tone upholstery examples and yardage requirements for the most common combinations are listed below. Additional combinations available; please contact client Services for yardage requirements and pricing.
- Note: Yardage amounts are based on fabric which is plain (i.e. non-directional) and a full 54" wide.
- Appropriate upholstery code must be included.



Code	HG1
<u>Model</u>	<u>COM Requirement</u>
63111	Back = .75 yds.
63114	Seat = 1 yd.

HADO LOUNGE | Designed by Qdesign



SPECIFICATIONS:

- Lounge and love seat models available with wood or metal legs.
- Wood legs offered in all standard and custom finishes on Ash. Please refer to standard finish card.
- For custom wood finishes, please contact client services and add one-time upcharge of \$450 List per color per order.
- Metal legs available in standard and premium finishes. See below for options.
- For custom metal finish colors, please contact client services for pricing.
- Lounge chair features 350 lb. weight capacity. Love seat and sofa feature 700 lb. weight capacity.
- 7¾" leg height clearance.
- Ships KD (knocked down). Leg assembly required.
- All dimensions are nominal.
- Refer to terms and conditions for general information regarding fabrics, finishes, warranty, freight, complete condition of sales and more.

STANDARD METAL LEG FINISH COLORS:

- #06 Charcoal Grey
- #90 Metallic Silver
- #95 Satin Black
- #97 Satin Chrome

PREMIUM METAL LEG FINISH COLORS:

- #07 Gold Shimmer
- #08 Penny
- #09 Brown Sugar
- #83 Metallic Champagne
- #94 Cotton

HADO LOUNGE | Designed by Qdesign

MINI-TAP POWER UNITS:

- Available on all lounge models.
- Dimensions: 3" W x 3" D x 1.75" H
- Black and white color options.
- 72" electrical cord (no hardware option or daisy chain feature available for this series).
- Placement is located under seat.
- Please specify front, left side or right side placement, as seated.
- For left or right side placement, unit will be centered as standard.
- For front placement, please specify left, center or right, as seated.
- UL listed.

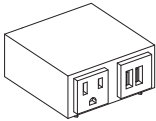

Mini-Tap 1 (MT1)

- One outlet and two USB charging ports.

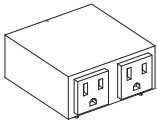

Mini-Tap 2 (MT2)

- Two outlets.

POWER BAND 1 UNIT (PB1):

- Available on all lounge models.
- One outlet and two USB charging ports.
- Dimensions: 5.75" L x 2.5" W
- Metallic silver and white finish options.
- 108" electrical cord.
- Unit will be positioned on right side arm panel, as seated, unless otherwise specified.
- UL listed.

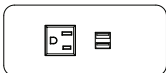





All shipments for this series will be blanket-wrapped as standard. If cartoning is required, a 5% upcharge will be added to each product. Please contact client services for additional information.

HADO LOUNGE | Designed by Qdesign

ORDERING REQUIREMENTS:

- Model number
- Leg finish
- Upholstery selection
- Options, as applicable

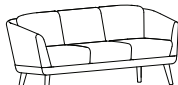
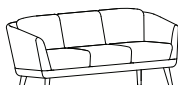
MODEL	PRODUCT SPECIFICATIONS	FABRIC GRADES										LEATHER	
		COM	A	1	2	3	4	COL 5	6	7	8	L1	L2
63224 	Lounge Chair, Wood Legs 33" W x 34.5" D x 29.5" H Seat: 22" W x 21.5" D Seat Ht: 17" COM: 4.5 yds. COL: 90 sq. ft. 67 lbs.	1,718	1,898	2,024	2,096	2,222	2,353	2,474	2,600	2,717	2,848	3,433	3,860
63224-M 	Lounge Chair, Metal Legs 33" W x 34.5" D x 29.5" H Seat: 22" W x 21.5" D Seat Ht: 17" COM: 4.5 yds. COL: 90 sq. ft. 67 lbs.	1,718	1,898	2,024	2,096	2,222	2,353	2,474	2,600	2,717	2,848	3,433	3,860
63324 	Love Seat, Wood Legs 57 W x 34.5" D x 29.5" H Seat: 22" W x 21.5" D Seat Ht: 17" COM: 8.25 yds. COL: 165 sq. ft. 95 lbs.	2,276	2,606	2,837	2,969	3,200	3,440	3,662	3,893	4,108	4,347	5,420	6,203
63324-M 	Love Seat, Metal Legs 57 W x 34.5" D x 29.5" H Seat: 22" W x 21.5" D Seat Ht: 17" COM: 8.25 yds. COL: 165 sq. ft. 95 lbs.	2,276	2,606	2,837	2,969	3,200	3,440	3,662	3,893	4,108	4,347	5,420	6,203
63424 	Sofa, Wood Legs 80" W x 34.5" D x 29.5" H Seat: 22" W x 21.5" D Seat Ht: 17" COM: 10.25 yds. COL: 205 sq. ft. 142 lbs.	3,036	3,446	3,733	3,897	4,184	4,482	4,758	5,045	5,312	5,609	6,942	7,915
63424-M 	Sofa, Metal Legs 80" W x 34.5" D x 29.5" H Seat: 22" W x 21.5" D Seat Ht: 17" COM: 10.25 yds. COL: 205 sq. ft. 142 lbs.	3,036	3,446	3,733	3,897	4,184	4,482	4,758	5,045	5,312	5,609	6,942	7,915

OPTIONS

-NS05	Non-Skid Glides	\$42
-MT1-B	Mini-Tap Power Unit (1 power, 2 USB), Black	\$494
-MT1-W	Mini-Tap Power Unit (1, power, 2 USB), White	\$494
-MT2-B	Mini-Tap Power Unit (2 power), Black	\$442
-MT2-W	Mini-Tap Power Unit (2 power), White	\$442
-PB1-S	Power Band 1 (1 power, 2 USB), Metallic Silver	\$430
-PB1-W	Power Band 1 (1 power, 2 USB), White	\$430

HADO LOUNGE | Designed by Qdesign

UPHOLSTERY COMBINATIONS:

- For upholstery combinations, refer to the pricing below.
- When combining two COM/COV/COL fabrics, or fabrics with the same grade, add \$85 List per unit.
- When combining three or more COM/COV/COL fabrics, or fabrics with the same grade, add \$115 List per unit.
- When combining different grades of fabric, price will be based on the highest grade specified.
- Two-tone upholstery examples and yardage requirements for the most common combinations are listed below. Additional combinations available; please contact client Services for yardage requirements and pricing.
- Note: Yardage amounts are based on fabric which is plain (i.e. non-directional) and a full 54" wide.
- Appropriate upholstery code must be included.

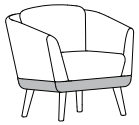

Code	HL1
<u>Model</u>	<u>COM Requirement</u>
63224	Upholstered Platform = 1 yd.
63224-M	Balance of Chair = 4.5 yds.

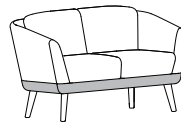

Code	HL2
<u>Model</u>	<u>COM Requirement</u>
63324	Upholstered Platform = 1.25 yds.
63324-M	Balance of Love Seat = 7.25 yds.

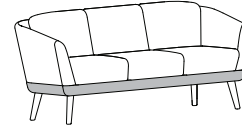

Code	HL3
<u>Model</u>	<u>COM Requirement</u>
63424	Upholstered Platform = 1.25 yds.
63424-M	Balance of Sofa = 9 yds.

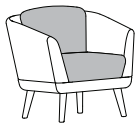

Code	HL4
<u>Model</u>	<u>COM Requirement</u>
63224	Back & Seat Cushion = 1.75 yds.
63224-M	Balance of Chair = 4 yds.

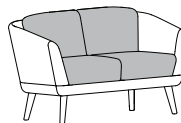

Code	HL5
<u>Model</u>	<u>COM Requirement</u>
63324	Back & Seat Cushion = 4 yds.
63324-M	Balance of Love Seat = 5 yds.

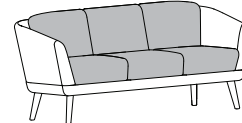

Code	HL6
<u>Model</u>	<u>COM Requirement</u>
63424	Back & Seat Cushion = 5.5 yds.
63424-M	Balance of Sofa = 5.25 yds.



Code	HL7
<u>Model</u>	<u>COM Requirement</u>
63224	Back & Seat Cushion/
63224-M	Upholstered Platform = 3.75 yds.
	Balance of Chair = 2 yds.



Code	HL8
<u>Model</u>	<u>COM Requirement</u>
63324	Back & Seat Cushion/
63324-M	Upholstered Platform = 2.5 yds.
	Balance of Love Seat = 6.75 yds.

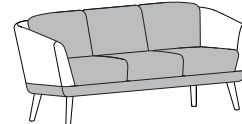

Code	HL9
<u>Model</u>	<u>COM Requirement</u>
63424	Back & Seat Cushion/
63424-M	Upholstered Platform = 2.5 yds.
	Balance of Sofa = 8.25 yds.

All shipments for this series will be blanket-wrapped as standard. If cartoning is required, a 5% upcharge will be added to each product. Please contact client services for additional information.

HADO MEETING TABLES | Designed by Qdesign



SPECIFICATIONS:

- Round, square and rectangular top shapes.
- Four top surface options: wood veneer, laminate, solid surface and Starphire® glass.
- Wood veneer tops and wood legs available in all standard and custom finishes on Ash.
- For standard wood and laminate options, please refer to standard finish card.
- For custom wood finishes, please contact client services and add one-time upcharge of \$450 List per color per order.
- For custom laminate options, add \$550 List per color per order. Pre-approval required, please contact client services.
- Glass tops are back-painted white as standard.
- Solid surface available in white only.
- For veneer or standard wood grain laminate tops, edge will match top finish color, unless specified otherwise.
- For all other finishes, edge will be exposed plywood with a clear coat finish as standard.
- Ships KD (knocked down). Leg assembly required.
- All dimensions are nominal.
- Refer to terms and conditions for general information regarding finishes, warranty, freight, complete condition of sales and more.

EDGE DETAIL:

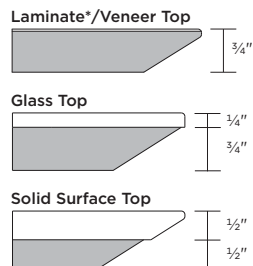

*Please note that laminate thickness is nominal and may vary.

TOP SHAPES:

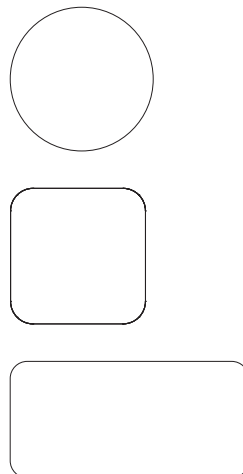



All shipments for this series will be blanket-wrapped as standard. If cartoning is required, a 5% upcharge will be added to each product. Please contact client services for additional information.

HADO MEETING TABLES | Designed by Qdesign

ORDERING REQUIREMENTS:

- Model number
- Top surface
- Top finish, if applicable
- Leg finish
- Options, as applicable

	MODEL	DESCRIPTION	veneer (-V) TOP	laminates (-L) TOP	weight
	6320-3629-()	36"D x 29"H	2,428	2,222	37 lbs.
	6320-4229-()	42"D x 29"H	2,578	2,364	46 lbs.
	6320-4829-()	48"D x 29"H	2,681	2,461	55 lbs.
	6325-363629-()	36"W x 36"D x 29"H	2,519	2,311	37 lbs.
	6325-424229-()	42"W x 42"D x 29"H	2,660	2,446	46 lbs.
	6325-484829-()	48"W x 48"D x 29"H	2,767	2,546	55 lbs.
	6325-603029-()	60"W x 30"D x 29"H	2,666	2,451	48 lbs.
	6325-723029-()	72"W x 30"D x 29"H	3,623	3,277	53 lbs.
	6325-723629-()	72"W x 36"D x 29"H	3,689	3,343	58 lbs.

OPTIONS

-NS05 Non-Skid Glides \$42

HADO OCCASIONAL TABLES | Designed by Qdesign



SPECIFICATIONS:

- Round, square and rectangular top shapes.
- Two heights: 16" and 20".
- Four top surface options: wood veneer, laminate, solid surface and Starphire® glass.
- Wood veneer tops and wood legs available in all standard and custom finishes on Ash.
- For standard wood and laminate options, please refer to standard finish card.
- For custom wood finishes, please contact client services and add one-time upcharge of \$450 List per color per order.
- For custom laminate options, add \$550 List per color per order. Pre-approval required, please contact client services.
- Glass tops are back-painted white as standard.
- Solid surface available in white only.
- For veneer or standard wood grain laminate tops, edge will match top finish color, unless specified otherwise.
- For all other finishes, edge will be exposed plywood with a clear coat finish as standard.
- Ships KD (knocked down). Leg assembly required.
- All dimensions are nominal.
- Refer to terms and conditions for general information regarding finishes, warranty, freight, complete condition of sales and more.

EDGE DETAIL:

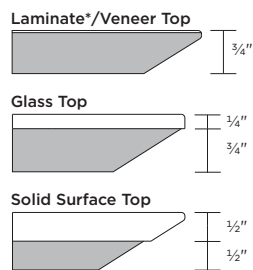

*Please note that laminate thickness is nominal and may vary.

TOP SHAPES:

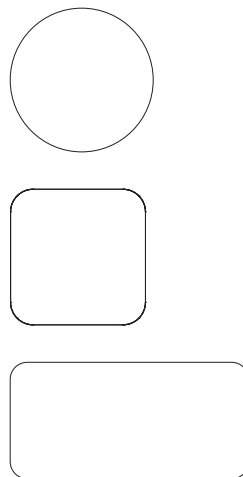



All shipments for this series will be blanket-wrapped as standard. If cartoning is required, a 5% upcharge will be added to each product. Please contact client services for additional information.

HADO OCCASIONAL TABLES | Designed by Qdesign

ORDERING REQUIREMENTS:

- Model number
- Top surface
- Top finish, if applicable
- Leg finish
- Options, as applicable

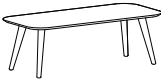
MODEL	DESCRIPTION	VENEER (-V) TOP	LAMINATE (-L) TOP	SOLID SURFACE (-SF) TOP	BACK-PAINTED GLASS TOP (-GL)	WEIGHT	
Round Top							
	6320-2116-()	21"D x 16"H	1,000	939	1,108	1,093	18 lbs.
	6320-3016-()	30"D x 16"H	1,577	1,431	1,775	1,689	26 lbs.
	6320-3616-()	36"D x 16"H	1,957	1,750	2,425	2,059	33 lbs.
	6320-4216-()	42"D x 16"H	2,044	1,831	2,750	2,191	42 lbs.
Square Top							
	6325-222216-()	22"W x 22"D x 16"H	1,017	954	1,174	1,109	18 lbs.
	6325-303016-()	30"W x 30"D x 16"H	1,594	1,447	1,791	1,704	26 lbs.
	6325-363616-()	36"W x 36"D x 16"H	1,980	1,773	2,448	2,082	33 lbs.
	6325-424216-()	42"W x 42"D x 16"H	2,070	1,857	2,776	2,217	42 lbs.
Rectangle Top							
	6325-482216-()	48"W x 22"D x 16"H	1,816	1,628	2,228	1,885	29 lbs.

OPTIONS



-NS05 Non-Skid Glides \$42

All shipments for this series will be blanket-wrapped as standard. If cartoning is required, a 5% upcharge will be added to each product. Please contact client services for additional information.

HADO OCCASIONAL TABLES | Designed by Qdesign

ORDERING REQUIREMENTS:

- Model number
- Top surface
- Top finish, if applicable
- Leg finish
- Options, as applicable

	MODEL	DESCRIPTION	VENEER (-V) TOP	LAMINATE (-L) TOP	SOLID SURFACE (-SF) TOP	BACK-PAINTED GLASS TOP (-GL)	WEIGHT
	Round Top 6320-2120-()	21"D x 20"H	1,126	1,066	1,235	1,220	19 lbs.
	Square Top 6325-222220-()	22"W x 22"D x 20"H	1,151	1,087	1,307	1,242	19 lbs.

OPTIONS

-NS05 Non-Skid Glides \$42

All shipments for this series will be cartoned as standard. If blanket-wrapped shipping is required, please contact client services for additional information.

KAMIO

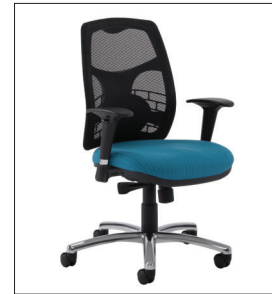

SPECIFICATIONS:

- Breathable black mesh suspension back.
- Contoured seat with perforated black fabric as standard.
- Armless and adjustable t-arm models available.
- Adjustable t-arms available in black or chrome trim detail.
- Two base options: black nylon and polished aluminum.
- Unless specified otherwise, adjustable t-arm trim will match base finish as standard.
- Adjustable t-arm features 4" arm height adjustment as standard.
- 2½" back height adjustment.
- Adjustable lumbar support standard.
- 300 lb. weight capacity.
- Ships KD (knocked down).
- All dimensions are nominal.
- Synchro-tilt mechanism. Refer to pages 13-15 for mechanism guide.
- Tilt function is disabled on stool models.
- Refer to terms and conditions for general information regarding fabrics, finishes, warranty, freight, complete condition of sales and more.

All shipments for this series will be cartoned as standard. If blanket-wrapped shipping is required, please contact client services for additional information.



KAMIO



Synchro-Tilt Mechanism

ORDERING REQUIREMENTS:

- Model number
- Base finish
- Upholstery selection
- Options, as applicable

MODEL	PRODUCT SPECIFICATIONS	BASE FINISH	FABRIC GRADES								LEATHER			
			COM	A	1	2	3	4	COL 5	6	7	8	L1	L2
2265 	Armless 20" W x 25" D x 39" - 43" H Seat: 20" W x 19" D Seat Ht: 17" - 21" Back: 19.75" W x 22" H COM: .75 yd. COL: 15 sq. ft. 31 lbs.	Black Nylon	907	937	958	970	991	1,013	1,033	1,054	1,074	1,096	1,193	1,264
		Polished Aluminum	986	1,016	1,037	1,049	1,070	1,092	1,112	1,133	1,153	1,175	1,272	1,343
2260 	Adjustable T-Arms 26" W x 25" D x 39" - 43" H Seat: 20" W x 19" D Seat Ht: 17" - 21" Back: 19.75" W x 22" H COM: .75 yd. COL: 15 sq. ft. 35 lbs.	Black Nylon	1,005	1,035	1,056	1,068	1,089	1,111	1,131	1,152	1,172	1,194	1,291	1,362
		Polished Aluminum	1,084	1,114	1,135	1,147	1,168	1,190	1,210	1,231	1,251	1,273	1,370	1,441

OPTIONS

- SS02 Seat Slider \$76
- STC02 Soft Tread Casters \$26
- SK01 Stool Kit' \$90

KENZIE OCCASIONAL TABLES | Designed by David Dahl



SPECIFICATIONS:

- Four table surface options: wood veneer, laminate, solid surface, or back-painted glass.
- Edge offered in wood veneer and laminate only.
- Two wood species available: Maple and Walnut.
- For standard wood and laminate options, please refer to standard finish card.
- For custom wood finishes, please contact client services and add one-time upcharge of \$450 List per color per order.
- For custom laminate finishes, add \$550 List per order per color. Pre-approval required, please contact client services.
- Glass tops are back-painted white as standard.
- Solid surface available in white only.
- Metal legs offered in standard and premium finishes. Please refer to listing below.
- For custom metal finish colors, please contact client services for pricing.
- All dimensions are nominal.
- Refer to terms and conditions for general information regarding finishes, warranty, freight, complete condition of sales and more.

STANDARD METAL LEG FINISH COLORS:

- #06 Charcoal Grey
- #90 Metallic Silver
- #91 Chrome
- #95 Satin Black

PREMIUM METAL LEG FINISH COLORS:



- #07 Gold Shimmer
- #08 Penny
- #09 Brown Sugar
- #83 Metallic Champagne
- #94 Cotton

All shipments for this series will be blanket-wrapped as standard. If cartoning is required, a 5% upcharge will be added to each product. Please contact client services for additional information.

KENZIE OCCASIONAL TABLES | Designed by David Dahl

ORDERING REQUIREMENTS:

- Model number
- Top surface
- Top finish, as applicable
- Edge surface
- Edge finish
- Leg finish
- Options, as applicable

	MODEL	VENEER (-V) OR LAMINATE (-L) TOP	SOLID SURFACE (-SF) TOP	BACK-PAINTED GLASS TOP (-GL)	WEIGHT
	16" Height Table				
	700-1916-()	935	1,073	1,015	15 lbs.
	700-2116-()	1,030	1,199	1,130	16 lbs.
	700-2916-()	1,317	1,661	1,450	22 lbs.
	700-3616-()	1,629	2,304	1,861	29 lbs.
	18" Height Table				
	700-1918-()	947	1,085	1,028	16 lbs.
	700-2118-()	1,045	1,214	1,143	17 lbs.
	700-2918-()	1,331	1,675	1,463	23 lbs.
	700-3618-()	1,642	2,317	1,874	30 lbs.
	20" Height Table				
	700-1920-()	961	1,099	1,042	17 lbs.
	700-2120-()	1,058	1,227	1,157	18 lbs.
	700-2920-()	1,345	1,689	1,479	24 lbs.
	700-3620-()	1,656	2,331	1,888	31 lbs.

OPTIONS

-PF02 Premium Metal Leg Finish \$80

All shipments for this series will be blanket-wrapped as standard. If cartoning is required, a 5% upcharge will be added to each product. Please contact client services for additional information.

LUCENT® GUEST | Designed by Qdesign



SPECIFICATIONS:

- Arm and armless models.
- Passive-flex back.
- ¾" steel frame.
- Three frame finish options. Please refer to listing below.
- 300 lb. weight capacity.
- All dimensions are nominal.
- Refer to terms and conditions for general information regarding fabrics, finishes, warranty, freight, complete condition of sales and more.

STANDARD METAL FRAME FINISH COLORS:



- #06 Charcoal Grey
- #90 Metallic Silver
- #91 Chrome

All shipments for this series will be blanket-wrapped as standard. If cartoning is required, a 5% upcharge will be added to each product. Please contact client services for additional information.

LUCENT® GUEST | Designed by Qdesign

ORDERING REQUIREMENTS:

- Model number
- Frame finish
- Upholstery selection

MODEL	PRODUCT SPECIFICATIONS	FABRIC GRADES										LEATHER	
		COM	A	1	2	3	4	5	6	7	8	L1	L2
2910 	Guest Chair, Arms 24" W x 22.5" D x 33" H Seat: 18.5" W x 17.5" D Seat Ht: 18" Arm Ht: 25.5" COM: 1.25 yds. COL: 25 sq. ft. 20 lbs.	1,086	1,136	1,171	1,191	1,226	1,263	1,296	1,331	1,364	1,400	1,563	1,681
2930 	Guest Chair, Armless 21.5" W x 22.5" D x 33" H Seat: 18.5" W x 17.5" D Seat Ht: 18" COM: 1.25 yds. COL: 25 sq. ft. 18 lbs.	750	800	835	855	890	927	960	995	1,028	1,064	1,227	1,345

MELINA CONFERENCE/EXECUTIVE | Licensed from Wiesner Hager - Austria



SPECIFICATIONS:

- Mid- and high back models.
- Aluminum die-cast base.
- Metal bases offered in standard and premium finishes. Please refer to listing below.
- For custom metal finish colors, please contact client services for pricing.
- 300 lb. weight capacity.
- All dimensions are nominal.
- Swivel-tilt with tilt lock mechanism. Refer to pages 13-15 for mechanism guide.
- Refer to terms and conditions for general information regarding fabrics, finishes, warranty, freight, complete condition of sales and more.

STANDARD METAL BASE FINISH COLORS:

- #06 Charcoal Grey
- #90 Metallic Silver
- #92 Polished Aluminum
- #95 Satin Black

PREMIUM METAL BASE FINISH COLORS:

- #07 Gold Shimmer
- #08 Penny
- #09 Brown Sugar
- #83 Metallic Champagne
- #94 Cotton



All shipments for this series will be blanket-wrapped as standard. If cartoning is required, a 5% upcharge will be added to each product. Please contact client services for additional information.

MELINA CONFERENCE/EXECUTIVE | Licensed from Wiesner Hager - Austria

Swivel-Tilt with Tilt Lock Mechanism

ORDERING REQUIREMENTS:

- Model number
- Base finish
- Upholstery selection
- Options, as applicable

MODEL	PRODUCT SPECIFICATIONS	FABRIC GRADES								LEATHER			
		COM	A	1	2	3	4	COL 5	6	7	8	L1	L2
5254-M 	Mid-Back Conference/Executive Chair 27.5" W x 27" D x 33" - 36" H Seat: 16" W x 18" D Seat Ht: 17" - 20" COM: 2 yds. COL: 40 sq. ft. 22 lbs.	1,241	1,321	1,377	1,409	1,465	1,523	1,577	1,633	1,685	1,743	2,003	2,193
5254-H 	High Back Conference/Executive Chair 27.5" W x 29" D x 41" - 44" H Seat: 16" W x 18" D Seat Ht: 17" - 20" COM: 2.25 yds. COL: 45 sq. ft. 25 lbs.	1,282	1,372	1,435	1,471	1,534	1,600	1,660	1,723	1,782	1,847	2,140	2,353

OPTIONS

-PF02	Premium Metal Base Finish	\$80
-STC02	Soft Tread Casters	\$26
-STLC02	Soft Tread Self-Locking Casters	\$52
-GD04	Glides	\$26
-J01	Jury Base (black only)	\$150

MELINA GUEST | Licensed from Wiesner Hager - Austria



SPECIFICATIONS:

- Four base options available: 4-leg metal, metal swivel, 4-leg wood and wood swivel.
- Swivel base models feature self-return.
- Metal bases offered in standard and premium finishes. Please refer to listing below.
- For custom metal finish colors, please contact client services for pricing.
- Wood bases offered in all standard and custom finishes on Ash. Please refer to standard finish card.
- For custom wood finishes, please contact client services and add one-time upcharge of \$450 List per color per order.
- 300 lb. weight capacity.
- All dimensions are nominal.
- Refer to terms and conditions for general information regarding fabrics, finishes, warranty, freight, complete condition of sales and more.

STANDARD METAL BASE FINISH COLORS:

- #06 Charcoal Grey
- #90 Metallic Silver
- #91 Chrome (sled base only)
- #92 Polished Aluminum (swivel base only)
- #95 Satin Black

PREMIUM METAL BASE FINISH COLORS:





- #07 Gold Shimmer
- #08 Penny
- #09 Brown Sugar
- #83 Metallic Champagne
- #94 Cotton

All shipments for this series will be blanket-wrapped as standard. If cartoning is required, a 5% upcharge will be added to each product. Please contact client services for additional information.

MELINA GUEST | Licensed from Wiesner Hager - Austria

ORDERING REQUIREMENTS:

- Model number
- Base finish
- Upholstery selection
- Options, as applicable

MODEL	PRODUCT SPECIFICATIONS	FABRIC GRADES										LEATHER	
		COM	A	1	2	3	4	COL 5	6	7	8	L1	L2
52121 	Guest Chair, 4-Leg Metal Base 27" W x 25.5" D x 33" H Seat: 16" W x 18" D Seat Ht: 18" COM: 2 yds. COL: 40 sq. ft. 22 lbs.	1,054	1,134	1,190	1,222	1,278	1,336	1,390	1,446	1,498	1,556	1,816	2,006
52123 	Guest Chair, Metal Swivel Base 27.5" W x 27.5" D x 33" H Seat: 16" W x 18" D Seat Ht: 18" COM: 2 yds. COL: 40 sq. ft. 18 lbs.	1,204	1,284	1,340	1,372	1,428	1,486	1,540	1,596	1,648	1,706	1,966	2,156
52124 	Guest Chair, 4-Leg Wood Base 27" W x 25.5" D x 33" H Seat: 16" W x 18" D Seat Ht: 18" COM: 2 yds. COL: 40 sq. ft. 17 lbs.	1,193	1,273	1,329	1,361	1,417	1,475	1,529	1,585	1,637	1,695	1,955	2,145
52127 	Guest Chair, Wood Swivel Base 29.5" W x 29.5" D x 33" H Seat: 16" W x 18" D Seat Ht: 18" COM: 2 yds. COL: 40 sq. ft. 19 lbs.	1,366	1,446	1,502	1,534	1,590	1,648	1,702	1,758	1,810	1,868	2,128	2,318

OPTIONS

-PF02	Premium Metal Base Finish	\$80
-NS04	Non-Skid Glides (4-leg wood base models only)	\$42
-NS02	Non-Skid Glides (4-leg metal base models only)	\$42
-NS02	Non-Skid Glides (metal swivel base models only)	\$42
-NS02	Non-Skid Glides (wood swivel base models only)	\$42

MELINA LOUNGE | Licensed from Wiesner Hager - Austria



SPECIFICATIONS:

- Mid- and high back models.
- Three base options available: metal swivel, 4-leg wood and wood swivel.
- Swivel base models feature self-return.
- Metal swivel base offered in standard and premium finishes. Please refer to listing below.
- For custom metal finish colors, please contact client services for pricing.
- Wood bases offered in all standard and custom finishes on Ash. Please refer to standard finish card.
- For custom wood finishes, please contact client services and add one-time upcharge of \$450 List per color per order.
- 300 lb. weight capacity.
- All dimensions are nominal.
- Refer to terms and conditions for general information regarding fabrics, finishes, warranty, freight, complete condition of sales and more.

STANDARD METAL BASE FINISH COLORS:

- #06 Charcoal Grey
- #90 Metallic Silver
- #92 Polished Aluminum
- #95 Satin Black

PREMIUM METAL BASE FINISH COLORS:

- #07 Gold Shimmer
- #08 Penny
- #09 Brown Sugar
- #83 Metallic Champagne
- #94 Cotton

All shipments for this series will be blanket-wrapped as standard. If cartoning is required, a 5% upcharge will be added to each product. Please contact client services for additional information.



MELINA LOUNGE | Licensed from Wiesner Hager - Austria



Metal swivel base model in #90 Metallic Silver and #91 Chrome finishes only

ORDERING REQUIREMENTS:

- Model number
- Base finish
- Upholstery selection
- Options, as applicable

MODEL	PRODUCT SPECIFICATIONS	FABRIC GRADES										LEATHER	
		COM	A	1	2	3	4	COL 5	6	7	8	L1	L2
52223-M 	Mid-Back Lounge Chair, Metal Swivel Base 28.5" W x 25.5" D x 31.5" H Seat: 18" W x 18" D Seat Ht: 16.75" COM: 2 yds. COL: 40 sq. ft. 25 lbs.	1,326	1,406	1,462	1,494	1,550	1,608	1,662	1,718	1,770	1,828	2,088	2,278
52224-M 	Mid-Back Lounge Chair, 4-Leg Wood Base 31.5" W x 31.5" D x 31.5" H Seat: 18" W x 18" D Seat Ht: 16.75" COM: 2 yds. COL: 40 sq. ft. 26 lbs.	1,226	1,306	1,362	1,394	1,450	1,508	1,562	1,618	1,670	1,728	1,988	2,178
52227-M 	Mid-Back Lounge Chair, Wood Swivel Base 29.5" W x 29.5" D x 31.5" H Seat: 18" W x 18" D Seat Ht: 16.75" COM: 2 yds. COL: 40 sq. ft. 27 lbs.	1,416	1,496	1,552	1,584	1,640	1,698	1,752	1,808	1,860	1,918	2,178	2,368

OPTIONS

-PF02	Premium Metal Base Finish	\$80
-NS04	Non-Skid Glides (4-leg wood base models only)	\$42
-NS02	Non-Skid Glides (metal swivel base models only)	\$42
-NS02	Non-Skid Glides (wood swivel base models only)	\$42

All shipments for this series will be blanket-wrapped as standard. If cartoning is required, a 5% upcharge will be added to each product. Please contact client services for additional information.



MELINA LOUNGE | Licensed from Wiesner Hager - Austria



Metal swivel base model in #90 Metallic Silver and #91 Chrome finishes only

ORDERING REQUIREMENTS:

- Model number
- Base finish
- Upholstery selection
- Options, as applicable

MODEL	PRODUCT SPECIFICATIONS	FABRIC GRADES								LEATHER			
		COM	A	1	2	3	4	COL 5	6	7	8	L1	L2
52223-H 	High Back Lounge Chair, Metal Swivel Base 28.5" W x 25.75" D x 39.5" H Seat: 18" W x 18" D Seat Ht: 16.75" COM: 2.25 yds. COL: 45 sq. ft. 28 lbs.	1,433	1,523	1,586	1,622	1,685	1,751	1,811	1,874	1,933	1,998	2,291	2,504
52224-H 	High Back Lounge Chair, 4-Leg Wood Base 31.5" W x 31.5" D x 39.5" H Seat: 18" W x 18" D Seat Ht: 16.75" COM: 2.25 yds. COL: 45 sq. ft. 29 lbs.	1,332	1,422	1,485	1,521	1,584	1,650	1,710	1,773	1,832	1,897	2,190	2,403
52227-H 	High Back Lounge Chair, Wood Swivel Base 29.5" W x 29.5" D x 39.5" H Seat: 18" W x 18" D Seat Ht: 16.75" COM: 2.25 yds. COL: 45 sq. ft. 36 lbs.	1,498	1,588	1,651	1,687	1,750	1,816	1,876	1,939	1,998	2,063	2,356	2,569

OPTIONS

-PF02	Premium Metal Base Finish	\$80
-NS04	Non-Skid Glides (4-leg wood base models only)	\$42
-NS02	Non-Skid Glides (metal swivel base models only)	\$42
-NS02	Non-Skid Glides (wood swivel base models only)	\$42

MELINA COLLECTION | Licensed from Wiesner Hager - Austria

UPHOLSTERY COMBINATIONS:

- For upholstery combinations, refer to the pricing below.
- When combining two COM/COV/COL fabrics, or fabrics with the same grade, add \$85 List per unit.
- When combining three or more COM/COV/COL fabrics, or fabrics with the same grade, add \$115 List per unit.
- When combining different grades of fabric, price will be based on the highest grade specified.
- Two-tone upholstery examples and yardage requirements for the most common combinations are listed below. Additional combinations available; please contact client Services for yardage requirements and pricing.
- Note: Yardage amounts are based on fabric which is plain (i.e. non-directional) and a full 54" wide.
- Appropriate upholstery code must be included.



Code	ML1
<u>Model</u>	<u>COM Requirement</u>
5254-M	Seat Cushion = 1 yd.
52121	Balance of Chair = 1.5 yds.
52123	
52124	
52127	
52223-M	
52224-M	
52227-M	



Code	ML2
<u>Model</u>	<u>COM Requirement</u>
5254-H	Seat Cushion = 1 yd.
52223-H	Balance of Chair = 1.75 yds.
52224-H	
52227-H	

MELINA MEETING TABLES | Licensed from Wiesner Hager - Austria



SPECIFICATIONS:

- Round and square top shapes.
- 29" and 42" heights.
- Four table surface options: wood veneer, laminate, solid surface or Starphire® glass.
- Wood veneer available in all standard and custom finishes on Ash.
- For standard wood and laminate options, please refer to standard finish card.
- For custom wood finishes, please contact client services and add one-time upcharge of \$450 List per color per order.
- For custom laminate options, add \$550 List per color per order. Pre-approval required, please contact client services.
- Solid surface available in white only.
- Glass tops are back-painted white as standard.
- For veneer or standard wood grain laminate tops, edge will match top finish color, unless specified otherwise.
- For all other finishes, edge will be exposed plywood with a clear coat finish as standard.
- Column and base offered in standard and premium metal finishes. Please refer to listing below.
- All dimensions are nominal.
- Refer to terms and conditions for general information regarding finishes, warranty, freight, complete condition of sales and more.

STANDARD METAL COLUMN/BASE FINISH COLORS:

- #06 Charcoal Grey
- #90 Metallic Silver
- #92 Polished Aluminum
- #95 Satin Black

PREMIUM METAL COLUMN/BASE FINISH COLORS:

- #07 Gold Shimmer
- #08 Penny
- #09 Brown Sugar
- #83 Metallic Champagne
- #94 Cotton

POWER NODE UNIT:

- Available on tables with veneer, laminate and solid surface tops. Not available on glass top tables.
- Dimensions: 3³/₈" Dia.
- Satin nickel finish.
- 72" electrical cord.
- UL listed.
- Unless specified otherwise, unit will be positioned in center of table-top.

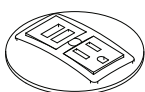

Power Node (PN):

- Two outlets and two USB charging ports.

EDGE DETAIL

Laminate*/Veneer Top



Exposed Plywood Edge

Glass Top



1/2" Exposed Plywood Substrate

Solid Surface Top



1/2" Plywood Substrate

*Please note that laminate thickness is nominal and may vary.

All shipments for this series will be blanket-wrapped as standard. If cartoning is required, a 5% upcharge will be added to each product. Please contact client services for additional information.

MELINA MEETING TABLES | Licensed from Wiesner Hager - Austria



Laminate and solid surface tops with #90 Metallic Silver and #92 Polished Aluminum base finishes only

ORDERING REQUIREMENTS:

- Model number
- Top surface
- Top finish, as applicable
- Column/base finish
- Options, as applicable

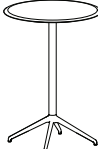
MODEL	VENEER (-V)	LAMINATE (-L)	SOLID SURFACE (-SF)	BACK-PAINTED GLASS (-GL)	WEIGHT
 <p>Round Top, 29" Height 5220-3029-() 5220-3629-() 5220-4229-()</p>	1,618	1,567	1,911	1,837	38 lbs.
	1,985	1,875	2,550	2,244	48 lbs.
	2,066	1,957	2,876	2,336	59 lbs.
 <p>Round Top, 42" Height 5220-3042-() 5220-3642-() 5220-4242-()</p>	1,723	1,680	2,024	1,951	38 lbs.
	2,090	1,988	2,663	2,363	48 lbs.
	2,171	2,071	2,990	2,453	59 lbs.

OPTIONS

- PF02 Premium Metal Base Finish \$80
- PN Power Node \$580
(Not available on models with glass tops)

All shipments for this series will be blanket-wrapped as standard. If cartoning is required, a 5% upcharge will be added to each product. Please contact client services for additional information.



MELINA MEETING TABLES | Licensed from Wiesner Hager - Austria



Laminate and solid surface tops with #90 Metallic Silver and #92 Polished Aluminum base finishes only

ORDERING REQUIREMENTS:

- Model number
- Top surface
- Top finish, as applicable
- Column/base finish
- Options, as applicable

MODEL	VENEER (-V)	LAMINATE (-L)	SOLID SURFACE (-SF)	BACK-PAINTED GLASS (-GL)	WEIGHT
 <p>Square Top, 29" Height 5225-303029-() 5225-363629-() 5225-424229-()</p>	1,648	1,568	1,912	1,863	38 lbs.
	2,016	1,877	2,552	2,279	48 lbs.
	2,094	1,961	2,880	2,367	59 lbs.
 <p>Square Top, 42" Height 5225-303042-() 5225-363642-() 5225-424242-()</p>	1,753	1,681	2,025	1,981	42 lbs.
	2,120	1,990	2,665	2,396	52 lbs.
	2,200	2,074	2,993	2,486	63 lbs.

OPTIONS

- PF02 Premium Metal Base Finish \$80
- PN Power Node \$580
(Not available on models with glass tops)

MELINA OCCASIONAL TABLES | Licensed from Wiesner Hager - Austria



SPECIFICATIONS:

- Round and square top shapes.
- 16" height.
- Four table surface options: wood veneer, laminate, solid surface or Starphire® glass.
- Wood veneer available in all standard and custom finishes on Ash.
- For standard wood and laminate options, please refer to standard finish card.
- For custom wood finishes, please contact client services and add one-time upcharge of \$450 List per color per order.
- For custom laminate options, add \$550 List per color per order. Pre-approval required, please contact client services.
- Solid surface available in white only.
- Glass tops are back-painted white as standard.
- For veneer or standard wood grain laminate tops, edge will match top finish color, unless specified otherwise.
- For all other finishes, edge will be exposed plywood with a clear coat finish as standard.
- Column and base offered in standard and premium metal finishes. Please refer to listing below.
- All dimensions are nominal.
- Refer to terms and conditions for general information regarding finishes, warranty, freight, complete condition of sales and more.

STANDARD METAL COLUMN/BASE FINISH COLORS:

- #06 Charcoal Grey
- #90 Metallic Silver
- #92 Polished Aluminum
- #95 Satin Black

PREMIUM METAL COLUMN/BASE FINISH COLORS:

- #07 Gold Shimmer
- #08 Penny
- #09 Brown Sugar
- #83 Metallic Champagne
- #94 Cotton

POWER NODE UNIT:

- Available on tables with veneer, laminate and solid surface tops. Not available on glass top tables.
- Dimensions: 3³/₈" Dia.
- Satin nickel finish.
- 72" electrical cord.
- UL listed.
- Unless specified otherwise, unit will be positioned in center of table-top.

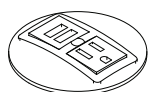

Power Node (PN):

- Two outlets and two USB charging ports.

EDGE DETAIL

Laminate*/Veneer Top



Exposed Plywood Edge

Glass Top



1/8" Exposed Plywood Substrate

Solid Surface Top



1/2" Plywood Substrate

*Please note that laminate thickness is nominal and may vary.

All shipments for this series will be blanket-wrapped as standard. If cartoning is required, a 5% upcharge will be added to each product. Please contact client services for additional information.



MELINA OCCASIONAL TABLES | Licensed from Wiesner Hager - Austria



Laminate and solid surface tops with #90 Metallic Silver and #92 Polished Aluminum base finishes only

ORDERING REQUIREMENTS:

- Model number
- Top surface
- Top finish, as applicable
- Column/base finish
- Options, as applicable

MODEL	veneer (-V)	laminate (-L)	solid surface (-SF)	back-painted glass (-GL)	weight
 Round Top, 16" Height 5220-3016-() 5220-3616-() 5220-4216-()	1,468	1,402	1,746	1,673	34 lbs.
	1,836	1,711	2,386	2,075	44 lbs.
	1,915	1,793	2,712	2,172	55 lbs.
 Square Top, 16" Height 5225-303016-() 5225-363616-() 5225-424216-()	1,499	1,403	1,747	1,695	34 lbs.
	1,867	1,713	2,388	2,110	44 lbs.
	1,945	1,796	2,715	2,199	55 lbs.

OPTIONS

- PF02 Premium Metal Base Finish \$80
- PN Power Node \$580
(Not available on models with glass tops)

All shipments for this series will be cartoned as standard. If blanket-wrapped shipping is required, please contact client services for additional information.

MEMENTO EXECUTIVE



SPECIFICATIONS:

- Fully upholstered seat and back.
- Channel back stitching also offered.
- Armless, adjustable t-arm and polished aluminum cantilever arm models.
- Polished aluminum cantilever arm features black soft-touch arm cap.
- Optional fully polished aluminum cantilever arm without arm cap also available.
- Adjustable t-arms available with black or chrome trim detail.
- Black adjustable t-arm finish is standard unless specified otherwise.
- Adjustable t-arm features 4" arm height adjustment as standard.
- Fixed back height.
- Memory foam standard on seat.
- Swivel-tilt with tilt lock, synchro-tilt and synchro knee-tilt mechanisms available. Refer to pages 13-15 for mechanism guide.
- Two base options: black nylon and polished aluminum.
- 300 lb. weight capacity.
- Ships KD (knocked down).
- All dimensions are nominal.
- Refer to terms and conditions for general information regarding fabrics, finishes, warranty, freight, complete condition of sales and more.

All shipments for this series will be cartoned as standard. If blanket-wrapped shipping is required, please contact client services for additional information.



MEMENTO EXECUTIVE



Swivel-Tilt with Tilt Lock Mechanism

ORDERING REQUIREMENTS:

- Model number
- Arm finish, if applicable
- Base finish
- Upholstery selection
- Options, as applicable

MODEL	PRODUCT SPECIFICATIONS	BASE FINISH	FABRIC GRADES								LEATHER			
			COM	A	1	2	3	4	COL 5	6	7	8	L1	L2
5551-U 	Upholstered Back, Armless 20" W x 22" D x 39"- 44" H Seat: 20.5" W x 18.5" D Seat Ht: 17" - 22" Back: 19" W x 24" H COM: 1.5 yds. COL: 30 sq. ft. 32 lbs.	Black Nylon	839	899	941	965	1,007	1,051	1,091	1,133	1,172	1,216	1,411	1,553
		Polished Aluminum	918	978	1,020	1,044	1,086	1,130	1,170	1,212	1,251	1,295	1,490	1,632
5553-U 	Upholstered Back, Adjustable T-Arms 27" W x 22" D x 39"- 44" H Seat: 20.5" W x 18.5" D Seat Ht: 17" - 22" Back: 19" W x 24" H COM: 1.5 yds. COL: 30 sq. ft. 38 lbs.	Black Nylon	941	1,001	1,043	1,067	1,109	1,153	1,193	1,235	1,274	1,318	1,513	1,655
		Polished Aluminum	1,020	1,080	1,122	1,146	1,188	1,232	1,272	1,314	1,353	1,397	1,592	1,734
5554-U 	Upholstered Back, Polished Aluminum Cantilever Arms 24.5" W x 22" D x 39"- 44" H Seat: 20.5" W x 18.5" D Seat Ht: 17" - 22" Back: 19" W x 24" H COM: 1.5 yds. COL: 30 sq. ft. 38 lbs.	Black Nylon	932	992	1,034	1,058	1,100	1,144	1,184	1,226	1,265	1,309	1,504	1,646
		Polished Aluminum	1,011	1,071	1,113	1,137	1,179	1,223	1,263	1,305	1,344	1,388	1,583	1,725

Note:
For two-tone upholstery, COM requirements are .75 yd. for seat and 1 yd. for back.

OPTIONS

-FP01	Fully Polished Arms (no arm cap) (5554-U model only)	\$60	-STLC02	Soft Tread Self-Locking Casters	\$52
-WA01	Width Adjustable Arms	\$30	-GD04	Glides	\$26
-PV01	Pivot Arms	\$55	-SK01	Stool Kit ¹	\$90
-STC02	Soft Tread Casters	\$26	-J01	Jury Base (black only)	\$150

¹ Stool models feature non-tilting mechanism.

All shipments for this series will be cartoned as standard. If blanket-wrapped shipping is required, please contact client services for additional information.



MEMENTO EXECUTIVE



Synchro Knee-Tilt Mechanism

ORDERING REQUIREMENTS:

- Model number
- Arm finish, if applicable
- Base finish
- Upholstery selection
- Options, as applicable

MODEL	PRODUCT SPECIFICATIONS	BASE FINISH	FABRIC GRADES								LEATHER			
			COM	A	1	2	3	4	COL 5	6	7	8	L1	L2
5581-U 	Upholstered Back, Armless 20" W x 22" D x 39"- 44" H Seat: 20.5" W x 18.5" D Seat Ht: 17" - 22" Back: 19" W x 24" H COM: 1.5 yds. COL: 30 sq. ft. 34 lbs.	Black Nylon	992	1,052	1,094	1,118	1,160	1,204	1,244	1,286	1,325	1,369	1,564	1,706
		Polished Aluminum	1,071	1,131	1,173	1,197	1,239	1,283	1,323	1,365	1,404	1,448	1,643	1,785
5583-U 	Upholstered Back, Adjustable T-Arms 27" W x 22" D x 39"- 44" H Seat: 20.5" W x 18.5" D Seat Ht: 17" - 22" Back: 19" W x 24" H COM: 1.5 yds. COL: 30 sq. ft. 40 lbs.	Black Nylon	1,108	1,168	1,210	1,234	1,276	1,320	1,360	1,402	1,441	1,485	1,680	1,822
		Polished Aluminum	1,187	1,247	1,289	1,313	1,355	1,399	1,439	1,481	1,520	1,564	1,759	1,901
5584-U 	Upholstered Back, Polished Aluminum Cantilever Arms 24.5" W x 22" D x 39"- 44" H Seat: 20.5" W x 18.5" D Seat Ht: 17" - 22" Back: 19" W x 24" H COM: 1.5 yds. COL: 30 sq. ft. 40 lbs.	Black Nylon	1,119	1,179	1,221	1,245	1,287	1,331	1,371	1,413	1,452	1,496	1,691	1,833
		Polished Aluminum	1,198	1,258	1,300	1,324	1,366	1,410	1,450	1,492	1,531	1,575	1,770	1,912

Note:
For two-tone upholstery, COM requirements are .75 yd. for seat and 1 yd. for back.

OPTIONS

-FP01	Fully Polished Arms (no arm cap) (5584-U model only)	\$60	-STLC02	Soft Tread Self-Locking Casters	\$52
-WA01	Width Adjustable Arms	\$30	-GD04	Glides	\$26
-PV01	Pivot Arms	\$55	-J01	Jury Base (black only)	\$150
-STC02	Soft Tread Casters	\$26			



All shipments for this series will be cartoned as standard. If blanket-wrapped shipping is required, please contact client services for additional information.

MEMENTO EXECUTIVE

Synchro-Tilt Mechanism

ORDERING REQUIREMENTS:

- Model number
- Arm finish, if applicable
- Base finish
- Upholstery selection
- Options, as applicable

MODEL	PRODUCT SPECIFICATIONS	BASE FINISH	FABRIC GRADES								LEATHER			
			COM	A	1	2	3	4	COL 5	6	7	8	L1	L2
5591-U 	Upholstered Back, Armless 20" W x 22" D x 39"- 44" H Seat: 20.5" W x 18.5" D Seat Ht: 17" - 22" Back: 19" W x 24" H COM: 1.5 yds. COL: 30 sq. ft. 32 lbs.	Black Nylon	887	947	989	1,013	1,055	1,099	1,139	1,181	1,220	1,264	1,459	1,601
		Polished Aluminum	966	1,026	1,068	1,092	1,134	1,178	1,218	1,260	1,299	1,343	1,538	1,680
5593-U 	Upholstered Back, Adjustable T-Arms 27" W x 22" D x 39"- 44" H Seat: 20.5" W x 18.5" D Seat Ht: 17" - 22" Back: 19" W x 24" H COM: 1.5 yds. COL: 30 sq. ft. 38 lbs.	Black Nylon	990	1,050	1,092	1,116	1,158	1,202	1,242	1,284	1,323	1,367	1,562	1,704
		Polished Aluminum	1,069	1,129	1,171	1,195	1,237	1,281	1,321	1,363	1,402	1,446	1,641	1,783
5594-U 	Upholstered Back, Polished Aluminum Cantilever Arms 24.5" W x 22" D x 39"- 44" H Seat: 20.5" W x 18.5" D Seat Ht: 17" - 22" Back: 19" W x 24" H COM: 1.5 yds. COL: 30 sq. ft. 38 lbs.	Black Nylon	1,010	1,070	1,112	1,136	1,178	1,222	1,262	1,304	1,343	1,387	1,582	1,724
		Polished Aluminum	1,089	1,149	1,191	1,215	1,257	1,301	1,341	1,383	1,422	1,466	1,661	1,803

Note:
 For two-tone upholstery, COM requirements are .75 yd. for seat and 1 yd. for back.

OPTIONS

-FP01	Fully Polished Arms (no arm cap) (5594-U model only)	\$60	-STC02	Soft Tread Casters	\$26
-WA01	Width Adjustable Arms	\$30	-STLC02	Soft Tread Self-Locking Casters	\$52
-PV01	Pivot Arms	\$55	-GD04	Glides	\$26
-SS02	Seat Slider	\$76	-J01	Jury Base (black only)	\$150



All shipments for this series will be cartoned as standard. If blanket-wrapped shipping is required, please contact client services for additional information.

MEMENTO EXECUTIVE

Swivel-Tilt with Tilt Lock Mechanism

ORDERING REQUIREMENTS:

- Model number
- Arm finish, if applicable
- Base finish
- Upholstery selection
- Options, as applicable

MODEL	PRODUCT SPECIFICATIONS	BASE FINISH	FABRIC GRADES								LEATHER			
			COM	A	1	2	3	4	COL 5	6	7	8	L1	L2
5551-C 	Upholstered Channel Back, Armless 20" W x 22" D x 39"- 44" H Seat: 20.5" W x 18.5" D Seat Ht: 17" - 22" Back: 19" W x 24" H COM: 1.5 yds. COL: 30 sq. ft. 32 lbs.	Black Nylon	945	1,005	1,047	1,071	1,113	1,157	1,197	1,239	1,278	1,322	1,517	1,659
		Polished Aluminum	1,024	1,084	1,126	1,150	1,192	1,236	1,276	1,318	1,357	1,401	1,596	1,738
5553-C 	Upholstered Channel Back, Adjustable T-Arms 27" W x 22" D x 39"- 44" H Seat: 20.5" W x 18.5" D Seat Ht: 17" - 22" Back: 19" W x 24" H COM: 1.5 yds. COL: 30 sq. ft. 38 lbs.	Black Nylon	1,036	1,096	1,138	1,162	1,204	1,248	1,288	1,330	1,369	1,413	1,608	1,750
		Polished Aluminum	1,115	1,175	1,217	1,241	1,283	1,327	1,367	1,409	1,448	1,492	1,687	1,829
5554-C 	Upholstered Channel Back, Polished Aluminum Cantilever Arms 24.5" W x 22" D x 39"- 44" H Seat: 20.5" W x 18.5" D Seat Ht: 17" - 22" Back: 19" W x 24" H COM: 1.5 yds. COL: 30 sq. ft. 38 lbs.	Black Nylon	1,036	1,096	1,138	1,162	1,204	1,248	1,288	1,330	1,369	1,413	1,608	1,750
		Polished Aluminum	1,115	1,175	1,217	1,241	1,283	1,327	1,367	1,409	1,448	1,492	1,687	1,829

Note:
For two-tone upholstery, COM requirements are .75 yd. for seat and 1 yd. for back.

OPTIONS

-FP01	Fully Polished Arms (no arm cap) (5554-C model only)	\$60	-GD04	Glides	\$26
-WA01	Width Adjustable Arms	\$30	-SK01	Stool Kit ¹	\$90
-PV01	Pivot Arms	\$55	-J01	Jury Base (black only)	\$150
-STC02	Soft Tread Casters	\$26			
-STLC02	Soft Tread Self-Locking Casters	\$52			

¹ Stool models feature non-tilting mechanism.



All shipments for this series will be cartoned as standard. If blanket-wrapped shipping is required, please contact client services for additional information.

MEMENTO EXECUTIVE

Synchro Knee-Tilt Mechanism

ORDERING REQUIREMENTS:

- Model number
- Arm finish, if applicable
- Base finish
- Upholstery selection
- Options, as applicable

MODEL	PRODUCT SPECIFICATIONS	BASE FINISH	FABRIC GRADES								LEATHER			
			COM	A	1	2	3	4	COL 5	6	7	8	L1	L2
5581-C 	Upholstered Channel Back, Armless 20" W x 22" D x 39"- 44" H Seat: 20.5" W x 18.5" D Seat Ht: 17" - 22" Back: 19" W x 24" H COM: 1.5 yds. COL: 30 sq. ft. 34 lbs.	Black Nylon	1,106	1,166	1,208	1,232	1,274	1,318	1,358	1,400	1,439	1,483	1,678	1,820
		Polished Aluminum	1,185	1,245	1,287	1,311	1,353	1,397	1,437	1,479	1,518	1,562	1,757	1,899
5583-C 	Upholstered Channel Back, Adjustable T-Arms 27" W x 22" D x 39"- 44" H Seat: 20.5" W x 18.5" D Seat Ht: 17" - 22" Back: 19" W x 24" H COM: 1.5 yds. COL: 30 sq. ft. 40 lbs.	Black Nylon	1,201	1,261	1,303	1,327	1,369	1,413	1,453	1,495	1,534	1,578	1,773	1,915
		Polished Aluminum	1,280	1,340	1,382	1,406	1,448	1,492	1,532	1,574	1,613	1,657	1,852	1,994
5584-C 	Upholstered Channel Back, Polished Aluminum Cantilever Arms 24.5" W x 22" D x 39"- 44" H Seat: 20.5" W x 18.5" D Seat Ht: 17" - 22" Back: 19" W x 24" H COM: 1.5 yds. COL: 30 sq. ft. 40 lbs.	Black Nylon	1,201	1,261	1,303	1,327	1,369	1,413	1,453	1,495	1,534	1,578	1,773	1,915
		Polished Aluminum	1,280	1,340	1,382	1,406	1,448	1,492	1,532	1,574	1,613	1,657	1,852	1,994

Note:
For two-tone upholstery, COM requirements are .75 yd. for seat and 1 yd. for back.

OPTIONS

-FP01	Fully Polished Arms (no arm cap) (5584-C model only)	\$60	-STC02	Soft Tread Casters	\$26
-WA01	Width Adjustable Arms	\$30	-STLC02	Soft Tread Self-Locking Casters	\$52
-PV01	Pivot Arms	\$55	-GD04	Glides	\$26
			-J01	Jury Base (black only)	\$150



All shipments for this series will be cartoned as standard. If blanket-wrapped shipping is required, please contact client services for additional information.

MEMENTO EXECUTIVE

Synchro-Tilt Mechanism

ORDERING REQUIREMENTS:

- Model number
- Arm finish, if applicable
- Base finish
- Upholstery selection
- Options, as applicable

MODEL	PRODUCT SPECIFICATIONS	BASE FINISH	FABRIC GRADES								LEATHER			
			COM	A	1	2	3	4	COL 5	6	7	8	L1	L2
5591-C 	Upholstered Channel Back, Armless 20" W x 22" D x 39"- 44" H Seat: 20.5" W x 18.5" D Seat Ht: 17" - 22" Back: 19" W x 24" H COM: 1.5 yds. COL: 30 sq. ft. 32 lbs.	Black Nylon	983	1,043	1,085	1,109	1,151	1,195	1,235	1,277	1,316	1,360	1,555	1,697
		Polished Aluminum	1,062	1,122	1,164	1,188	1,230	1,274	1,314	1,356	1,395	1,439	1,634	1,776
5593-C 	Upholstered Channel Back, Adjustable T-Arms 27" W x 22" D x 39"- 44" H Seat: 20.5" W x 18.5" D Seat Ht: 17" - 22" Back: 19" W x 24" H COM: 1.5 yds. COL: 30 sq. ft. 38 lbs.	Black Nylon	1,076	1,136	1,178	1,202	1,244	1,288	1,328	1,370	1,409	1,453	1,648	1,790
		Polished Aluminum	1,155	1,215	1,257	1,281	1,323	1,367	1,407	1,449	1,488	1,532	1,727	1,869
5594-C 	Upholstered Channel Back, Polished Aluminum Cantilever Arms 24.5" W x 22" D x 39"- 44" H Seat: 20.5" W x 18.5" D Seat Ht: 17" - 22" Back: 19" W x 24" H COM: 1.5 yds. COL: 30 sq. ft. 38 lbs.	Black Nylon	1,076	1,136	1,178	1,202	1,244	1,288	1,328	1,370	1,409	1,453	1,648	1,790
		Polished Aluminum	1,155	1,215	1,257	1,281	1,323	1,367	1,407	1,449	1,488	1,532	1,727	1,869

Note:
For two-tone upholstery, COM requirements are .75 yd. for seat and 1 yd. for back.

OPTIONS

-FP01	Fully Polished Arms (no arm cap) (5594-C model only)	\$60	-STC02	Soft Tread Casters	\$26
-SS02	Seat Slider	\$76	-STLC02	Soft Tread Self-Locking Casters	\$52
-WA01	Width Adjustable Arms	\$30	-GD04	Glides	\$26
-PV01	Pivot Arms	\$55	-J01	Jury Base (black only)	\$150

MEMENTO TASK



SPECIFICATIONS:

- Fully upholstered back and seat.
- Channel back stitching also offered.
- Armless, adjustable t-arm and polished aluminum cantilever arm models.
- Polished aluminum cantilever arm features black soft-touch arm cap.
- Adjustable t-arms available with black or chrome trim detail.
- Unless specified otherwise, t-arm trim will match base finish as standard.
- Adjustable t-arm features 4" arm height adjustment as standard.
- 2½" back height adjustment.
- Memory foam standard on seat.
- Swivel-tilt with tilt lock, task intensive and synchro-tilt mechanism. Refer to pages 13-15 for mechanism guide.
- Stool models feature non-tilting mechanism.
- Two base options: black nylon and polished aluminum.
- 300 lb. weight capacity.
- Ships KD (knocked down).
- All dimensions are nominal.
- Refer to terms and conditions for general information regarding fabrics, finishes, warranty, freight, complete condition of sales and more.



All shipments for this series will be cartoned as standard. If blanket-wrapped shipping is required, please contact client services for additional information.

MEMENTO TASK

Task Intensive Mechanism

ORDERING REQUIREMENTS:

- Model number
- Arm finish, if applicable
- Base finish
- Upholstery selection
- Options, as applicable

MODEL	PRODUCT SPECIFICATIONS	BASE FINISH	FABRIC GRADES								LEATHER			
			COM	A	1	2	3	4	COL 5	6	7	8	L1	L2
5641-U 	Upholstered Back, Armless 20" W x 22" D x 34.5"- 39.5" H Seat: 20.5" W x 18" D Seat Ht: 17" - 22" Back: 18.5" W x 20" H COM: 1.5 yds. COL: 30 sq. ft. 44 lbs.	Black Nylon	902	962	1,004	1,028	1,070	1,114	1,154	1,196	1,235	1,279	1,474	1,616
		Polished Aluminum	981	1,041	1,083	1,107	1,149	1,193	1,233	1,275	1,314	1,358	1,553	1,695
5643-U 	Upholstered Back, Adjustable T-Arms 27" W x 22" D x 34.5"- 39.5" H Seat: 20.5" W x 18" D Seat Ht: 17" - 22" Back: 18.5" W x 20" H COM: 1.5 yds. COL: 30 sq. ft. 50 lbs.	Black Nylon	997	1,057	1,099	1,123	1,165	1,209	1,249	1,291	1,330	1,374	1,569	1,711
		Polished Aluminum	1,076	1,136	1,178	1,202	1,244	1,288	1,328	1,370	1,409	1,453	1,648	1,790
5644-U 	Upholstered Back, Polished Aluminum Cantilever Arms 24.5" W x 22" D x 34.5"- 39.5" H Seat: 20.5" W x 18" D Seat Ht: 17" - 22" Back: 18.5" W x 20" H COM: 1.5 yds. COL: 30 sq. ft. 50 lbs.	Black Nylon	1,017	1,077	1,119	1,143	1,185	1,229	1,269	1,311	1,350	1,394	1,589	1,731
		Polished Aluminum	1,096	1,156	1,198	1,222	1,264	1,308	1,348	1,390	1,429	1,473	1,668	1,810

Note:
For two-tone upholstery, COM requirements are .75 yd. for seat and 1 yd. for back.

OPTIONS			
-FP01	Fully Polished Arms (no arm cap) (5644-U model only)	\$60	
-SS03	Seat Slider	\$76	
-WA01	Width Adjustable Arms	\$30	
-PV01	Pivot Arms	\$55	
			-STC02 Soft Tread Casters \$26
			-STLC02 Soft Tread Self-Locking Casters \$52
			-GD04 Glides \$26
			-J01 Jury Base (black only) \$150

All shipments for this series will be cartoned as standard. If blanket-wrapped shipping is required, please contact client services for additional information.



MEMENTO TASK



Swivel-Tilt with Tilt Lock Mechanism

ORDERING REQUIREMENTS:

- Model number
- Arm finish, if applicable
- Base finish
- Upholstery selection
- Options, as applicable

MODEL	PRODUCT SPECIFICATIONS	BASE FINISH	FABRIC GRADES								LEATHER			
			COM	A	1	2	3	4	COL 5	6	7	8	L1	L2
5651-U 	Upholstered Back, Armless 20" W x 22" D x 34.5"- 39.5" H Seat: 20.5" W x 18" D Seat Ht: 17" - 22" Back: 18.5" W x 20" H COM: 1.5 yds. COL: 30 sq. ft. 36 lbs.	Black Nylon	843	903	945	969	1,011	1,055	1,095	1,137	1,176	1,220	1,415	1,557
		Polished Aluminum	922	982	1,024	1,048	1,090	1,134	1,174	1,216	1,255	1,299	1,494	1,636
5653-U 	Upholstered Back, Adjustable T-Arms 27" W x 22" D x 34.5"- 39.5" H Seat: 20.5" W x 18" D Seat Ht: 17" - 22" Back: 18.5" W x 20" H COM: 1.5 yds. COL: 30 sq. ft. 42 lbs.	Black Nylon	949	1,009	1,051	1,075	1,117	1,161	1,201	1,243	1,282	1,326	1,521	1,663
		Polished Aluminum	1,028	1,088	1,130	1,154	1,196	1,240	1,280	1,322	1,361	1,405	1,600	1,742
5654-U 	Upholstered Back, Polished Aluminum Cantilever Arms 24.5" W x 22" D x 34.5"- 39.5" H Seat: 20.5" W x 18" D Seat Ht: 17" - 22" Back: 18.5" W x 20" H COM: 1.5 yds. COL: 30 sq. ft. 42 lbs.	Black Nylon	949	1,009	1,051	1,075	1,117	1,161	1,201	1,243	1,282	1,326	1,521	1,663
		Polished Aluminum	1,028	1,088	1,130	1,154	1,196	1,240	1,280	1,322	1,361	1,405	1,600	1,742

Note:
 For two-tone upholstery, COM requirements are .75 yd. for seat and 1 yd. for back.

OPTIONS

-FP01	Fully Polished Arms (no arm cap) (5654-U model only)	\$60	-STLC02	Soft Tread Self-Locking Casters	\$52
-SS02	Seat Slider	\$76	-GD04	Glides	\$26
-WA01	Width Adjustable Arms	\$30	-SK01	Stool Kit*	\$90
-PV01	Pivot Arms	\$55	-J01	Jury Base (black only)	\$150
-STC02	Soft Tread Casters	\$26			

* Stool models feature non-tilting mechanism.



All shipments for this series will be cartoned as standard. If blanket-wrapped shipping is required, please contact client services for additional information.

MEMENTO TASK

Synchro-Tilt Mechanism

ORDERING REQUIREMENTS:

- Model number
- Arm finish, if applicable
- Base finish
- Upholstery selection
- Options, as applicable

MODEL	PRODUCT SPECIFICATIONS	BASE FINISH	FABRIC GRADES								LEATHER			
			COM	A	1	2	3	4	COL 5	6	7	8	L1	L2
5691-U 	Upholstered Back, Armless 20" W x 22" D x 34.5"- 39.5" H Seat: 20.5" W x 18" D Seat Ht: 17" - 22" Back: 18.5" W x 20" H COM: 1.5 yds. COL: 30 sq. ft. 37 lbs.	Black Nylon	885	945	987	1,011	1,053	1,097	1,137	1,179	1,218	1,262	1,457	1,599
		Polished Aluminum	964	1,024	1,066	1,090	1,132	1,176	1,216	1,258	1,297	1,341	1,536	1,678
5693-U 	Upholstered Back, Adjustable T-Arms 27" W x 22" D x 34.5"- 39.5" H Seat: 20.5" W x 18" D Seat Ht: 17" - 22" Back: 18.5" W x 20" H COM: 1.5 yds. COL: 30 sq. ft. 43 lbs.	Black Nylon	991	1,051	1,093	1,117	1,159	1,203	1,243	1,285	1,324	1,368	1,563	1,705
		Polished Aluminum	1,070	1,130	1,172	1,196	1,238	1,282	1,322	1,364	1,403	1,447	1,642	1,784
5694-U 	Upholstered Back, Polished Aluminum Cantilever Arms 24.5" W x 22" D x 34.5"- 39.5" H Seat: 20.5" W x 18" D Seat Ht: 17" - 22" Back: 18.5" W x 20" H COM: 1.5 yds. COL: 30 sq. ft. 43 lbs.	Black Nylon	991	1,051	1,093	1,117	1,159	1,203	1,243	1,285	1,324	1,368	1,563	1,705
		Polished Aluminum	1,070	1,130	1,172	1,196	1,238	1,282	1,322	1,364	1,403	1,447	1,642	1,784

Note:
For two-tone upholstery, COM requirements are .75 yd. for seat and 1 yd. for back.

OPTIONS

-FP01	Fully Polished Arms (no arm cap) (5694-U model only)	\$60	-STC02	Soft Tread Casters	\$26
-SS03	Seat Slider	\$76	-STLC02	Soft Tread Self-Locking Casters	\$52
-WA01	Width Adjustable Arms	\$30	-GD04	Glides	\$26
-PV01	Pivot Arms	\$55	-J01	Jury Base (black only)	\$150



All shipments for this series will be cartoned as standard. If blanket-wrapped shipping is required, please contact client services for additional information.

MEMENTO TASK

Task Intensive Mechanism

ORDERING REQUIREMENTS:

- Model number
- Arm finish, if applicable
- Base finish
- Upholstery selection
- Options, as applicable

MODEL	PRODUCT SPECIFICATIONS	BASE FINISH	FABRIC GRADES								LEATHER			
			COM	A	1	2	3	4	COL 5	6	7	8	L1	L2
5641-C 	Upholstered Channel Back, Armless 20" W x 22" D x 34.5"- 39.5" H Seat: 20.5" W x 18" D Seat Ht: 17" - 22" Back: 18.5" W x 20" H COM: 1.5 yds. COL: 30 sq. ft. 44 lbs.	Black Nylon	1,009	1,069	1,111	1,135	1,177	1,221	1,261	1,303	1,342	1,386	1,581	1,723
		Polished Aluminum	1,088	1,148	1,190	1,214	1,256	1,300	1,340	1,382	1,421	1,465	1,660	1,802
5643-C 	Upholstered Channel Back, Adjustable T-Arms 27" W x 22" D x 34.5"- 39.5" H Seat: 20.5" W x 18" D Seat Ht: 17" - 22" Back: 18.5" W x 20" H COM: 1.5 yds. COL: 30 sq. ft. 50 lbs.	Black Nylon	1,102	1,162	1,204	1,228	1,270	1,314	1,354	1,396	1,435	1,479	1,674	1,816
		Polished Aluminum	1,181	1,241	1,283	1,307	1,349	1,393	1,433	1,475	1,514	1,558	1,753	1,895
5644-C 	Upholstered Channel Back, Polished Aluminum Cantilever Arms 24.5" W x 22" D x 34.5"- 39.5" H Seat: 20.5" W x 18" D Seat Ht: 17" - 22" Back: 18.5" W x 20" H COM: 1.5 yds. COL: 30 sq. ft. 50 lbs.	Black Nylon	1,102	1,162	1,204	1,228	1,270	1,314	1,354	1,396	1,435	1,479	1,674	1,816
		Polished Aluminum	1,181	1,241	1,283	1,307	1,349	1,393	1,433	1,475	1,514	1,558	1,753	1,895

Note:
For two-tone upholstery, COM requirements are .75 yd. for seat and 1 yd. for back.

OPTIONS

-FP01	Fully Polished Arms (no arm cap) (5644-C model only)	\$60	-GD04	Glides	\$26
-SS03	Seat Slider	\$76	-J01	Jury Base (black only)	\$150
-WA01	Width Adjustable Arms	\$30			
-PV01	Pivot Arms	\$55			
-STC02	Soft Tread Casters	\$26			
-STLC02	Soft Tread Self-Locking Casters	\$52			



All shipments for this series will be cartoned as standard. If blanket-wrapped shipping is required, please contact client services for additional information.

MEMENTO TASK

Swivel-Tilt with Tilt Lock Mechanism

ORDERING REQUIREMENTS:

- Model number
- Arm finish, if applicable
- Base finish
- Upholstery selection
- Options, as applicable

MODEL	PRODUCT SPECIFICATIONS	BASE FINISH	FABRIC GRADES								LEATHER			
			COM	A	1	2	3	4	COL 5	6	7	8	L1	L2
5651-C 	Upholstered Channel Back, Armless 20" W x 22" D x 34.5"- 39.5" H Seat: 20.5" W x 18" D Seat Ht: 17" - 22" Back: 18.5" W x 20" H COM: 1.5 yds. COL: 30 sq. ft. 36 lbs.	Black Nylon	957	1,017	1,059	1,083	1,125	1,169	1,209	1,251	1,290	1,334	1,529	1,671
		Polished Aluminum	1,036	1,096	1,138	1,162	1,204	1,248	1,288	1,330	1,369	1,413	1,608	1,750
5653-C 	Upholstered Channel Back, Adjustable T-Arms 27" W x 22" D x 34.5"- 39.5" H Seat: 20.5" W x 18" D Seat Ht: 17" - 22" Back: 18.5" W x 20" H COM: 1.5 yds. COL: 30 sq. ft. 42 lbs.	Black Nylon	1,064	1,124	1,166	1,190	1,232	1,276	1,316	1,358	1,397	1,441	1,636	1,778
		Polished Aluminum	1,143	1,203	1,245	1,269	1,311	1,355	1,395	1,437	1,476	1,520	1,715	1,857
5654-C 	Upholstered Channel Back, Polished Aluminum Cantilever Arms 24.5" W x 22" D x 34.5"- 39.5" H Seat: 20.5" W x 18" D Seat Ht: 17" - 22" Back: 18.5" W x 20" H COM: 1.5 yds. COL: 30 sq. ft. 42 lbs.	Black Nylon	1,064	1,124	1,166	1,190	1,232	1,276	1,316	1,358	1,397	1,441	1,636	1,778
		Polished Aluminum	1,143	1,203	1,245	1,269	1,311	1,355	1,395	1,437	1,476	1,520	1,715	1,857

Note:
For two-tone upholstery, COM requirements are .75 yd. for seat and 1 yd. for back.

OPTIONS

-FP01	Fully Polished Arms (no arm cap) (5654-C model only)	\$60	-GD04	Glides	\$26
-SS02	Seat Slider	\$76	-SK01	Stool Kit ¹	\$90
-WA01	Width Adjustable Arms	\$30	-J01	Jury Base (black only)	\$150
-PV01	Pivot Arms	\$55	¹ Stool models feature non-tilting mechanism.		
-STC02	Soft Tread Casters	\$26			
-STLC02	Soft Tread Self-Locking Casters	\$52			



All shipments for this series will be cartoned as standard. If blanket-wrapped shipping is required, please contact client services for additional information.

MEMENTO TASK

Synchro-Tilt Mechanism

ORDERING REQUIREMENTS:

- Model number
- Arm finish, if applicable
- Base finish
- Upholstery selection
- Options, as applicable

MODEL	PRODUCT SPECIFICATIONS	BASE FINISH	FABRIC GRADES								LEATHER			
			COM	A	1	2	3	4	COL 5	6	7	8	L1	L2
5691-C 	Upholstered Channel Back, Armless 20" W x 22" D x 34.5"- 39.5" H Seat: 20.5" W x 18" D Seat Ht: 17" - 22" Back: 18.5" W x 20" H COM: 1.5 yds. COL: 30 sq. ft. 37 lbs.	Black Nylon	999	1,059	1,101	1,125	1,167	1,211	1,251	1,293	1,332	1,376	1,571	1,713
		Polished Aluminum	1,078	1,138	1,180	1,204	1,246	1,290	1,330	1,372	1,411	1,455	1,650	1,792
5693-C 	Upholstered Channel Back, Adjustable T-Arms 27" W x 22" D x 34.5"- 39.5" H Seat: 20.5" W x 18" D Seat Ht: 17" - 22" Back: 18.5" W x 20" H COM: 1.5 yds. COL: 30 sq. ft. 43 lbs.	Black Nylon	1,105	1,165	1,207	1,231	1,273	1,317	1,357	1,399	1,438	1,482	1,677	1,819
		Polished Aluminum	1,184	1,244	1,286	1,310	1,352	1,396	1,436	1,478	1,517	1,561	1,756	1,898
5694-C 	Upholstered Channel Back, Polished Aluminum Cantilever Arms 24.5" W x 22" D x 34.5"- 39.5" H Seat: 20.5" W x 18" D Seat Ht: 17" - 22" Back: 18.5" W x 20" H COM: 1.5 yds. COL: 30 sq. ft. 43 lbs.	Black Nylon	1,105	1,165	1,207	1,231	1,273	1,317	1,357	1,399	1,438	1,482	1,677	1,819
		Polished Aluminum	1,184	1,244	1,286	1,310	1,352	1,396	1,436	1,478	1,517	1,561	1,756	1,898

Note:
For two-tone upholstery, COM requirements are .75 yd. for seat and 1 yd. for back.

OPTIONS

-FP01	Fully Polished Arms (no arm cap) (5694-C model only)	\$60	-STC02	Soft Tread Casters	\$26
-SS02	Seat Slider	\$76	-STLC02	Soft Tread Self-Locking Casters	\$52
-WA01	Width Adjustable Arms	\$30	-GD04	Glides	\$26
-PV01	Pivot Arms	\$55	-J01	Jury Base (black only)	\$150

MOZIE GUEST/TANDEM



SPECIFICATIONS:

- Guest and tandem seating available individually or in tandem configurations with accompanying connecting tables.
- All dimensions are nominal.
- Please include seating layout drawings or sketch with each tandem order.
- Refer to terms and conditions for general information regarding fabrics, finishes, warranty, freight, complete condition of sales and more.

GUEST/TANDEM SEATING:

- Arm and armless models with open upholstered back.
- Arms feature black finish as standard.
- Silver arm finish also available. Please specify (-SA01) after model number and add \$22 list.
- Elliptical tubular steel frame.
- Three frame finish options. See below for options.
- Premium finishes also available. Please refer to standard finish card.
- Available with glides or on casters.
- Single guest chairs with glides or casters stack up to 4 high standing or 5 with dolly.
- Dolly not recommended for caster models.
- Guest chairs feature 400 lb. weight capacity.
- Bariatric models feature enhanced seat and back size and 750 lb. weight capacity.
- Optional ganging bracket available for chair to chair connection.
- Please note that to gang two chairs together, separate ganging brackets must be ordered for each unit.
- Ganging brackets fold under seat when not in use.
- Chairs are packaged two (2) to a carton.
- \$20 List carton break charge for less than two (2) chairs.

STANDARD METAL FRAME FINISH COLORS:

- #06 Charcoal Grey
- #90 Metallic Silver
- #95 Satin Black

PREMIUM METAL FRAME FINISH COLORS:

- #07 Gold Shimmer
- #08 Penny
- #09 Brown Sugar
- #83 Metallic Champagne
- #94 Cotton

MOZIE GUEST/TANDEM

CONNECTING TABLES:

- Straight models available in 9" and 18" widths.
- 90-degree model also offered.
- Laminate and solid surface top material options.
- Laminate tops are 3/4" thick, solid surface tops are 1/2" thick.
- Laminate available in all standard colors. Please refer to standard finish card.
- For custom laminate options, add \$550 List per color per order. Pre-approval required, please contact client services.
- Solid surface available in white only.
- Self edge standard. PVC edge also available.
- PVC edge available in three colors. See below for options.
- Tables are field installed.

PVC EDGE COLORS:

- White
- Slate Grey
- Black

All shipments for this series will be blanket-wrapped as standard. If cartoning is required, a 5% upcharge will be added to each product. Please contact client services for additional information.



MOZIE GUEST/TANDEM



#90 Metallic Silver frame finish only

ORDERING REQUIREMENTS:

- Model number
- Arm finish
- Frame finish
- Upholstery selection
- Options, as applicable

MODEL	PRODUCT SPECIFICATIONS	FABRIC GRADES										LEATHER	
		COM	A	1	2	3	4	COL 5	6	7	8	L1	L2
2715 	Guest Chair, Arms, Casters 24" W x 25" D x 32" H Seat: 19.5" W x 18" D Seat Ht: 18" Arm Ht: 25.5" COM: 1.5 yds. COL: 30 sq. ft. 28 lbs.	569	629	671	695	737	781	821	863	902	946	1,141	1,283
2735 	Guest Chair, Armless, Casters 21.5" W x 25" D x 32" H Seat: 19.5" W x 18" D Seat Ht: 18" COM: 1.5 yds. COL: 30 sq. ft. 26 lbs.	529	589	631	655	697	741	781	823	862	906	1,101	1,243

OPTIONS

-PF02	Premium Metal Frame Finish	\$80
-SA01	Silver Arms	\$22
-STC02	Soft Tread Casters	\$26
-GC05	Ganging Connector (per chair)	\$30
-FS01	1" Additional Seat Foam	\$30
-MB01	Moisture Barrier (seat only)	\$52

All shipments for this series will be blanket-wrapped as standard. If cartoning is required, a 5% upcharge will be added to each product. Please contact client services for additional information.



MOZIE GUEST/TANDEM



#90 Metallic Silver Frame
Finish Only

ORDERING REQUIREMENTS:

- Model number
- Arm finish
- Frame finish
- Upholstery selection
- Options, as applicable

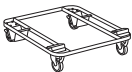
MODEL	PRODUCT SPECIFICATIONS	FABRIC GRADES								LEATHER			
		COM	A	1	2	3	4	COL 5	6	7	8	L1	L2
2710 	Guest Chair, Arms, Glides 24" W x 25" D x 32" H Seat: 19.5" W x 18" D Seat Ht: 18" Arm Ht: 25.5" COM: 1.5 yds. COL: 30 sq. ft. 28 lbs.	564	624	666	690	732	776	816	858	897	941	1,136	1,278
2730 	Guest Chair, Armless, Glides 21.5" W x 25" D x 32" H Seat: 19.5" W x 18" D Seat Ht: 18" COM: 1.5 yds. COL: 30 sq. ft. 26 lbs.	526	586	628	652	694	738	778	820	859	903	1,098	1,240
2500 	Dolly (Black Finish Only) 24" W x 30" D x 6" H Weight: 37 lbs.	337											

OPTIONS

-PF02	Premium Metal Frame Finish	\$80
-SA01	Silver Arms	\$22
-GC05	Ganging Connector (per chair)	\$30
-FS01	1" Additional Seat Foam	\$30
-MB01	Moisture Barrier (seat only)	\$52
-WS	Wall-Saver Leg	n/c

All shipments for this series will be blanket-wrapped as standard. If cartoning is required, a 5% upcharge will be added to each product. Please contact client services for additional information.

MOZIE GUEST/TANDEM



#90 Metallic Silver Frame
Finish Only

ORDERING REQUIREMENTS:

- Model number
- Arm finish
- Frame finish
- Upholstery selection
- Options, as applicable

MODEL	PRODUCT SPECIFICATIONS	FABRIC GRADES										LEATHER	
		COM	A	1	2	3	4	COL 5	6	7	8	L1	L2
2780	 <p>Bariatric Chair, Arms, Glides 34.5" W x 26" D x 33" H Seat: 30" W x 18" D Seat Ht: 19" Arm Ht: 26.5" COM: 2.25 yds. COL: 45 sq. ft. 55 lbs.</p>	943	1,033	1,096	1,132	1,195	1,261	1,321	1,384	1,443	1,508	1,801	2,014

OPTIONS

-PF02	Premium Metal Frame Finish	\$80
-SA01	Silver Arms	\$22
-FS03	1" Additional Seat Foam	\$75
-MB02	Moisture Barrier (seat only)	\$73
-WS	Wall-Saver Leg	n/c

All shipments for this series will be blanket-wrapped as standard. If cartoning is required, a 5% upcharge will be added to each product. Please contact client services for additional information.

MOZIE GUEST/TANDEM

ORDERING REQUIREMENTS:

- Model number
- Table top finish
- PVC edge color, as applicable

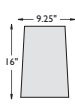
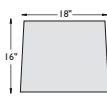
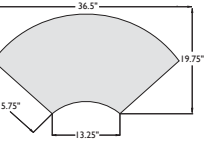
MODEL	PRODUCT SPECIFICATIONS	LAMINATE TOP (-L)	SOLID SURFACE TOP (-SF)	WEIGHT
2700-9-() 	9" Wide Connecting Table 9.25" W x 16" D	318	401	5
2700-18-() 	18" Wide Connecting Table 18" W x 16" D	381	505	10
2700-90-() 	90-Degree Connecting Table 36.5" W x 19.75" D	633	977	15

All shipments for this series will be blanket-wrapped as standard. If cartoning is required, a 5% upcharge will be added to each product. Please contact client services for additional information.

MOZIE GUEST/TANDEM - CONFIGURATION & ORDERING EXAMPLES



<u>Qty</u>	<u>Model #</u>	<u>Description</u>	<u>COM List</u>
2	2710	Tandem Unit (\$564 List each)	\$1,128
1	2700-18-L	18" Wide Connecting Table, Laminate Top	\$381
			\$1,509



<u>Qty</u>	<u>Model #</u>	<u>Description</u>	<u>COM List</u>
4	2710	Tandem Unit (\$564 List each)	\$2,256
3	2700-9-SF	9" Wide Connecting Table, Solid Surface Top (\$401 List each)	\$1,203
			\$3,459



<u>Qty</u>	<u>Model #</u>	<u>Description</u>	<u>COM List</u>
3	2710	Tandem Unit (\$564 List each)	\$1,692
2	2700-18-L	18" Wide Connecting Table, Laminate Top (\$381 List each)	\$762
1	2700-90-L	90-Degree Connecting Table, Laminate Top	\$633
1	2780	Bariatric Unit	\$943
			\$4,300

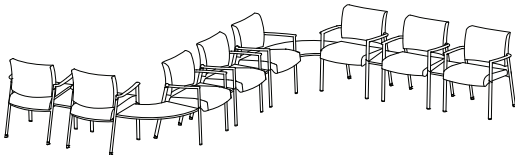

<u>Qty</u>	<u>Model #</u>	<u>Description</u>	<u>COM List</u>
8	2710	Tandem Unit, Open Back (\$564 List each)	\$4,512
5	2700-9-L	9" Wide Connecting Table, Laminate Top (\$318 List each)	\$1,590
2	2700-90-L	90-Degree Connecting Table, Laminate Top (\$633 List each)	\$1,266
			\$7,368

MOZIE OCCASIONAL TABLES



SPECIFICATIONS:

- Square and rectangular top shapes.
- Laminate and solid surface top material options.
- Laminate tops are $\frac{3}{4}$ " thick, solid surface tops are $\frac{1}{2}$ " thick.
- Laminate available in all standard colors. Please refer to standard finish card.
- For custom laminate options, add \$550 List per color per order. Pre-approval required, please contact client services.
- Solid surface available in white only.
- Self edge standard. PVC edge also available in three colors. See below for options.
- Round metal legs available in standard and premium finishes. Refer to options below.
- Apron finish will match leg finish unless specified otherwise.
- All dimensions are nominal.
- Refer to terms and conditions for general information regarding fabrics, finishes, warranty, freight, complete condition of sales and more.

STANDARD METAL LEG FINISH COLORS:

- #06 Charcoal Grey
- #90 Metallic Silver
- #95 Satin Black

PREMIUM METAL LEG FINISH COLORS:

- #07 Gold Shimmer
- #08 Penny
- #09 Brown Sugar
- #83 Metallic Champagne
- #94 Cotton

PVC EDGE COLORS:

- White
- Slate Grey
- Black

All shipments for this series will be blanket-wrapped as standard. If cartoning is required, a 5% upcharge will be added to each product. Please contact client services for additional information.

MOZIE OCCASIONAL TABLES

ORDERING REQUIREMENTS:

- Model number
- Table top finish
- PVC edge color, as applicable
- Leg finish
- Options, as applicable

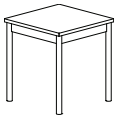
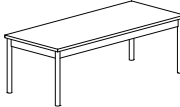
	MODEL	DIMENSIONS	LAMINATE TOP (-L)	SOLID SURFACE TOP (-SF)	WEIGHT
	Square Table				
	270-181820-()	18" W x 18" D x 20" H	699	823	16
	270-222220-()	22" W x 22" D x 20" H	769	989	20
	270-303020-()	30" W x 30" D x 20" H	968	1,312	25
	270-363620-()	36" W x 36" D x 20" H	1,313	1,988	30
	Rectangular Table				
	270-482016-()	48" W x 20" D x 16" H	1,052	1,652	36

OPTIONS

-PF02 Premium Metal Leg Finish \$80

NEXXT GUEST | Designed by Francisco Romero of PhiDesign



SPECIFICATIONS:

- Fully upholstered and polypropylene back models available.
- Polypropylene back available in eight colors.
- Two arm options: armless or signature black arms.
- Elliptical tubular steel frame.
- Two frame finish options: #90 Metallic Silver or #95 Satin Black.
- For custom finish colors, please contact client services for pricing.
- Wall-saver leg design.
- Available with glides or on casters.
- Chairs with glides or casters stack up to 4 high standing or 5 with dolly.
- Optional ganging device available.
- Chairs are packaged three (3) to a carton.
- \$20 List carton break charge for less than three (3) chairs.
- Orders for thirty (30) or more chairs will not be subject to carton break upcharge.
- 300 lb. weight capacity.
- All dimensions are nominal.
- Refer to terms and conditions for general information regarding fabrics, finishes, warranty, freight, complete condition of sales and more.

STANDARD METAL FRAME FINISH COLORS:

- #90 Metallic Silver
- #95 Satin Black

POLYPROPYLENE COLORS:

- #30 Very Black
- #31 Medium Grey
- #32 Soft White
- #40 Cocoa
- #42 Mimosa
- #44 Sky
- #46 Scarlet
- #48 Key Lime





NEXXT GUEST | Designed by Francisco Romero of PhiDesign



#90 Metallic Silver
frame finish only

ORDERING REQUIREMENTS:

- Model number
- Frame finish
- Upholstery selection
- Options, as applicable

MODEL	PRODUCT SPECIFICATIONS	FABRIC GRADES										LEATHER	
		COM	A	1	2	3	4	COL 5	6	7	8	L1	L2
3210 	Guest/Stack Chair, Fully Upholstered, Arms, Glides 24" W x 23" D x 33" H Seat: 17.25" W x 18.25" D Seat Ht: 18" Arm Ht: 27.75" COM: 1.25 yds. COL: 25 sq. ft. 28 lbs.	520	570	605	625	660	697	730	765	798	834	997	1,115
3215 	Guest/Stack Chair, Fully Upholstered, Arms, Casters 24" W x 23" D x 33" H Seat: 17.25" W x 18.25" D Seat Ht: 18" Arm Ht: 27.75" COM: 1.25 yds. COL: 25 sq. ft. 28 lbs.	523	573	608	628	663	700	733	768	801	837	1,000	1,118
3230 	Guest/Stack Chair, Fully Upholstered, Armless, Glides 22.5" W x 23" D x 33" H Seat: 17.25" W x 18.25" D Seat Ht: 18" COM: 1.25 yds. COL: 25 sq. ft. 26 lbs.	488	538	573	593	628	665	698	733	766	802	965	1,083
3235 	Guest/Stack Chair, Fully Upholstered, Armless, Casters 22.5" W x 23" D x 33" H Seat: 17.25" W x 18.25" D Seat Ht: 18" COM: 1.25 yds. COL: 25 sq. ft. 26 lbs.	487	537	572	592	627	664	697	732	765	801	964	1,082

OPTIONS



-FS01	1" Additional Seat Foam	\$30
-STC02	Soft Tread Casters	\$26
-GC06	Ganging Connector	\$30

All shipments for this series will be blanket-wrapped as standard. If cartoning is required, a 5% upcharge will be added to each product. Please contact client services for additional information.

NEXXT GUEST | Designed by Francisco Romero of PhiDesign

ORDERING REQUIREMENTS:

- Model number
- Back color
- Frame finish
- Upholstery selection
- Options, as applicable

MODEL	PRODUCT SPECIFICATIONS	FABRIC GRADES										LEATHER	
		COM	A	1	2	3	4	COL 5	6	7	8	L1	L2
3210-P 	Guest Chair, Poly-Back, Arms, Glides 24" W x 23" D x 34" H Seat: 17.25" W x 18.25" D Seat Ht: 18" Arm Ht: 27.75" COM: .75 yd. COL: 15 sq. ft. 26 lbs.	475	505	526	538	559	581	601	622	642	664	761	832
3215-P 	Guest Chair, Poly-Back, Arms, Casters 24" W x 23" D x 34" H Seat: 17.25" W x 18.25" D Seat Ht: 18" Arm Ht: 27.75" COM: .75 yd. COL: 15 sq. ft. 26 lbs.	481	511	532	544	565	587	607	628	648	670	767	838

OPTIONS



- FS01 1" Additional Seat Foam \$30
- STC02 Soft Tread Casters \$26
- GC06 Ganging Connector \$30

All shipments for this series will be blanket-wrapped as standard. If cartoning is required, a 5% upcharge will be added to each product. Please contact client services for additional information.

NEXXT GUEST | Designed by Francisco Romero of PhiDesign

ORDERING REQUIREMENTS:

- Model number
- Back color
- Frame finish
- Upholstery selection
- Options, as applicable

MODEL	PRODUCT SPECIFICATIONS	FABRIC GRADES										LEATHER	
		COM	A	1	2	3	4	COL 5	6	7	8	L1	L2
3230-P 	Guest Chair, Poly-Back , Armless, Glides 22.5" W x 23" D x 34" H Seat: 17.25" W x 18.25" D Seat Ht: 18" COM: .75 yd. COL: 15 sq. ft. 24 lbs.	442	472	493	505	526	548	568	589	609	631	728	799
3235-P 	Guest Chair, Poly-Back, Armless, Casters 22.5" W x 23" D x 34" H Seat: 17.25" W x 18.25" D Seat Ht: 18" COM: .75 yd. COL: 15 sq. ft. 24 lbs.	443	473	494	506	527	549	569	590	610	632	729	800
2500 	Dolly (Black Finish Only) 24" W x 30" D x 6" H Weight: 37 lbs.	337											

OPTIONS

-FS01	1" Additional Seat Foam	\$30
-STC02	Soft Tread Casters	\$26
-GC06	Ganging Connector	\$30

NEXXT NESTING | Designed by Francisco Romero of PhiDesign



SPECIFICATIONS:

- Fully upholstered and polypropylene back models available.
- Polypropylene back available in eight colors.
- Two arm options: armless or signature black arms.
- Elliptical tubular steel frame.
- Two frame finish options: #90 Metallic Silver or #95 Satin Black.
- For custom finish colors, please contact client services for pricing.
- Wall-saver leg design.
- Arm and armless chairs stack up to 4 high standing.
- Arm and armless chair seat flips up to allow nesting capabilities.
- Chairs are packaged three (3) to a carton.
- \$20 List carton break charge for less than three (3) chairs.
- Orders for thirty (30) or more chairs will not be subject to carton break upcharge.
- 300 lb. weight capacity.
- All dimensions are nominal.
- Refer to terms and conditions for general information regarding fabrics, finishes, warranty, freight, complete condition of sales and more.

STANDARD METAL FRAME FINISH COLORS:

- #90 Metallic Silver
- #95 Satin Black

POLYPROPYLENE COLORS:

- #30 Very Black
- #31 Medium Grey
- #32 Soft White
- #40 Cocoa
- #42 Mimosa
- #44 Sky
- #46 Scarlet
- #48 Key Lime

All shipments for this series will be blanket-wrapped as standard. If cartoning is required, a 5% upcharge will be added to each product. Please contact client services for additional information.



NEXXT NESTING | Designed by Francisco Romero of PhiDesign



#90 Metallic Silver
Frame Finish Only

ORDERING REQUIREMENTS:

- Model number
- Frame finish
- Upholstery selection
- Options, as applicable

MODEL	PRODUCT SPECIFICATIONS	FABRIC GRADES										LEATHER	
		COM	A	1	2	3	4	COL 5	6	7	8	L1	L2
3115 	Nesting/Stack Chair, Fully Upholstered, Arms, Casters 24" W x 23" D x 33" H Seat: 17.25" W x 18.25" D Seat Ht: 18" Arm Ht: 27.75" COM: 1.25 yds. COL: 25 sq. ft. 28 lbs.	607	657	692	712	747	784	817	852	885	921	1,084	1,202
3135 	Nesting/Stack Chair, Fully Upholstered, Armless, Casters 22.5" W x 23" D x 33" H Seat: 17.25" W x 18.25" D Seat Ht: 18" COM: 1.25 yds. COL: 25 sq. ft. 26 lbs.	556	606	641	661	696	733	766	801	834	870	1,033	1,151

OPTIONS



- FS01 1" Additional Seat Foam \$30
- STC02 Soft Tread Casters \$26

All shipments for this series will be blanket-wrapped as standard. If cartoning is required, a 5% upcharge will be added to each product. Please contact client services for additional information.

NEXXT NESTING | Designed by Francisco Romero of PhiDesign

ORDERING REQUIREMENTS:

- Model number
- Back color
- Frame finish
- Upholstery selection
- Options, as applicable

MODEL	PRODUCT SPECIFICATIONS	FABRIC GRADES										LEATHER	
		COM	A	1	2	3	4	COL 5	6	7	8	L1	L2
3115-P 	Nesting/Stack Chair, Poly-Back, Arms, Casters 24" W x 23" D x 33" H Seat: 17.25" W x 18.25" D Seat Ht: 18" Arm Ht: 27.75" COM: .75 yd. COL: 15 sq. ft. 26 lbs.	558	588	609	621	642	664	684	705	725	747	844	915
3135-P 	Nesting/Stack Chair, Poly-Back, Armless, Casters 22.5" W x 23" D x 33" H Seat: 17.25" W x 18.25" D Seat Ht: 18" COM: .75 yd. COL: 15 sq. ft. 26 lbs.	505	535	556	568	589	611	631	652	672	694	791	862

OPTIONS

- FS01 1" Additional Seat Foam \$30
- STC02 Soft Tread Casters \$26

NEXXT NESTING/GUEST | Designed by Francisco Romero of PhiDesign

UPHOLSTERY COMBINATIONS:

- For upholstery combinations, refer to the pricing below.
- When combining two COM/COV/COL fabrics, or fabrics with the same grade, add \$85 List per unit.
- When combining three or more COM/COV/COL fabrics, or fabrics with the same grade, add \$115 List per unit.
- When combining different grades of fabric, price will be based on the highest grade specified.
- Two-tone upholstery examples and yardage requirements for the most common combinations are listed below. Additional combinations available; please contact client Services for yardage requirements and pricing.
- Note: Yardage amounts are based on fabric which is plain (i.e. non-directional) and a full 54" wide.
- Appropriate upholstery code must be included.



Code	NX1
<u>Model</u>	<u>COM Requirement</u>
3115	Back = .75 yd.
3135	Seat = .75 yd.



Code	NX2
<u>Model</u>	<u>COM Requirement</u>
3210	Back = .75 yd.
3215	Seat = .75 yd.
3230	
3235	

All shipments for this series will be cartoned as standard. If blanket-wrapped shipping is required, please contact client services for additional information.

NEXXT TASK | Designed by Francisco Romero of PhiDesign



SPECIFICATIONS:

- Fully upholstered and polypropylene back models available.
- Polypropylene back available in eight colors. Please refer to listing below.
- 8" stool travel.
- Armless, adjustable t-arm and fixed cantilever arm models.
- Adjustable t-arms available in black or chrome trim detail.
- Black adjustable t-arm finish is standard unless specified otherwise.
- Adjustable t-arm features 4" arm height adjustment as standard.
- Elliptical tubular steel frame.
- Two frame finish options: #90 Metallic Silver or #95 Satin Black.
- Fixed back height.
- Two base options: black nylon and polished aluminum.
- Polished aluminum base option reduces seat height by 1½".
- 300 lb. weight capacity.
- Ships KD (knocked down).
- All dimensions are nominal.
- Swivel and swivel-tilt with tilt lock mechanism models available. Refer to pages 13-15 for mechanism guide.
- Refer to terms and conditions for general information regarding fabrics, finishes, warranty, freight, complete condition of sales and more.

STANDARD METAL FRAME FINISH COLORS:

- #90 Metallic Silver
- #95 Satin Black

POLYPROPYLENE COLORS:

- #30 Very Black
- #31 Medium Grey
- #32 Soft White
- #40 Cocoa
- #42 Mimosa
- #44 Sky
- #46 Scarlet
- #48 Key Lime



All shipments for this series will be cartoned as standard. If blanket-wrapped shipping is required, please contact client services for additional information.

NEXXT TASK | Designed by Francisco Romero of PhiDesign

Non-Tilt, Height Adjustable Swivel Mechanism

ORDERING REQUIREMENTS:

- Model number
- Base finish
- Frame finish
- Upholstery selection
- Options, as applicable

MODEL	PRODUCT SPECIFICATIONS	BASE FINISH	FABRIC GRADES								LEATHER			
			COM	A	1	2	3	4	COL 5	6	7	8	L1	L2
3311 	Fully Upholstered, Armless 18.5" W x 23.5" D x 33.5" - 38.5" H Seat: 18.5" W x 18.25" D Seat Ht: 17" - 22" Back: 17.75" W x 15" H COM: 1.25 yds. COL: 25 sq. ft. 35 lbs.	Black Nylon	719	769	804	824	859	896	929	964	997	1,033	1,196	1,314
		Polished Aluminum	798	848	883	903	938	975	1,008	1,043	1,076	1,112	1,275	1,393
3313 	Fully Upholstered, Adjustable T-Arms 24" W x 23.5" D x 33.5" - 38.5" H Seat: 18.5" W x 18.25" D Seat Ht: 17" - 22" Back: 17.75" W x 15" H COM: 1.25 yds. COL: 25 sq. ft. 39 lbs.	Black Nylon	838	888	923	943	978	1,015	1,048	1,083	1,116	1,152	1,315	1,433
		Polished Aluminum	917	967	1,002	1,022	1,057	1,094	1,127	1,162	1,195	1,231	1,394	1,512
3314 	Fully Upholstered, Fixed Cantilever Arms 24" W x 23.5" D x 33.5" - 38.5" H Seat: 18.5" W x 18.25" D Seat Ht: 17" - 22" Back: 17.75" W x 15" H COM: 1.25 yds. COL: 25 sq. ft. 37 lbs.	Black Nylon	774	824	859	879	914	951	984	1,019	1,052	1,088	1,251	1,369
		Polished Aluminum	853	903	938	958	993	1,030	1,063	1,098	1,131	1,167	1,330	1,448

OPTIONS

-WA01	Width Adjustable Arms	\$30
-PV01	Pivot Arms	\$55
-FS01	1" Additional Seat Foam	\$30
-STC02	Soft Tread Casters	\$26
-STLC02	Soft Tread Self-Locking Casters	\$52
-GD04	Glides	\$26
-J01	Jury Base (black only)	\$150



All shipments for this series will be cartoned as standard. If blanket-wrapped shipping is required, please contact client services for additional information.

NEXXT TASK | Designed by Francisco Romero of PhiDesign

Swivel-Tilt with Tilt Lock Mechanism

ORDERING REQUIREMENTS:

- Model number
- Frame finish
- Base finish
- Upholstery selection
- Options, as applicable

MODEL	PRODUCT SPECIFICATIONS	BASE FINISH	FABRIC GRADES								LEATHER			
			COM	A	1	2	3	4	COL 5	6	7	8	L1	L2
3351 	Fully Upholstered, Armless 18.5" W x 23.5" D x 33.5" - 38.5" H Seat: 18.5" W x 18.25" D Seat Ht: 17" - 22" Back: 17.75" W x 15" H COM: 1.25 yds. COL: 25 sq. ft. 35 lbs.	Black Nylon	765	815	850	870	905	942	975	1,010	1,043	1,079	1,242	1,360
		Polished Aluminum	844	894	929	949	984	1,021	1,054	1,089	1,122	1,158	1,321	1,439
3353 	Fully Upholstered, Adjustable T-Arms 24" W x 23.5" D x 33.5" - 38.5" H Seat: 18.5" W x 18.25" D Seat Ht: 17" - 22" Back: 17.75" W x 15" H COM: 1.25 yds. COL: 25 sq. ft. 39 lbs.	Black Nylon	866	916	951	971	1,006	1,043	1,076	1,111	1,144	1,180	1,343	1,461
		Polished Aluminum	945	995	1,030	1,050	1,085	1,122	1,155	1,190	1,223	1,259	1,422	1,540
3354 	Fully Upholstered, Fixed Cantilever Arms 24" W x 23.5" D x 33.5" - 38.5" H Seat: 18.5" W x 18.25" D Seat Ht: 17" - 22" Back: 17.75" W x 15" H COM: 1.25 yds. COL: 25 sq. ft. 37 lbs.	Black Nylon	802	852	887	907	942	979	1,012	1,047	1,080	1,116	1,279	1,397
		Polished Aluminum	881	931	966	986	1,021	1,058	1,091	1,126	1,159	1,195	1,358	1,476

OPTIONS

-WA01	Width Adjustable Arms	\$30
-PV01	Pivot Arms	\$55
-FS01	1" Additional Seat Foam	\$30
-STC02	Soft Tread Casters	\$26
-STLC02	Soft Tread Self-Locking Casters	\$52
-GD04	Glides	\$26
-J01	Jury Base (black only)	\$150



All shipments for this series will be cartoned as standard. If blanket-wrapped shipping is required, please contact client services for additional information.

NEXXT TASK | Designed by Francisco Romero of PhiDesign

Non-Tilt, Height Adjustable Swivel Mechanism

ORDERING REQUIREMENTS:

- Model number
- Frame finish
- Base finish
- Upholstery selection
- Options, as applicable

MODEL	PRODUCT SPECIFICATIONS	BASE FINISH	FABRIC GRADES								LEATHER			
			COM	A	1	2	3	4	COL 5	6	7	8	L1	L2
3361 	Fully Upholstered, Stool, Armless 20" W x 20" D x 40" - 48" H Seat: 18.5" W x 18.25" D Seat Ht: 23" - 31" Back: 17.75" W x 15" H COM: 1.25 yds. COL: 25 sq. ft. 36 lbs.	Black Nylon	952	1,002	1,037	1,057	1,092	1,129	1,162	1,197	1,230	1,266	1,429	1,547
		Polished Aluminum	1,031	1,081	1,116	1,136	1,171	1,208	1,241	1,276	1,309	1,345	1,508	1,626
3363 	Fully Upholstered, Stool, Adjustable T-Arms 24" W x 20" D x 40" - 48" H Seat: 18.5" W x 18.25" D Seat Ht: 23" - 31" Back: 17.75" W x 15" H COM: 1.25 yds. COL: 25 sq. ft. 42 lbs.	Black Nylon	1,043	1,093	1,128	1,148	1,183	1,220	1,253	1,288	1,321	1,357	1,520	1,638
		Polished Aluminum	1,122	1,172	1,207	1,227	1,262	1,299	1,332	1,367	1,400	1,436	1,599	1,717
3364 	Fully Upholstered, Stool, Fixed Cantilever Arms 24" W x 20" D x 40" - 48" H Seat: 18.5" W x 18.25" D Seat Ht: 23" - 31" Back: 17.75" W x 15" H COM: 1.25 yds. COL: 25 sq. ft. 40 lbs.	Black Nylon	987	1,037	1,072	1,092	1,127	1,164	1,197	1,232	1,265	1,301	1,464	1,582
		Polished Aluminum	1,066	1,116	1,151	1,171	1,206	1,243	1,276	1,311	1,344	1,380	1,543	1,661

OPTIONS

-WA01	Width Adjustable Arms	\$30
-PV01	Pivot Arms	\$55
-FS01	1" Additional Seat Foam	\$30
-STC02	Soft Tread Casters	\$26
-STLC02	Soft Tread Self-Locking Casters	\$52
-GD04	Glides	\$26



All shipments for this series will be cartoned as standard. If blanket-wrapped shipping is required, please contact client services for additional information.

NEXXT TASK | Designed by Francisco Romero of PhiDesign

Non-Tilt, Height Adjustable Swivel Mechanism

ORDERING REQUIREMENTS:

- Model number
- Arm finish, as applicable
- Frame finish
- Base finish
- Poly-back color
- Upholstery selection
- Options, as applicable

MODEL	PRODUCT SPECIFICATIONS	BASE FINISH	FABRIC GRADES								LEATHER			
			COM	A	1	2	3	4	COL 5	6	7	8	L1	L2
3311-P 	Poly-Back, Armless 18.5" W x 23.5" D x 33.5" - 38.5" H Seat: 18.5" W x 18.25" D Seat Ht: 17" - 22" Back: 17.75" W x 15" H COM: .75 yd. COL: 15 sq. ft. 33 lbs.	Black Nylon	705	735	756	768	789	811	831	852	872	894	991	1,062
		Polished Aluminum	784	814	835	847	868	890	910	931	951	973	1,070	1,141
3313-P 	Poly-Back, Adjustable T-Arms 24" W x 23.5" D x 33.5" - 38.5" H Seat: 18.5" W x 18.25" D Seat Ht: 17" - 22" Back: 17.75" W x 15" H COM: .75 yd. COL: 15 sq. ft. 37 lbs.	Black Nylon	804	834	855	867	888	910	930	951	971	993	1,090	1,161
		Polished Aluminum	883	913	934	946	967	989	1,009	1,030	1,050	1,072	1,169	1,240
3314-P 	Poly-Back, Fixed Cantilever Arms 24" W x 23.5" D x 33.5" - 38.5" H Seat: 18.5" W x 18.25" D Seat Ht: 17" - 22" Back: 17.75" W x 15" H COM: .75 yd. COL: 15 sq. ft. 35 lbs.	Black Nylon	741	771	792	804	825	847	867	888	908	930	1,027	1,098
		Polished Aluminum	820	850	871	883	904	926	946	967	987	1,009	1,106	1,177

OPTIONS

-WA01	Width Adjustable Arms	\$30
-PV01	Pivot Arms	\$55
-FS01	1" Additional Seat Foam	\$30
-STC02	Soft Tread Casters	\$26
-STLC02	Soft Tread Self-Locking Casters	\$52
-GD04	Glides	\$26
-J01	Jury Base (black only)	\$150



All shipments for this series will be cartoned as standard. If blanket-wrapped shipping is required, please contact client services for additional information.

NEXXT TASK | Designed by Francisco Romero of PhiDesign

Swivel-Tilt with Tilt Lock Mechanism

ORDERING REQUIREMENTS:

- Model number
- Arm finish, as applicable
- Frame finish
- Base finish
- Poly-back color
- Upholstery selection
- Options, as applicable

MODEL	PRODUCT SPECIFICATIONS	BASE FINISH	FABRIC GRADES								LEATHER			
			COM	A	1	2	3	4	COL 5	6	7	8	L1	L2
3351-P 	Poly-Back, Armless 18.5" W x 23.5" D x 33.5" - 38.5" H Seat: 18.5" W x 18.25" D Seat Ht: 17" - 22" Back: 17.75" W x 15" H COM: .75 yd. COL: 15 sq. ft. 33 lbs.	Black Nylon	727	757	778	790	811	833	853	874	894	916	1,013	1,084
		Polished Aluminum	806	836	857	869	890	912	932	953	973	995	1,092	1,163
3353-P 	Poly-Back, Adjustable T-Arms 24" W x 23.5" D x 33.5" - 38.5" H Seat: 18.5" W x 18.25" D Seat Ht: 17" - 22" Back: 17.75" W x 15" H COM: .75 yd. COL: 15 sq. ft. 37 lbs.	Black Nylon	822	852	873	885	906	928	948	969	989	1,011	1,108	1,179
		Polished Aluminum	901	931	952	964	985	1,007	1,027	1,048	1,068	1,090	1,187	1,258
3354-P 	Poly-Back, Fixed Cantilever Arms 24" W x 23.5" D x 33.5" - 38.5" H Seat: 18.5" W x 18.25" D Seat Ht: 17" - 22" Back: 17.75" W x 15" H COM: .75 yd. COL: 15 sq. ft. 35 lbs.	Black Nylon	759	789	810	822	843	865	885	906	926	948	1,045	1,116
		Polished Aluminum	838	868	889	901	922	944	964	985	1,005	1,027	1,124	1,195

OPTIONS

-WA01	Width Adjustable Arms	\$30
-PV01	Pivot Arms	\$55
-FS01	1" Additional Seat Foam	\$30
-STC02	Soft Tread Casters	\$26
-STLC02	Soft Tread Self-Locking Casters	\$52
-GD04	Glides	\$26
-J01	Jury Base (black only)	\$150



All shipments for this series will be cartoned as standard. If blanket-wrapped shipping is required, please contact client services for additional information.

NEXXT TASK | Designed by Francisco Romero of PhiDesign

Non-Tilt, Height Adjustable Swivel Mechanism

ORDERING REQUIREMENTS:

- Model number
- Arm finish, as applicable
- Frame finish
- Base finish
- Poly-back color
- Upholstery selection
- Options, as applicable

MODEL	PRODUCT SPECIFICATIONS	BASE FINISH	FABRIC GRADES								LEATHER			
			COM	A	1	2	3	4	COL 5	6	7	8	L1	L2
3361-P 	Poly-Back, Stool, Armless 20" W x 20" D x 40" - 48" H Seat: 18.5" W x 18.25" D Seat Ht: 23" - 31" Back: 17.75" W x 15" H COM: .75 yd. COL: 15 sq. ft. 34 lbs.	Black Nylon	917	947	968	980	1,001	1,023	1,043	1,064	1,084	1,106	1,203	1,274
		Polished Aluminum	996	1,026	1,047	1,059	1,080	1,102	1,122	1,143	1,163	1,185	1,282	1,353
3363-P 	Poly-Back, Stool, Adjustable T-Arms 24" W x 20" D x 40" - 48" H Seat: 18.5" W x 18.25" D Seat Ht: 23" - 31" Back: 17.75" W x 15" H COM: .75 yd. COL: 15 sq. ft. 40 lbs.	Black Nylon	1,005	1,035	1,056	1,068	1,089	1,111	1,131	1,152	1,172	1,194	1,291	1,362
		Polished Aluminum	1,084	1,114	1,135	1,147	1,168	1,190	1,210	1,231	1,251	1,273	1,370	1,441
3364-P 	Poly-Back, Stool, Fixed Cantilever Arms 24" W x 20" D x 40" - 48" H Seat: 18.5" W x 18.25" D Seat Ht: 23" - 31" Back: 17.75" W x 15" H COM: .75 yd. COL: 15 sq. ft. 40 lbs.	Black Nylon	942	972	993	1,005	1,026	1,048	1,068	1,089	1,109	1,131	1,228	1,299
		Polished Aluminum	1,021	1,051	1,072	1,084	1,105	1,127	1,147	1,168	1,188	1,210	1,307	1,378

OPTIONS

-WA01	Width Adjustable Arms	\$30
-PV01	Pivot Arms	\$55
-FS01	1" Additional Seat Foam	\$30
-STC02	Soft Tread Casters	\$26
-STLC02	Soft Tread Self-Locking Casters	\$52
-GD04	Glides	\$26

NOTION



SPECIFICATIONS:

- Armless, adjustable t-arm and signature fixed aluminum arm models.
- Adjustable t-arm features 3" arm height travel as standard.
- Fixed aluminum arm available with beech wood or black urethane arm caps.
- Beech wood arm caps available in seven finishes. Please refer to standard finish card.
- Fixed aluminum arm features #92 Polished Aluminum finish as standard.
- #06 Charcoal Grey and #90 Metallic Silver finishes also available at no upcharge, please specify.
- 8" stool travel.
- 2½" back height adjustment and fixed back height models available.
- Two base options: black nylon and polished aluminum.
- 300 lb. weight capacity.
- All dimensions are nominal.
- Synchro-tilt, synchro knee-tilt, swivel-tilt with tilt lock, multi-lever and task intensive mechanism. Refer to pages 13-15 for mechanism guide.
- Refer to terms and conditions for general information regarding fabrics, finishes, warranty, freight, complete condition of sales and more.





All shipments for this series will be cartoned as standard. If blanket-wrapped shipping is required, please contact client services for additional information.

NOTION

Task Intensive Mechanism

ORDERING REQUIREMENTS:

- Model number
- Arm cap finish, as applicable
- Base finish
- Upholstery selection
- Options, as applicable

MODEL	PRODUCT SPECIFICATIONS	BASE FINISH	FABRIC GRADES								LEATHER			
			COM	A	1	2	3	4	COL 5	6	7	8	L1	L2
4241-L 	Low Back, Armless 20" W x 23.5" D x 33.5" - 37.5" H Seat: 20" W x 18.5" D Seat Ht: 17" - 21" Back: 19.5" W x 19" - 21.5" H COM: 1.5 yds. COL: 30 sq. ft. 48 lbs.	Black Nylon	927	987	1,029	1,053	1,095	1,139	1,179	1,221	1,260	1,304	1,499	1,641
		Polished Aluminum	1,006	1,066	1,108	1,132	1,174	1,218	1,258	1,300	1,339	1,383	1,578	1,720
4243-L 	Low Back, Adjustable T-Arms 26" W x 23.5" D x 33.5" - 37.5" H Seat: 20" W x 18.5" D Seat Ht: 17" - 21" Back: 19.5" W x 19" - 21.5" H COM: 1.5 yds. COL: 30 sq. ft. 50 lbs.	Black Nylon	997	1,057	1,099	1,123	1,165	1,209	1,249	1,291	1,330	1,374	1,569	1,711
		Polished Aluminum	1,076	1,136	1,178	1,202	1,244	1,288	1,328	1,370	1,409	1,453	1,648	1,790
4244-L-U 	Low Back, Fixed Aluminum Arms, Black Urethane Arm Caps 24.5" W x 23.5" D x 33.5" - 37.5" H Seat: 20" W x 18.5" D Seat Ht: 17" - 21" Back: 19.5" W x 19" - 21.5" H COM: 1.5 yds. COL: 30 sq. ft. 50 lbs.	Black Nylon	1,116	1,176	1,218	1,242	1,284	1,328	1,368	1,410	1,449	1,493	1,688	1,830
		Polished Aluminum	1,195	1,255	1,297	1,321	1,363	1,407	1,447	1,489	1,528	1,572	1,767	1,909
4244-L-W 	Low Back, Fixed Aluminum Arms, Beech Wood Arm Caps 24.5" W x 23.5" D x 33.5" - 37.5" H Seat: 20" W x 18.5" D Seat Ht: 17" - 21" Back: 19.5" W x 19" - 21.5" H COM: 1.5 yds. COL: 30 sq. ft. 50 lbs.	Black Nylon	1,116	1,176	1,218	1,242	1,284	1,328	1,368	1,410	1,449	1,493	1,688	1,830
		Polished Aluminum	1,202	1,262	1,304	1,328	1,370	1,414	1,454	1,496	1,535	1,579	1,774	1,916

OPTIONS

- GD04 Glides \$26
- STC02 Soft Tread Casters \$26
- J01 Jury Base (black only) \$150





All shipments for this series will be cartoned as standard. If blanket-wrapped shipping is required, please contact client services for additional information.

NOTION

Swivel-Tilt with Tilt Lock Mechanism

ORDERING REQUIREMENTS:

- Model number
- Arm cap finish, as applicable
- Base finish
- Upholstery selection
- Options, as applicable

MODEL	PRODUCT SPECIFICATIONS	BASE FINISH	FABRIC GRADES								LEATHER			
			COM	A	1	2	3	4	COL 5	6	7	8	L1	L2
4251-L 	Low Back, Armless 20" W x 23.5" D x 33.5" - 37.5" H Seat: 20" W x 18.5" D Seat Ht: 17" - 21" Back: 19.5" W x 19" - 21.5" H COM: 1.5 yds. COL: 30 sq. ft. 40 lbs.	Black Nylon	871	931	973	997	1,039	1,083	1,123	1,165	1,204	1,248	1,443	1,585
		Polished Aluminum	950	1,010	1,052	1,076	1,118	1,162	1,202	1,244	1,283	1,327	1,522	1,664
4253-L 	Low Back, Adjustable T-Arms 26" W x 23.5" D x 33.5" - 37.5" H Seat: 20" W x 18.5" D Seat Ht: 17" - 21" Back: 19.5" W x 19" - 21.5" H COM: 1.5 yds. COL: 30 sq. ft. 42 lbs.	Black Nylon	939	999	1,041	1,065	1,107	1,151	1,191	1,233	1,272	1,316	1,511	1,653
		Polished Aluminum	1,018	1,078	1,120	1,144	1,186	1,230	1,270	1,312	1,351	1,395	1,590	1,732
4254-L-U 	Low Back, Fixed Aluminum Arms, Black Urethane Arm Caps 24.5" W x 23.5" D x 33.5" - 37.5" H Seat: 20" W x 18.5" D Seat Ht: 17" - 21" Back: 19.5" W x 19" - 21.5" H COM: 1.5 yds. COL: 30 sq. ft. 42 lbs.	Black Nylon	1,059	1,119	1,161	1,185	1,227	1,271	1,311	1,353	1,392	1,436	1,631	1,773
		Polished Aluminum	1,138	1,198	1,240	1,264	1,306	1,350	1,390	1,432	1,471	1,515	1,710	1,852
4254-L-W 	Low Back, Fixed Aluminum Arms, Beech Wood Arm Caps 24.5" W x 23.5" D x 33.5" - 37.5" H Seat: 20" W x 18.5" D Seat Ht: 17" - 21" Back: 19.5" W x 19" - 21.5" H COM: 1.5 yds. COL: 30 sq. ft. 42 lbs.	Black Nylon	1,059	1,119	1,161	1,185	1,227	1,271	1,311	1,353	1,392	1,436	1,631	1,773
		Polished Aluminum	1,145	1,205	1,247	1,271	1,313	1,357	1,397	1,439	1,478	1,522	1,717	1,859

OPTIONS

- GD04 Glides \$26
- STC02 Soft Tread Casters \$26
- J01 Jury Base (black only) \$150





All shipments for this series will be cartoned as standard. If blanket-wrapped shipping is required, please contact client services for additional information.

NOTION

Swivel-Tilt with Tilt Lock Mechanism

ORDERING REQUIREMENTS:

- Model number
- Arm cap finish, as applicable
- Base finish
- Upholstery selection
- Options, as applicable

MODEL	PRODUCT SPECIFICATIONS	BASE FINISH	FABRIC GRADES								LEATHER			
			COM	A	1	2	3	4	COL 5	6	7	8	L1	L2
4251-M 	Mid-Back, Armless 20" W x 23.5" D x 40" - 44" H Seat: 20" W x 18.5" D Seat Ht: 17" - 21" Back: 20" W x 24" H COM: 1.75 yds. COL: 35 sq. ft. 41 lbs.	Black Nylon	895	965	1,014	1,042	1,091	1,142	1,189	1,238	1,284	1,335	1,562	1,728
		Polished Aluminum	974	1,044	1,093	1,121	1,170	1,221	1,268	1,317	1,363	1,414	1,641	1,807
4253-M 	Mid-Back, Adjustable T-Arms 26" W x 23.5" D x 40" - 44" H Seat: 20" W x 18.5" D Seat Ht: 17" - 21" Back: 20" W x 24" H COM: 1.75 yds. COL: 35 sq. ft. 43 lbs.	Black Nylon	961	1,031	1,080	1,108	1,157	1,208	1,255	1,304	1,350	1,401	1,628	1,794
		Polished Aluminum	1,040	1,110	1,159	1,187	1,236	1,287	1,334	1,383	1,429	1,480	1,707	1,873
4254-M-U 	Mid-Back, Fixed Aluminum Arms, Black Urethane Arm Caps 24.5" W x 23.5" D x 40" - 44" H Seat: 20" W x 18.5" D Seat Ht: 17" - 21" Back: 20" W x 24" H COM: 1.75 yds. COL: 35 sq. ft. 43 lbs.	Black Nylon	1,081	1,151	1,200	1,228	1,277	1,328	1,375	1,424	1,470	1,521	1,748	1,914
		Polished Aluminum	1,160	1,230	1,279	1,307	1,356	1,407	1,454	1,503	1,549	1,600	1,827	1,993
4254-M-W 	Mid-Back, Fixed Aluminum Arms, Beech Wood Arm Caps 24.5" W x 23.5" D x 40" - 44" H Seat: 20" W x 18.5" D Seat Ht: 17" - 21" Back: 20" W x 24" H COM: 1.75 yds. COL: 31.5 sq. ft. 43 lbs.	Black Nylon	1,081	1,151	1,200	1,228	1,277	1,328	1,375	1,424	1,470	1,521	1,748	1,914
		Polished Aluminum	1,167	1,237	1,286	1,314	1,363	1,414	1,461	1,510	1,556	1,607	1,834	2,000

OPTIONS

- GD04 Glides \$26
- STC02 Soft Tread Casters \$26
- J01 Jury Base (black only) \$150





All shipments for this series will be cartoned as standard. If blanket-wrapped shipping is required, please contact client services for additional information.

NOTION

Swivel-Tilt with Tilt Lock Mechanism

ORDERING REQUIREMENTS:

- Model number
- Arm cap finish, as applicable
- Base finish
- Upholstery selection
- Options, as applicable

MODEL	PRODUCT SPECIFICATIONS	BASE FINISH	FABRIC GRADES								LEATHER			
			COM	A	1	2	3	4	COL 5	6	7	8	L1	L2
4251-H 	High Back, Armless 20" W x 23.5" D x 46" - 50" H Seat: 20" W x 18.5" D Seat Ht: 17" - 21" Back: 20" W x 30" H COM: 2 yds. COL: 40 sq. ft. 42 lbs.	Black Nylon	927	1,007	1,063	1,095	1,151	1,209	1,263	1,319	1,371	1,429	1,689	1,879
		Polished Aluminum	1,006	1,086	1,142	1,174	1,230	1,288	1,342	1,398	1,450	1,508	1,768	1,958
4253-H 	High Back, Adjustable T-Arms 26" W x 23.5" D x 46" - 50" H Seat: 20" W x 18.5" D Seat Ht: 17" - 21" Back: 20" W x 30" H COM: 2 yds. COL: 40 sq. ft. 44 lbs.	Black Nylon	996	1,076	1,132	1,164	1,220	1,278	1,332	1,388	1,440	1,498	1,758	1,948
		Polished Aluminum	1,075	1,155	1,211	1,243	1,299	1,357	1,411	1,467	1,519	1,577	1,837	2,027
4254-H-U 	High Back, Fixed Aluminum Arms, Black Urethane Arm Caps 24.5" W x 23.5" D x 46" - 50" H Seat: 20" W x 18.5" D Seat Ht: 17" - 21" Back: 20" W x 30" H COM: 2 yds. COL: 40 sq. ft. 44 lbs.	Black Nylon	1,115	1,195	1,251	1,283	1,339	1,397	1,451	1,507	1,559	1,617	1,877	2,067
		Polished Aluminum	1,194	1,274	1,330	1,362	1,418	1,476	1,530	1,586	1,638	1,696	1,956	2,146
4254-H-W 	High Back, Fixed Aluminum Arms, Beech Wood Arm Caps 24.5" W x 23.5" D x 46" - 50" H Seat: 20" W x 18.5" D Seat Ht: 17" - 21" Back: 20" W x 30" H COM: 2 yds. COL: 40 sq. ft. 44 lbs.	Black Nylon	1,115	1,195	1,251	1,283	1,339	1,397	1,451	1,507	1,559	1,617	1,877	2,067
		Polished Aluminum	1,201	1,281	1,337	1,369	1,425	1,483	1,537	1,593	1,645	1,703	1,963	2,153

OPTIONS

- GD04 Glides \$26
- STC02 Soft Tread Casters \$26
- J01 Jury Base (black only) \$150





All shipments for this series will be cartoned as standard. If blanket-wrapped shipping is required, please contact client services for additional information.

NOTION

Multi-Lever Mechanism

ORDERING REQUIREMENTS:

- Model number
- Arm cap finish, as applicable
- Base finish
- Upholstery selection
- Options, as applicable

MODEL	PRODUCT SPECIFICATIONS	BASE FINISH	FABRIC GRADES								LEATHER			
			COM	A	1	2	3	4	COL 5	6	7	8	L1	L2
4261-L 	Low Back Stool, Armless 20" W x 23.5" D x 38.5" - 45" H Seat: 20" W x 18.5" D Seat Ht: 22" - 30" Back: 19.5" W x 19" - 21.5" H COM: 1.5 yds. COL: 30 sq. ft. 43 lbs.	Black Nylon	1,018	1,078	1,120	1,144	1,186	1,230	1,270	1,312	1,351	1,395	1,590	1,732
		Polished Aluminum	1,097	1,157	1,199	1,223	1,265	1,309	1,349	1,391	1,430	1,474	1,669	1,811
4263-L 	Low Back Stool, Adjustable T-Arms 26" W x 23.5" D x 38.5" - 45" H Seat: 20" W x 18.5" D Seat Ht: 22" - 30" Back: 19.5" W x 19" - 21.5" H COM: 1.5 yds. COL: 30 sq. ft. 45 lbs.	Black Nylon	1,088	1,148	1,190	1,214	1,256	1,300	1,340	1,382	1,421	1,465	1,660	1,802
		Polished Aluminum	1,167	1,227	1,269	1,293	1,335	1,379	1,419	1,461	1,500	1,544	1,739	1,881
4264-L-U 	Low Back Stool, Fixed Aluminum Arms, Black Urethane Arm Caps 24.5" W x 23.5" D x 38.5" - 45" H Seat: 20" W x 18.5" D Seat Ht: 22" - 30" Back: 19.5" W x 19" - 21.5" H COM: 1.5 yds. COL: 30 sq. ft. 45 lbs.	Black Nylon	1,207	1,267	1,309	1,333	1,375	1,419	1,459	1,501	1,540	1,584	1,779	1,921
		Polished Aluminum	1,286	1,346	1,388	1,412	1,454	1,498	1,538	1,580	1,619	1,663	1,858	2,000
4264-L-W 	Low Back Stool, Fixed Aluminum Arms, Beech Wood Arm Caps 24.5" W x 23.5" D x 38.5" - 45" H Seat: 20" W x 18.5" D Seat Ht: 22" - 30" Back: 19.5" W x 19" - 21.5" H COM: 1.5 yds. COL: 30 sq. ft. 45 lbs.	Black Nylon	1,207	1,267	1,309	1,333	1,375	1,419	1,459	1,501	1,540	1,584	1,779	1,921
		Polished Aluminum	1,293	1,353	1,395	1,419	1,461	1,505	1,545	1,587	1,626	1,670	1,865	2,007

OPTIONS

- GD04 Glides \$26
- STC02 Soft Tread Casters \$26





All shipments for this series will be cartoned as standard. If blanket-wrapped shipping is required, please contact client services for additional information.

NOTION

Synchro Knee-Tilt Mechanism

ORDERING REQUIREMENTS:

- Model number
- Arm cap finish, as applicable
- Base finish
- Upholstery selection
- Options, as applicable

MODEL	PRODUCT SPECIFICATIONS	BASE FINISH	FABRIC GRADES								LEATHER			
			COM	A	1	2	3	4	COL 5	6	7	8	L1	L2
4281-M 	Mid-Back, Armless 20" W x 23.5" D x 40" - 43" H Seat: 20" W x 18.5" D Seat Ht: 17" - 20" Back: 20" W x 24" H COM: 1.75 yds. COL: 35 sq. ft. 48 lbs.	Black Nylon	1,083	1,153	1,202	1,230	1,279	1,330	1,377	1,426	1,472	1,523	1,750	1,916
		Polished Aluminum	1,162	1,232	1,281	1,309	1,358	1,409	1,456	1,505	1,551	1,602	1,829	1,995
4283-M 	Mid-Back, Adjustable T-Arms 26" W x 23.5" D x 40" - 43" H Seat: 20" W x 18.5" D Seat Ht: 17" - 20" Back: 20" W x 24" H COM: 1.75 yds. COL: 35 sq. ft. 50 lbs.	Black Nylon	1,151	1,221	1,270	1,298	1,347	1,398	1,445	1,494	1,540	1,591	1,818	1,984
		Polished Aluminum	1,230	1,300	1,349	1,377	1,426	1,477	1,524	1,573	1,619	1,670	1,897	2,063
4284-M-U 	Mid-Back, Fixed Aluminum Arms, Black Urethane Arm Caps 24.5" W x 23.5" D x 40" - 43" H Seat: 20" W x 18.5" D Seat Ht: 17" - 20" Back: 20" W x 24" H COM: 1.75 yds. COL: 35 sq. ft. 50 lbs.	Black Nylon	1,272	1,342	1,391	1,419	1,468	1,519	1,566	1,615	1,661	1,712	1,939	2,105
		Polished Aluminum	1,351	1,421	1,470	1,498	1,547	1,598	1,645	1,694	1,740	1,791	2,018	2,184
4284-M-W 	Mid-Back, Fixed Aluminum Arms, Beech Wood Arm Caps 24.5" W x 23.5" D x 40" - 43" H Seat: 20" W x 18.5" D Seat Ht: 17" - 20" Back: 20" W x 24" H COM: 1.75 yds. COL: 35 sq. ft. 50 lbs.	Black Nylon	1,272	1,342	1,391	1,419	1,468	1,519	1,566	1,615	1,661	1,712	1,939	2,105
		Polished Aluminum	1,358	1,428	1,477	1,505	1,554	1,605	1,652	1,701	1,747	1,798	2,025	2,191

OPTIONS

- GD04 Glides \$26
- STC02 Soft Tread Casters \$26
- J01 Jury Base (black only) \$150





All shipments for this series will be cartoned as standard. If blanket-wrapped shipping is required, please contact client services for additional information.

NOTION

Synchro Knee-Tilt Mechanism

ORDERING REQUIREMENTS:

- Model number
- Arm cap finish, as applicable
- Base finish
- Upholstery selection
- Options, as applicable

MODEL	PRODUCT SPECIFICATIONS	BASE FINISH	FABRIC GRADES								LEATHER			
			COM	A	1	2	3	4	COL 5	6	7	8	L1	L2
4281-H 	High Back, Armless 20" W x 23.5" D x 46" - 49" H Seat: 20" W x 18.5" D Seat Ht: 17" - 20" Back: 20" W x 30" H COM: 2 yds. COL: 40 sq. ft. 49 lbs.	Black Nylon	1,113	1,193	1,249	1,281	1,337	1,395	1,449	1,505	1,557	1,615	1,875	2,065
		Polished Aluminum	1,192	1,272	1,328	1,360	1,416	1,474	1,528	1,584	1,636	1,694	1,954	2,144
4283-H 	High Back, Adjustable T-Arms 26" W x 23.5" D x 46" - 49" H Seat: 20" W x 18.5" D Seat Ht: 17" - 20" Back: 20" W x 30" H COM: 2 yds. COL: 40 sq. ft. 51 lbs.	Black Nylon	1,184	1,264	1,320	1,352	1,408	1,466	1,520	1,576	1,628	1,686	1,946	2,136
		Polished Aluminum	1,263	1,343	1,399	1,431	1,487	1,545	1,599	1,655	1,707	1,765	2,025	2,215
4284-H-U 	High Back, Fixed Aluminum Arms, Black Urethane Arm Caps 24.5" W x 23.5" D x 46" - 49" H Seat: 20" W x 18.5" D Seat Ht: 17" - 20" Back: 20" W x 30" H COM: 2 yds. COL: 40 sq. ft. 51 lbs.	Black Nylon	1,304	1,384	1,440	1,472	1,528	1,586	1,640	1,696	1,748	1,806	2,066	2,256
		Polished Aluminum	1,383	1,463	1,519	1,551	1,607	1,665	1,719	1,775	1,827	1,885	2,145	2,335
4284-H-W 	High Back, Fixed Aluminum Arms, Beech Wood Arm Caps 24.5" W x 23.5" D x 46" - 49" H Seat: 20" W x 18.5" D Seat Ht: 17" - 20" Back: 20" W x 30" H COM: 2 yds. COL: 40 sq. ft. 51 lbs.	Black Nylon	1,304	1,384	1,440	1,472	1,528	1,586	1,640	1,696	1,748	1,806	2,066	2,256
		Polished Aluminum	1,390	1,470	1,526	1,558	1,614	1,672	1,726	1,782	1,834	1,892	2,152	2,342

OPTIONS

- GD04 Glides \$26
- STC02 Soft Tread Casters \$26
- J01 Jury Base (black only) \$150





All shipments for this series will be cartoned as standard. If blanket-wrapped shipping is required, please contact client services for additional information.

NOTION

Synchro-Tilt Mechanism

ORDERING REQUIREMENTS:

- Model number
- Arm cap finish, as applicable
- Base finish
- Upholstery selection
- Options, as applicable

MODEL	PRODUCT SPECIFICATIONS	BASE FINISH	FABRIC GRADES										LEATHER	
			COM	A	1	2	3	4	COL 5	6	7	8	L1	L2
4291-L 	Low Back, Armless 20" W x 23.5" D x 33.5" - 37.5" H Seat: 20" W x 18.5" D Seat Ht: 17" - 21" Back: 19.5" W x 19" - 21.5" H COM: 1.5 yds. COL: 30 sq. ft. 43 lbs.	Black Nylon	919	979	1,021	1,045	1,087	1,131	1,171	1,213	1,252	1,296	1,491	1,633
		Polished Aluminum	998	1,058	1,100	1,124	1,166	1,210	1,250	1,292	1,331	1,375	1,570	1,712
4293-L 	Low Back, Adjustable T-Arms 26" W x 23.5" D x 33.5" - 37.5" H Seat: 20" W x 18.5" D Seat Ht: 17" - 21" Back: 19.5" W x 19" - 21.5" H COM: 1.5 yds. COL: 30 sq. ft. 45 lbs.	Black Nylon	987	1,047	1,089	1,113	1,155	1,199	1,239	1,281	1,320	1,364	1,559	1,701
		Polished Aluminum	1,066	1,126	1,168	1,192	1,234	1,278	1,318	1,360	1,399	1,443	1,638	1,780
4294-L-U 	Low Back, Fixed Aluminum Arms, Black Urethane Arm Caps 24.5" W x 23.5" D x 33.5" - 37.5" H Seat: 20" W x 18.5" D Seat Ht: 17" - 21" Back: 19.5" W x 19" - 21.5" H COM: 1.5 yds. COL: 30 sq. ft. 45 lbs.	Black Nylon	1,107	1,167	1,209	1,233	1,275	1,319	1,359	1,401	1,440	1,484	1,679	1,821
		Polished Aluminum	1,186	1,246	1,288	1,312	1,354	1,398	1,438	1,480	1,519	1,563	1,758	1,900
4294-L-W 	Low Back, Fixed Aluminum Arms, Beech Wood Arm Caps 24.5" W x 23.5" D x 33.5" - 37.5" H Seat: 20" W x 18.5" D Seat Ht: 17" - 21" Back: 19.5" W x 19" - 21.5" H COM: 1.5 yds. COL: 30 sq. ft. 45 lbs.	Black Nylon	1,107	1,167	1,209	1,233	1,275	1,319	1,359	1,401	1,440	1,484	1,679	1,821
		Polished Aluminum	1,193	1,253	1,295	1,319	1,361	1,405	1,445	1,487	1,526	1,570	1,765	1,907

OPTIONS

-GD04	Glides	\$26
-STC02	Soft Tread Casters	\$26
-J01	Jury Base (black only)	\$150





All shipments for this series will be cartoned as standard. If blanket-wrapped shipping is required, please contact client services for additional information.

NOTION

Synchro-Tilt Mechanism

ORDERING REQUIREMENTS:

- Model number
- Arm cap finish, as applicable
- Base finish
- Upholstery selection
- Options, as applicable

MODEL	PRODUCT SPECIFICATIONS	BASE FINISH	FABRIC GRADES								LEATHER			
			COM	A	1	2	3	4	COL 5	6	7	8	L1	L2
 4291-M	Mid-Back, Armless 20" W x 23.5" D x 40" - 44" H Seat: 20" W x 18.5" D Seat Ht: 17" - 21" Back: 20" W x 24" H COM: 1.75 yds. COL: 35 sq. ft. 44 lbs.	Black Nylon	945	1,015	1,064	1,092	1,141	1,192	1,239	1,288	1,334	1,385	1,612	1,778
		Polished Aluminum	1,024	1,094	1,143	1,171	1,220	1,271	1,318	1,367	1,413	1,464	1,691	1,857
 4293-M	Mid-Back, Adjustable T-Arms 26" W x 23.5" D x 40" - 44" H Seat: 20" W x 18.5" D Seat Ht: 17" - 21" Back: 20" W x 24" H COM: 1.75 yds. COL: 35 sq. ft. 46 lbs.	Black Nylon	1,011	1,081	1,130	1,158	1,207	1,258	1,305	1,354	1,400	1,451	1,678	1,844
		Polished Aluminum	1,090	1,160	1,209	1,237	1,286	1,337	1,384	1,433	1,479	1,530	1,757	1,923
 4294-M-U	Mid-Back, Fixed Aluminum Arms, Black Urethane Arm Caps 24.5" W x 23.5" D x 40" - 44" H Seat: 20" W x 18.5" D Seat Ht: 17" - 21" Back: 20" W x 24" H COM: 1.75 yds. COL: 35 sq. ft. 46 lbs.	Black Nylon	1,129	1,199	1,248	1,276	1,325	1,376	1,423	1,472	1,518	1,569	1,796	1,962
		Polished Aluminum	1,208	1,278	1,327	1,355	1,404	1,455	1,502	1,551	1,597	1,648	1,875	2,041
 4294-M-W	Mid-Back, Fixed Aluminum Arms, Beech Wood Arm Caps 24.5" W x 23.5" D x 40" - 44" H Seat: 20" W x 18.5" D Seat Ht: 17" - 21" Back: 20" W x 24" H COM: 1.75 yds. COL: 35 sq. ft. 46 lbs.	Black Nylon	1,129	1,199	1,248	1,276	1,325	1,376	1,423	1,472	1,518	1,569	1,796	1,962
		Polished Aluminum	1,215	1,285	1,334	1,362	1,411	1,462	1,509	1,558	1,604	1,655	1,882	2,048

OPTIONS

- GD04 Glides \$26
- STC02 Soft Tread Casters \$26
- J01 Jury Base (black only) \$150





All shipments for this series will be cartoned as standard. If blanket-wrapped shipping is required, please contact client services for additional information.

NOTION

Synchro-Tilt Mechanism

ORDERING REQUIREMENTS:

- Model number
- Arm cap finish, as applicable
- Base finish
- Upholstery selection
- Options, as applicable

MODEL	PRODUCT SPECIFICATIONS	BASE FINISH	FABRIC GRADES								LEATHER			
			COM	A	1	2	3	4	COL 5	6	7	8	L1	L2
4291-H 	High Back, Armless 20" W x 23.5" D x 46" - 50" H Seat: 20" W x 18.5" D Seat Ht: 17" - 21" Back: 20" W x 30" H COM: 2 yds. COL: 40 sq. ft. 45 lbs.	Black Nylon	980	1,060	1,116	1,148	1,204	1,262	1,316	1,372	1,424	1,482	1,742	1,932
		Polished Aluminum	1,059	1,139	1,195	1,227	1,283	1,341	1,395	1,451	1,503	1,561	1,821	2,011
4293-H 	High Back, Adjustable T-Arms 26" W x 23.5" D x 46" - 50" H Seat: 20" W x 18.5" D Seat Ht: 17" - 21" Back: 20" W x 30" H COM: 2 yds. COL: 40 sq. ft. 47 lbs.	Black Nylon	1,047	1,127	1,183	1,215	1,271	1,329	1,383	1,439	1,491	1,549	1,809	1,999
		Polished Aluminum	1,126	1,206	1,262	1,294	1,350	1,408	1,462	1,518	1,570	1,628	1,888	2,078
4294-H-U 	High Back, Fixed Aluminum Arms, Black Urethane Arm Caps 24.5" W x 23.5" D x 46" - 50" H Seat: 20" W x 18.5" D Seat Ht: 17" - 21" Back: 20" W x 30" H COM: 2 yds. COL: 40 sq. ft. 47 lbs.	Black Nylon	1,167	1,247	1,303	1,335	1,391	1,449	1,503	1,559	1,611	1,669	1,929	2,119
		Polished Aluminum	1,246	1,326	1,382	1,414	1,470	1,528	1,582	1,638	1,690	1,748	2,008	2,198
4294-H-W 	High Back, Fixed Aluminum Arms, Beech Wood Arm Caps 24.5" W x 23.5" D x 46" - 50" H Seat: 20" W x 18.5" D Seat Ht: 17" - 21" Back: 20" W x 30" H COM: 2 yds. COL: 40 sq. ft. 47 lbs.	Black Nylon	1,167	1,247	1,303	1,335	1,391	1,449	1,503	1,559	1,611	1,669	1,929	2,119
		Polished Aluminum	1,253	1,333	1,389	1,421	1,477	1,535	1,589	1,645	1,697	1,755	2,015	2,205

OPTIONS

- GD04 Glides \$26
- STC02 Soft Tread Casters \$26
- J01 Jury Base (black only) \$150

OLÉ GUEST | Designed by Ximo Roca

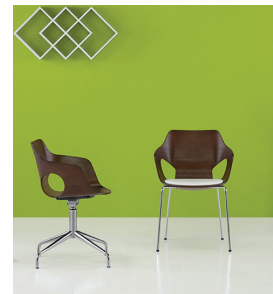

SPECIFICATIONS:

- Polypropylene and wood shell models available with or without upholstered seat pads.
- Polypropylene available in 5 colors. Please refer to listing below.
- Two wood species available: Beech and White Oak.
- Available in all standard wood finishes. Please refer to standard finish card.
- Two base options available: 4-leg base or swivel base.
- Bases offered in standard and premium finishes. Please refer to listing below.
- 4-leg base models stack up to 5-high standing.
- 300 lb. weight capacity.
- All dimensions are nominal.
- Refer to terms and conditions for general information regarding fabrics, finishes, warranty, freight, complete condition of sales and more.

STANDARD METAL BASE FINISH COLORS:

- #06 Charcoal Grey
- #90 Metallic Silver
- #91 Chrome (4-leg base only)
- #92 Polished Aluminum (swivel base only)
- #95 Satin Black

PREMIUM METAL BASE FINISH COLORS:

- #07 Gold Shimmer
- #08 Penny
- #09 Brown Sugar
- #83 Metallic Champagne
- #94 Cotton

POLYPROPYLENE COLORS:

- #127 Simply White
- #128 Carbon
- #129 Pebble

All shipments for this series will be blanket-wrapped as standard. If cartoning is required, a 5% upcharge will be added to each product. Please contact client services for additional information.



OLÉ GUEST | Designed by Ximo Roca



*Quick-Time finishes are limited to #90 Metallic Silver and #91 Chrome on 4-leg base models and #92 Polished Aluminum on swivel base models.

ORDERING REQUIREMENTS:

- Model number
- Poly color
- Base finish
- Options, as applicable

MODEL	PRODUCT SPECIFICATIONS	LIST
<p>15121-P</p> 	<p>Guest Chair, Poly Shell, 4-Leg Base</p> <p>23.5" W x 21" D x 31" H Seat: 20" W x 16" D Seat Ht: 18" Back: 15" W x 14" H 11 lbs.</p>	382
<p>15123-P</p> 	<p>Guest Chair, Poly Shell, Swivel Base</p> <p>23.5" W x 21" D x 31" H Seat: 20" W x 16" D Seat Ht: 18" Back: 15" W x 14" H 15 lbs.</p>	818

OPTIONS

-PF02 Premium Metal Base Finish \$80

All shipments for this series will be blanket-wrapped as standard. If cartoning is required, a 5% upcharge will be added to each product. Please contact client services for additional information.



OLÉ GUEST | Designed by Ximo Roca



*Quick-Time finishes are limited to #90 Metallic Silver and #91 Chrome on 4-leg base models and #92 Polished Aluminum on swivel base models.

ORDERING REQUIREMENTS:

- Model number
- Poly color
- Base finish
- Upholstery selection
- Options, as applicable

MODEL	PRODUCT SPECIFICATIONS	FABRIC GRADES										LEATHER	
		COM	A	1	2	3	4	COL 5	6	7	8	L1	L2
15121-P-SU 	Guest Chair, Poly Shell with Upholstered Seat Pad, 4-Leg Base 23.5" W x 21" D x 31" H Seat: 20" W x 16" D Seat Ht: 18.25" Back: 15" W x 14" H COM: .5 yd. COL: 10 sq. ft. 12 lbs.	436	456	470	478	492	507	520	534	547	562	627	674
15123-P-SU 	Guest Chair, Poly Shell with Upholstered Seat Pad, Swivel Base 23.5" W x 21" D x 31" H Seat: 20" W x 16" D Seat Ht: 18.25" Back: 15" W x 14" H COM: .5 yd. COL: 10 sq. ft. 16 lbs.	868	888	902	910	924	939	952	966	979	994	1,059	1,106

OPTIONS



-PF02 Premium Metal Base Finish \$80

All shipments for this series will be blanket-wrapped as standard. If cartoning is required, a 5% upcharge will be added to each product. Please contact client services for additional information.

OLÉ GUEST | Designed by Ximo Roca

ORDERING REQUIREMENTS:

- Model number
- Wood finish
- Base finish
- Options, as applicable

MODEL	PRODUCT SPECIFICATIONS	LIST
15121-W 	Guest Chair, Wood Shell, 4-Leg Base 21.75" W x 21.5" D x 31" H Seat: 20" W x 16" D Seat Ht: 18" 13 lbs.	696
15123-W 	Guest Chair, Wood Shell, Swivel Base 21.75" W x 21.5" D x 31" H Seat: 20" W x 16" D Seat Ht: 18" 17 lbs.	1,161

OPTIONS



-PF02 Premium Metal Base Finish \$80

All shipments for this series will be blanket-wrapped as standard. If cartoning is required, a 5% upcharge will be added to each product. Please contact client services for additional information.

OLÉ GUEST | Designed by Ximo Roca

ORDERING REQUIREMENTS:

- Model number
- Wood finish
- Base finish
- Upholstery selection
- Options, as applicable

MODEL	PRODUCT SPECIFICATIONS	FABRIC GRADES								LEATHER			
		COM	A	1	2	3	4	COL 5	6	7	8	L1	L2
15121-W-SU 	Guest Chair, Wood Shell with Upholstered Seat Pad, 4-Leg Base 21.75" W x 21.5" D x 31" H Seat: 20" W x 16" D Seat Ht: 18.25" COM: .5 yd. COL: 10 sq. ft. 14 lbs. TB 133: \$25	750	770	784	792	806	821	834	848	861	876	941	988
15123-W-SU 	Guest Chair, Wood Shell with Upholstered Seat Pad, Swivel Base 21.75" W x 21.5" D x 31" H Seat: 20" W x 16" D Seat Ht: 18.25" COM: .5 yd. COL: 10 sq. ft. 18 lbs. TB 133: \$25	1,210	1,230	1,244	1,252	1,266	1,281	1,294	1,308	1,321	1,336	1,401	1,448

OPTIONS

-PF02 Premium Metal Base Finish \$80

PARTICLES MODULAR | Designed by Chris Panichella



PRODUCT FEATURES:

- Modular bench and table system available in a variety of widths and heights.
- Upholstered side panels feature horizontal and vertical welt detailing.
- For maximum visual appeal, optional contrasting welt is recommended. Please see specific product pages for yardage requirements and pricing.
- Each unit comes standard with three black glides.
- Non-skid glides also available for hard surface floors. Please specify “-NS02C” after model number and add \$42 List per unit, or as noted.
- Optional power units available.
- All dimensions are nominal.
- Refer to terms and conditions for general information regarding fabrics, finishes, warranty, freight, complete condition of sales and more.

MODULAR BENCHES:

- Triangular-shaped benches taper inward or outward to adjoin with each other and accompanying tables fluidly.
- Available in 20”, 28” and 36” widths (point-to-point dimension) with 18” seated height.
- Outward tapering benches feature a 4.5” narrower top than inward tapering versions.
- Stand-alone perching bench also available.
- 500 lb. weight capacity.

MODULAR TABLES:

- Wood veneer, laminate and solid surface top options with fully upholstered side panels.
- Three wood species available: beech, white oak and walnut.
- For standard wood and laminate options, please refer to standard finish card.
- For custom wood finishes, please add \$450 List per color per order.
- For custom laminate options, add \$550 List per color per order. Pre-approval required, please contact client services.
- Solid surface available in white only. To order a non-standard solid surface color, please specify the manufacturer, pattern name and color number. Contact client services to confirm pricing.
- All top surfaces feature an exposed wood edge with clear coat finish as standard.
- Three available widths: 20”, 28” and 36” (point-to-point dimension).
- Offered in 17” and 25” heights.
- Tables taper outward to adjoin with accompanying modular benches.

PARTICLES MODULAR | Designed by Chris Panichella

POWER BAND UNITS:

- Available on all modular tables and benches.
- Dimensions: 5.75" L x 2.5" W
- Metallic silver and white finish options.
- 108" electrical cord.
- Tables: placement will be in center of table-top unless specified otherwise.
- Benches: placement will be on side panel.
- UL listed.

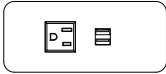

Power Band 1 (PB1):

- One outlet and two USB charging ports.

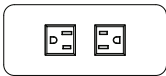

Power Band 2 (PB2):

- Two outlets.

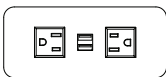

Power Band 3 (PB3):

- One outlet and two USB charging ports.
- Two outlets and two USB charging ports.

POWER ROUND UNITS:

- Available on modular tables only.
- Dimensions: 5.25" Dia.
- Metallic silver finish.
- 108" electrical cord.
- Placement will be in center of table-top unless specified otherwise.
- UL listed.

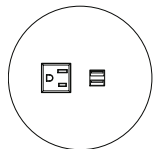

Power Round 1 (PR1):

- One outlet and two USB charging ports.

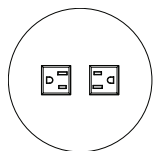

Power Round 2 (PR2):

- Two outlets.

POWER DOME UNITS:

- Available on modular tables only.
- Dimensions: 3.75" Dia. x 1.5" H
- Gloss white plastic finish.
- 72" electrical cord.
- Placement will be in center of table-top unless specified otherwise.
- UL listed.



Power Dome 1 (PD1):

- Two outlets and two USB charging ports.



Power Dome 3 (PD3):



- Three outlets.

All shipments for this series will be blanket-wrapped as standard. If cartoning is required, a 5% upcharge will be added to each product. Please contact client services for additional information.

PARTICLES MODULAR | Designed by Chris Panichella

ORDERING REQUIREMENTS:

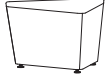
- Model number
- Seat upholstery
- Side panel upholstery
- Welt upholstery
- Options, as applicable

MODEL	PRODUCT SPECIFICATIONS	FABRIC GRADES								LEATHER			
		COM	A	1	2	3	4	COL 5	6	7	8	L1	L2
1320 	20" Modular Bench, Inward Taper Overall: 20.5" W x 18" D x 18" H Seat: 20.5" W x 18" D COM: 1.75 yds. COL: 35 sq. ft. 15 lbs.	681	751	800	828	877	928	975	1,024	1,070	1,121	1,348	1,514
1328 	28" Modular Bench, Inward Taper Overall: 28.5" W x 25" D x 18" H Seat: 28.5" W x 25" D COM: 2.75 yds. COL: 55 sq. ft. 21 lbs.	834	944	1,021	1,065	1,142	1,222	1,296	1,373	1,445	1,525	1,882	2,143
1336 	36" Modular Bench, Inward Taper Overall: 36.5" W x 32" D x 18" H Seat: 36.5" W x 32" D COM: 3 yds. COL: 60 sq. ft. 33 lbs.	996	1,116	1,200	1,248	1,332	1,419	1,500	1,584	1,662	1,749	2,139	2,424
XXXX-CW	Contrasting Welt COM: 1 yd. COL: n/a	42	82	110	126	154	183	210	238	264	293	n/a	n/a

OPTIONS



-MB01	Moisture Barrier (seat only)	\$52
-NS04	Non-Skid Glides	\$42
-PB1-S	Power Band 1 (1 power, 2 USB), Silver	\$430
-PB1-W	Power Band 1 (1 power, 2 USB), White	\$430
-PB2-S	Power Band 2 (2 power), Silver	\$340
-PB2-W	Power Band 2 (2 power), White	\$340
-PB3-S	Power Band 3 (2 power, 2 USB), Silver	\$450
-PB3-W	Power Band 3 (2 power, 2 USB), White	\$450

All shipments for this series will be blanket-wrapped as standard. If cartoning is required, a 5% upcharge will be added to each product. Please contact client services for additional information.

PARTICLES MODULAR | Designed by Chris Panichella

ORDERING REQUIREMENTS:

- Model number
- Seat upholstery
- Side panel upholstery
- Welt upholstery
- Options, as applicable

MODEL	PRODUCT SPECIFICATIONS	FABRIC GRADES								LEATHER			
		COM	A	1	2	3	4	COL 5	6	7	8	L1	L2
1321 	20" Modular Bench, Outward Taper Overall: 20.5" W x 18" D x 18" H Seat: 16" W x 14" D COM: 1.75 yds. COL: 35 sq. ft. 15 lbs.	681	751	800	828	877	928	975	1,024	1,070	1,121	1,348	1,514
1329 	28" Modular Bench, Outward Taper Overall: 28.5" W x 25" D x 18" H Seat: 24" W x 21" D COM: 2.75 yds. COL: 55 sq. ft. 21 lbs.	834	944	1,021	1,065	1,142	1,222	1,296	1,373	1,445	1,525	1,882	2,143
1337 	36" Modular Bench, Outward Taper Overall: 36.5" W x 32" D x 18" H Seat: 31.5" W x 28" D COM: 3 yds. COL: 60 sq. ft. 33 lbs.	996	1,116	1,200	1,248	1,332	1,419	1,500	1,584	1,662	1,749	2,139	2,424
XXXX-CW	Contrasting Welt COM: 1 yd. COL: n/a	42	82	110	126	154	183	210	238	264	293	n/a	n/a

OPTIONS

-MB01	Moisture Barrier (seat only)	\$52
-NS04	Non-Skid Glides	\$42
-PB1-S	Power Band 1 (1 power, 2 USB), Silver	\$430
-PB1-W	Power Band 1 (1 power, 2 USB), White	\$430
-PB2-S	Power Band 2 (2 power), Silver	\$340
-PB2-W	Power Band 2 (2 power), White	\$340
-PB3-S	Power Band 3 (2 power, 2 USB), Silver	\$450
-PB3-W	Power Band 3 (2 power, 2 USB), White	\$450

All shipments for this series will be blanket-wrapped as standard. If cartoning is required, a 5% upcharge will be added to each product. Please contact client services for additional information.

PARTICLES MODULAR | Designed by Chris Panichella

ORDERING REQUIREMENTS:

- Model number
- Seat upholstery
- Side panel upholstery
- Welt upholstery
- Options, as applicable

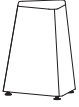
MODEL	PRODUCT SPECIFICATIONS	FABRIC GRADES								LEATHER			
		COM	A	1	2	3	4	COL 5	6	7	8	L1	L2
1322 	20" Perching Bench, Outward Taper Overall: 20.5" W x 18" D x 25" H Seat: 13" W x 12" D COM: 2.75 yds. COL: 55 sq. ft. 15 lbs.	743	853	930	974	1,051	1,131	1,205	1,282	1,354	1,434	1,791	2,052
XXXX-CW	Contrasting Welt COM: 1 yd. COL: n/a	42	82	110	126	154	183	210	238	264	293	n/a	n/a

OPTIONS



-MB01	Moisture Barrier (seat only)	\$52
-NS04	Non-Skid Glides	\$42
-PB1-S	Power Band 1 (1 power, 2 USB), Silver	\$430
-PB1-W	Power Band 1 (1 power, 2 USB), White	\$430
-PB2-S	Power Band 2 (2 power), Silver	\$340
-PB2-W	Power Band 2 (2 power), White	\$340
-PB3-S	Power Band 3 (2 power, 2 USB), Silver	\$450
-PB3-W	Power Band 3 (2 power, 2 USB), White	\$450

All shipments for this series will be blanket-wrapped as standard. If cartoning is required, a 5% upcharge will be added to each product. Please contact client services for additional information.

PARTICLES MODULAR | Designed by Chris Panichella

ORDERING REQUIREMENTS:

- Model number
- Top finish
- Side panel upholstery
- Welt upholstery
- Options, as applicable

MODEL	PRODUCT SPECIFICATIONS	FABRIC GRADES								LEATHER			
		COM	A	1	2	3	4	COL 5	6	7	8	L1	L2
1370-2017-W 	20" W, 17" H Modular Table, Wood Top Overall: 20.5" W x 18" D x 17" H Top Surface: 15.5" W x 13.5" D COM: 1.5 yds. COL: 30 sq. ft. 15 lbs.	810	870	912	936	978	1,022	1,062	1,104	1,143	1,187	1,382	1,524
1370-2817-W 	28" W, 17" H Modular Table, Wood Top Overall: 28.5" W x 25" D x 17" H Top Surface: 23.25" W x 20.5" D COM: 2 yds. COL: 40 sq. ft. 21 lbs.	1,020	1,100	1,156	1,188	1,244	1,302	1,356	1,412	1,464	1,522	1,782	1,972
1370-3617-W 	36" W, 17" H Modular Table, Wood Top Overall: 36.5" W x 32" D x 17" H Top Surface: 31" W x 27" D COM: 2 yds. COL: 40 sq. ft. 33 lbs.	1,315	1,395	1,451	1,483	1,539	1,597	1,651	1,707	1,759	1,817	2,077	2,267
XXXX-CW	Contrasting Welt COM: 1 yd. COL: n/a	42	82	110	126	154	183	210	238	264	293	n/a	n/a

OPTIONS



-NS04	Non-Skid Glides	\$42	-PR1	Power Round 1 (1 power, 2 USB)	\$435
-PB1-S	Power Band 1 (1 power, 2 USB), Silver	\$430	-PR2	Power Round 2 (2 power)	\$345
-PB1-W	Power Band 1 (1 power, 2 USB), White	\$430	-PD1	Power Dome 1 (2 power, 2 USB)	\$410
-PB2-S	Power Band 2 (2 power), Silver	\$340	-PD3	Power Dome 3 (3 power)	\$340
-PB2-W	Power Band 2 (2 power), White	\$340			
-PB3-S	Power Band 3 (2 power, 2 USB), Silver	\$450			
-PB3-W	Power Band 3 (2 power, 2 USB), White	\$450			

All shipments for this series will be blanket-wrapped as standard. If cartoning is required, a 5% upcharge will be added to each product. Please contact client services for additional information.

PARTICLES MODULAR | Designed by Chris Panichella

ORDERING REQUIREMENTS:

- Model number
- Top finish
- Side panel upholstery
- Welt upholstery
- Options, as applicable

MODEL	PRODUCT SPECIFICATIONS	FABRIC GRADES								LEATHER			
		COM	A	1	2	3	4	COL 5	6	7	8	L1	L2
1370-2017-L 	20" W, 17" H Modular Table, Laminate Top Overall: 20.5" W x 18" D x 17" H Top Surface: 15.5" W x 13.5" D COM: 1.5 yds. COL: 30 sq. ft. 15 lbs.	748	808	850	874	916	960	1,000	1,042	1,081	1,125	1,320	1,462
1370-2817-L 	28" W, 17" H Modular Table, Laminate Top Overall: 28.5" W x 25" D x 17" H Top Surface: 23.25" W x 20.5" D COM: 2 yds. COL: 40 sq. ft. 21 lbs.	926	1,006	1,062	1,094	1,150	1,208	1,262	1,318	1,370	1,428	1,688	1,878
1370-3617-L 	36" W, 17" H Modular Table, Laminate Top Overall: 36.5" W x 32" D x 17" H Top Surface: 31" W x 27" D COM: 2 yds. COL: 40 sq. ft. 33 lbs.	1,185	1,265	1,321	1,353	1,409	1,467	1,521	1,577	1,629	1,687	1,947	2,137
XXXX-CW	Contrasting Welt COM: 1 yd. COL: n/a	42	82	110	126	154	183	210	238	264	293	n/a	n/a

OPTIONS



-NS04	Non-Skid Glides	\$42	-PR1	Power Round 1 (1 power, 2 USB)	\$435
-PB1-S	Power Band 1 (1 power, 2 USB), Silver	\$430	-PR2	Power Round 2 (2 power)	\$345
-PB1-W	Power Band 1 (1 power, 2 USB), White	\$430	-PD1	Power Dome 1 (2 power, 2 USB)	\$410
-PB2-S	Power Band 2 (2 power), Silver	\$340	-PD3	Power Dome 3 (3 power)	\$340
-PB2-W	Power Band 2 (2 power), White	\$340			
-PB3-S	Power Band 3 (2 power, 2 USB), Silver	\$450			
-PB3-W	Power Band 3 (2 power, 2 USB), White	\$450			

All shipments for this series will be blanket-wrapped as standard. If cartoning is required, a 5% upcharge will be added to each product. Please contact client services for additional information.

PARTICLES MODULAR | Designed by Chris Panichella

ORDERING REQUIREMENTS:

- Model number
- Top finish
- Side panel upholstery
- Welt upholstery
- Options, as applicable

MODEL	PRODUCT SPECIFICATIONS	FABRIC GRADES								LEATHER			
		COM	A	1	2	3	4	COL 5	6	7	8	L1	L2
1370-2017-SF 	20" W, 17" H Modular Table, Solid Surface Top Overall: 20.5" W x 18" D x 17" H Top Surface: 15.5" W x 13.5" D COM: 1.5 yds. COL: 30 sq. ft. 15 lbs.	968	1,028	1,070	1,094	1,136	1,180	1,220	1,262	1,301	1,345	1,540	1,682
1370-2817-SF 	28" W, 17" H Modular Table, Solid Surface Top Overall: 28.5" W x 25" D x 17" H Top Surface: 23.25" W x 20.5" D COM: 2 yds. COL: 40 sq. ft. 21 lbs.	1,270	1,350	1,406	1,438	1,494	1,552	1,606	1,662	1,714	1,772	2,032	2,222
1370-3617-SF 	36" W, 17" H Modular Table, Solid Surface Top Overall: 36.5" W x 32" D x 17" H Top Surface: 31" W x 27" D COM: 2 yds. COL: 40 sq. ft. 33 lbs.	1,860	1,940	1,996	2,028	2,084	2,142	2,196	2,252	2,304	2,362	2,622	2,812
XXXX-CW	Contrasting Welt COM: 1 yd. COL: n/a	42	82	110	126	154	183	210	238	264	293	n/a	n/a

OPTIONS



-NS04	Non-Skid Glides	\$42	-PR1	Power Round 1 (1 power, 2 USB)	\$435
-PB1-S	Power Band 1 (1 power, 2 USB), Silver	\$430	-PR2	Power Round 2 (2 power)	\$345
-PB1-W	Power Band 1 (1 power, 2 USB), White	\$430	-PD1	Power Dome 1 (2 power, 2 USB)	\$410
-PB2-S	Power Band 2 (2 power), Silver	\$340	-PD3	Power Dome 3 (3 power)	\$340
-PB2-W	Power Band 2 (2 power), White	\$340			
-PB3-S	Power Band 3 (2 power, 2 USB), Silver	\$450			
-PB3-W	Power Band 3 (2 power, 2 USB), White	\$450			

All shipments for this series will be blanket-wrapped as standard. If cartoning is required, a 5% upcharge will be added to each product. Please contact client services for additional information.

PARTICLES MODULAR | Designed by Chris Panichella

ORDERING REQUIREMENTS:

- Model number
- Top finish
- Side panel upholstery
- Welt upholstery
- Options, as applicable

MODEL	PRODUCT SPECIFICATIONS	FABRIC GRADES										LEATHER	
		COM	A	1	2	3	4	COL 5	6	7	8	L1	L2
1370-2025-W 	20" W, 25" H Modular Table, Wood Top Overall: 20.5" W x 18" D x 25" H Top Surface: 13" W x 11.5" D COM: 1.75 yds. COL: 35 sq. ft. 16 lbs.	870	940	989	1,017	1,066	1,117	1,164	1,213	1,259	1,310	1,537	1,703
1370-2825-W 	28" W, 25" H Modular Table, Wood Top Overall: 28.5" W x 25" D x 25" H Top Surface: 20.75" W x 18.25" D COM: 2.5 yds. COL: 50 sq. ft. 23 lbs.	1,091	1,191	1,261	1,301	1,371	1,444	1,511	1,581	1,646	1,719	2,044	2,281
1370-3625-W 	36" W, 25" H Modular Table, Wood Top Overall: 36.5" W x 32" D x 25" H Top Surface: 28.5" W x 25" D COM: 2.5 yds. COL: 50 sq. ft. 35 lbs.	1,400	1,500	1,570	1,610	1,680	1,753	1,820	1,890	1,955	2,028	2,353	2,590
XXXX-CW	Contrasting Welt COM: 1 yd. COL: n/a	42	82	110	126	154	183	210	238	264	293	n/a	n/a

OPTIONS



-NS04	Non-Skid Glides	\$42	-PR1	Power Round 1 (1 power, 2 USB)	\$435
-PB1-S	Power Band 1 (1 power, 2 USB), Silver	\$430	-PR2	Power Round 2 (2 power)	\$345
-PB1-W	Power Band 1 (1 power, 2 USB), White	\$430	-PD1	Power Dome 1 (2 power, 2 USB)	\$410
-PB2-S	Power Band 2 (2 power), Silver	\$340	-PD3	Power Dome 3 (3 power)	\$340
-PB2-W	Power Band 2 (2 power), White	\$340			
-PB3-S	Power Band 3 (2 power, 2 USB), Silver	\$450			
-PB3-W	Power Band 3 (2 power, 2 USB), White	\$450			

All shipments for this series will be blanket-wrapped as standard. If cartoning is required, a 5% upcharge will be added to each product. Please contact client services for additional information.

PARTICLES MODULAR | Designed by Chris Panichella

ORDERING REQUIREMENTS:

- Model number
- Top finish
- Side panel upholstery
- Welt upholstery
- Options, as applicable

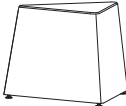
MODEL	PRODUCT SPECIFICATIONS	FABRIC GRADES								LEATHER			
		COM	A	1	2	3	4	COL 5	6	7	8	L1	L2
1370-2025-L 	20" W, 25" H Modular Table, Laminate Top Overall: 20.5" W x 18" D x 25" H Top Surface: 13" W x 11.5" D COM: 1.75 yds. COL: 35 sq. ft. 16 lbs.	807	877	926	954	1,003	1,054	1,101	1,150	1,196	1,247	1,474	1,640
1370-2825-L 	28" W, 25" H Modular Table, Laminate Top Overall: 28.5" W x 25" D x 25" H Top Surface: 20.75" W x 18.25" D COM: 2.5 yds. COL: 50 sq. ft. 23 lbs.	998	1,098	1,168	1,208	1,278	1,351	1,418	1,488	1,553	1,626	1,951	2,188
1370-3625-L 	36" W, 25" H Modular Table, Laminate Top Overall: 36.5" W x 32" D x 25" H Top Surface: 28.5" W x 25" D COM: 2.5 yds. COL: 50 sq. ft. 35 lbs.	1,270	1,370	1,440	1,480	1,550	1,623	1,690	1,760	1,825	1,898	2,223	2,460
XXXX-CW	Contrasting Welt COM: 1 yd. COL: n/a	42	82	110	126	154	183	210	238	264	293	n/a	n/a

OPTIONS



-NS04	Non-Skid Glides	\$42	-PR1	Power Round 1 (1 power, 2 USB)	\$435
-PB1-S	Power Band 1 (1 power, 2 USB), Silver	\$430	-PR2	Power Round 2 (2 power)	\$345
-PB1-W	Power Band 1 (1 power, 2 USB), White	\$430	-PD1	Power Dome 1 (2 power, 2 USB)	\$410
-PB2-S	Power Band 2 (2 power), Silver	\$340	-PD3	Power Dome 3 (3 power)	\$340
-PB2-W	Power Band 2 (2 power), White	\$340			
-PB3-S	Power Band 3 (2 power, 2 USB), Silver	\$450			
-PB3-W	Power Band 3 (2 power, 2 USB), White	\$450			

All shipments for this series will be blanket-wrapped as standard. If cartoning is required, a 5% upcharge will be added to each product. Please contact client services for additional information.

PARTICLES MODULAR | Designed by Chris Panichella

ORDERING REQUIREMENTS:

- Model number
- Top finish
- Side panel upholstery
- Welt upholstery
- Options, as applicable

MODEL	PRODUCT SPECIFICATIONS	FABRIC GRADES								LEATHER			
		COM	A	1	2	3	4	COL 5	6	7	8	L1	L2
1370-2025-SF 	20" W, 25" H Modular Table, Solid Surface Top Overall: 20.5" W x 18" D x 25" H Top Surface: 13" W x 11.5" D COM: 1.75 yds. COL: 35 sq. ft. 16 lbs. TB 133: \$88	1,027	1,097	1,146	1,174	1,223	1,274	1,321	1,370	1,416	1,467	1,694	1,860
1370-2825-SF 	28" W, 25" H Modular Table, Solid Surface Top Overall: 28.5" W x 25" D x 25" H Top Surface: 20.75" W x 18.25" D COM: 2.5 yds. COL: 50 sq. ft. 23 lbs. TB 133: \$125	1,342	1,442	1,512	1,552	1,622	1,695	1,762	1,832	1,897	1,970	2,295	2,532
1370-3625-SF 	36" W, 25" H Modular Table, Solid Surface Top Overall: 36.5" W x 32" D x 25" H Top Surface: 28.5" W x 25" D COM: 2.5 yds. COL: 50 sq. ft. 35 lbs. TB 133: \$125	1,945	2,045	2,115	2,155	2,225	2,298	2,365	2,435	2,500	2,573	2,898	3,135
XXXX-CW	Contrasting Welt COM: 1 yd. COL: n/a	42	82	110	126	154	183	210	238	264	293	n/a	n/a

OPTIONS

-NS04	Non-Skid Glides	\$42	-PR1	Power Round 1 (1 power, 2 USB)	\$435
-PB1-S	Power Band 1 (1 power, 2 USB), Silver	\$430	-PR2	Power Round 2 (2 power)	\$345
-PB1-W	Power Band 1 (1 power, 2 USB), White	\$430	-PD1	Power Dome 1 (2 power, 2 USB)	\$410
-PB2-S	Power Band 2 (2 power), Silver	\$340	-PD3	Power Dome 3 (3 power)	\$340
-PB2-W	Power Band 2 (2 power), White	\$340			
-PB3-S	Power Band 3 (2 power, 2 USB), Silver	\$450			
-PB3-W	Power Band 3 (2 power, 2 USB), White	\$450			

All shipments for this series will be blanket-wrapped as standard. If cartoning is required, a 5% upcharge will be added to each product. Please contact client services for additional information.

PARTICLES MODULAR - CONFIGURATION & ORDERING EXAMPLES

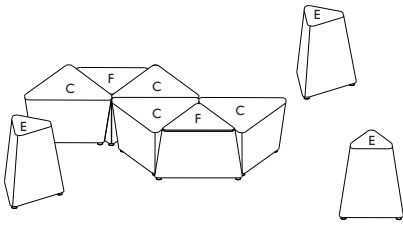

Qty	Model #	Description	COM List	Key
4	1328	28" Modular Bench, Inward Taper (\$834 List each)	\$3,336	C
3	1322	20" Perching Bench (\$743 List each)	\$2,229	E
2	1370-2817-W	28" W x 17" H Modular Table, Wood Top (\$1,020 List each)	<u>\$2,040</u>	F
			\$7,605	

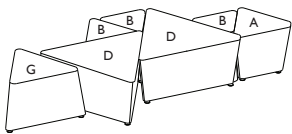

Qty	Model #	Description	COM List	Key
1	1320	20" Modular Bench, Inward Taper	\$681	A
3	1321	20" Modular Bench, Outward Taper (\$681 List each)	\$2,043	B
2	1336	36" Modular Bench, Inward Taper (\$996 List each)	\$1,992	D
1	1370-2817-L	28" W x 17" H Modular Table, Laminate Top	<u>\$926</u>	G
			\$5,642	

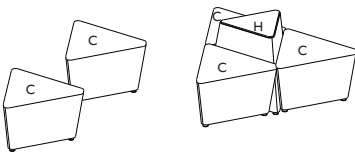

Qty	Model #	Description	COM List	Key
5	1328	28" Modular Bench, Inward Taper (\$834 List each)	\$4,170	C
1	1370-2825-SF	28" W x 25" H Modular Table, Solid Surface Top	<u>\$1,342</u>	H
			\$5,512	

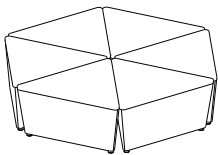

Qty	Model #	Description	COM List	Key
6	1336	36" Modular Bench, Inward Taper (\$996 List each)	\$5,976	n/a

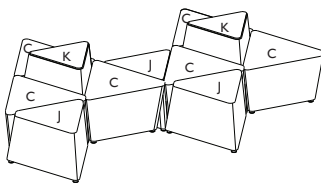

Qty	Model #	Description	COM List	Key
6	1328	28" Modular Bench, Inward Taper (\$834 List each)	\$5,004	C
3	1329	28" Modular Bench, Outward Taper (\$834 List each)	\$2,502	J
2	1370-2825-L	28" W x 25" H Modular Table, Laminate Top (\$998 List each)	<u>\$1,996</u>	K
			\$9,502	

PARTICLES MODULAR | Designed by Chris Panichella

UPHOLSTERY COMBINATIONS:

- For upholstery combinations, refer to the pricing below.
- When combining two COM/COV/COL fabrics, or fabrics with the same grade, add \$85 List per unit.
- When combining three or more COM/COV/COL fabrics, or fabrics with the same grade, add \$115 List per unit.
- When combining different grades of fabric, price will be based on the highest grade specified.
- Two-tone upholstery examples and yardage requirements for the most common combinations are listed below. Additional combinations available; please contact client Services for yardage requirements and pricing.
- Note: Yardage amounts are based on fabric which is plain (i.e. non-directional) and a full 54" wide.
- Appropriate upholstery code must be included.



Code PB1
Model [COM Requirement](#)
 1320 Seat Cushion Only = 1 yd.
 Side Panels & Welt = 1.25 yds.



Code PB2
Model [COM Requirement](#)
 1328 Seat Cushion Only = 1 yd.
 Side Panels & Welt = 1.75 yds.

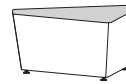

Code PB3
Model [COM Requirement](#)
 1336 Seat Cushion Only = 1.25 yds.
 Side Panels & Welt = 1.75 yds.



Code PB4
Model [COM Requirement](#)
 1321 Seat Cushion Only = 1 yd.
 Side Panels & Welt = 1.25 yds.



Code PB5
Model [COM Requirement](#)
 1329 Seat Cushion Only = 1 yd.
 Side Panels & Welt = 1.75 yds.

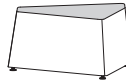

Code PB6
Model [COM Requirement](#)
 1337 Seat Cushion Only = 1.25 yds.
 Side Panels & Welt = 1.75 yds.



Code PB7
Model [COM Requirement](#)
 1322 Seat Cushion Only = 1 yd.
 Side Panels & Welt = 2.75 yds.



Code PB8
Model [COM Requirement](#)
 1320 Seat Cushion & Welt = 1 yd.
 Side Panels Only = 1.25 yds.



Code PB9
Model [COM Requirement](#)
 1328 Seat Cushion & Welt = 1 yd.
 Side Panels Only = 1.75 yds.



Code PB10
Model [COM Requirement](#)
 1336 Seat Cushion & Welt = 1.25 yds.
 Side Panels Only = 1.75 yds.



Code PB11
Model [COM Requirement](#)
 1321 Seat Cushion & Welt = 1 yd.
 Side Panels Only = 1.25 yds.



Code PB12
Model [COM Requirement](#)
 1329 Seat Cushion & Welt = 1 yd.
 Side Panels Only = 1.75 yds.



Code PB13
Model [COM Requirement](#)
 1337 Seat Cushion & Welt = 1.25 yds.
 Side Panels Only = 1.75 yds.



Code P14
Model [COM Requirement](#)
 1322 Seat Cushion & Welt = 1 yd.
 Side Panels Only = 2.75 yds.

PARTICLES JUNIOR | Designed by Chris Panichella



SPECIFICATIONS:



- Children's modular benches available in 20" and 28" widths (point-to-point dimension) with 14" seated height.
- Outward tapering benches feature a 4.5" narrower top than inward tapering versions.
- Upholstered side panels feature horizontal and vertical welt detailing.
- For maximum visual appeal, optional contrasting welt is recommended. Please see specific product pages for yardage requirements and pricing.
- Each unit comes standard with three black glides.
- Non-skid glides also available for hard surface floors. Please specify "-NS02C" after model number and add \$42 List per unit, or as noted.
- 500 lb. weight capacity.
- All dimensions are nominal.
- Refer to terms and conditions for general information regarding fabrics, finishes, warranty, freight, complete condition of sales and more.

All shipments for this series will be blanket-wrapped as standard. If cartoning is required, a 5% upcharge will be added to each product. Please contact client services for additional information.

PARTICLES JUNIOR | Designed by Chris Panichella

ORDERING REQUIREMENTS:

- Model number
- Seat upholstery
- Side panel upholstery
- Welt upholstery
- Options, as applicable

MODEL	PRODUCT SPECIFICATIONS	FABRIC GRADES								LEATHER			
		COM	A	1	2	3	4	COL 5	6	7	8	L1	L2
1340-J 	20" Modular Children's Bench, Inward Taper Overall: 20.5" W x 18" D x 14" H Seat: 20.5" W x 18" D COM: 2.5 yds. COL: 50 sq. ft. 14 lbs.	689	789	859	899	969	1,042	1,109	1,179	1,244	1,317	1,642	1,879
1348-J 	28" Modular Children's Bench, Inward Taper Overall: 28.5" W x 25" D x 14" H Seat: 28.5" W x 25" D COM: 2.75 yds. COL: 55 sq. ft. 20 lbs.	846	956	1,033	1,077	1,154	1,234	1,308	1,385	1,457	1,537	1,894	2,155
XXXX-J-CW	Contrasting Welt COM: 1 yd. COL: n/a	42	82	110	126	154	183	210	238	264	293	n/a	n/a

OPTIONS



-MB01	Moisture Barrier (seat only)	\$52
-NS04	Non-Skid Glides	\$42

All shipments for this series will be blanket-wrapped as standard. If cartoning is required, a 5% upcharge will be added to each product. Please contact client services for additional information.

PARTICLES JUNIOR | Designed by Chris Panichella

ORDERING REQUIREMENTS:

- Model number
- Seat upholstery
- Side panel upholstery
- Welt upholstery
- Options, as applicable

MODEL	PRODUCT SPECIFICATIONS	FABRIC GRADES								LEATHER			
		COM	A	1	2	3	4	COL 5	6	7	8	L1	L2
1341-J 	20" Modular Children's Bench, Outward Taper Overall: 20.5" W x 18" D x 14" H Seat: 17" W x 15" D COM: 2.5 yds. COL: 50 sq. ft. 14 lbs.	689	789	859	899	969	1,042	1,109	1,179	1,244	1,317	1,642	1,879
1349-J 	28" Modular Children's Bench, Outward Taper Overall: 28.5" W x 25" D x 14" H Seat: 24.5" W x 21.75" D COM: 2.75 yds. COL: 55 sq. ft. 20 lbs.	846	956	1,033	1,077	1,154	1,234	1,308	1,385	1,457	1,537	1,894	2,155
XXXX-J-CW	Contrasting Welt COM: 1 yd. COL: n/a	42	82	110	126	154	183	210	238	264	293	n/a	n/a

OPTIONS

- MB01 Moisture Barrier (seat only) \$52
- NS04 Non-Skid Glides \$42

All shipments for this series will be blanket-wrapped as standard. If cartoning is required, a 5% upcharge will be added to each product. Please contact client services for additional information.

PARTICLES JUNIOR - CONFIGURATION & ORDERING EXAMPLES

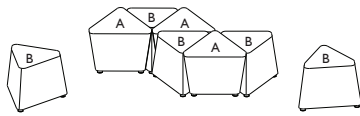

<u>Qty</u>	<u>Model #</u>	<u>Description</u>	<u>COM List</u>	<u>Key</u>
3	1340-J	20" Modular Bench, Inward Taper (\$689 List each)	\$1,968	A
5	1341-J	20" Modular Bench, Outward Taper (\$689 List each)	\$3,280 \$5,248	B

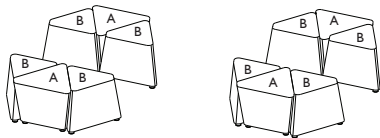

<u>Qty</u>	<u>Model #</u>	<u>Description</u>	<u>COM List</u>	<u>Key</u>
4	1340-J	20" Modular Bench, Inward Taper (\$689 List each)	\$2,756	A
8	1341-J	20" Modular Bench, Outward Taper (\$689 List each)	\$5,512 \$8,268	B

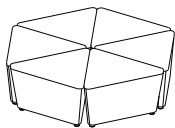

<u>Qty</u>	<u>Model #</u>	<u>Description</u>	<u>COM List</u>	<u>Key</u>
6	1348-J	28" Modular Bench, Inward Taper (\$846 List each)	\$5,076	n/a

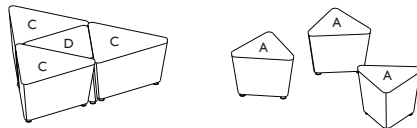

<u>Qty</u>	<u>Model #</u>	<u>Description</u>	<u>COM List</u>	<u>Key</u>
3	1340-J	20" Modular Bench, Inward Taper (\$689 List each)	\$2,067	A
3	1348-J	28" Modular Bench, Inward Taper (\$846 List each)	\$2,538	C
1	1349-J	28" Modular Bench, Outward Taper	\$846 \$5,451	D

PARTICLES JUNIOR | Designed by Chris Panichella

UPHOLSTERY COMBINATIONS:

- For upholstery combinations, refer to the pricing below.
- When combining two COM/COV/COL fabrics, or fabrics with the same grade, add \$85 List per unit.
- When combining three or more COM/COV/COL fabrics, or fabrics with the same grade, add \$115 List per unit.
- When combining different grades of fabric, price will be based on the highest grade specified.
- Two-tone upholstery examples and yardage requirements for the most common combinations are listed below. Additional combinations available; please contact client Services for yardage requirements and pricing.
- Note: Yardage amounts are based on fabric which is plain (i.e. non-directional) and a full 54" wide.
- Appropriate upholstery code must be included.



Code PJ1

Model [COM Requirement](#)

1340-J Seat Cushion Only = 1.25 yds.
Side Panels & Welt = 2 yds.



Code PJ2

Model [COM Requirement](#)

1341-J Seat Cushion Only = 1.25 yds.
Side Panels & Welt = 2 yds.



Code PJ3

Model [COM Requirement](#)

1348-J Seat Cushion Only = 1.25 yds.
Side Panels & Welt = 2 yds.



Code PJ4

Model [COM Requirement](#)

1349-J Seat Cushion Only = 1.25 yds.
Side Panels & Welt = 2 yds.



Code PJ5

Model [COM Requirement](#)

1340-J Seat Cushion & Welt = 2 yds.
Side Panels Only = 1.75 yds.



Code PJ6

Model [COM Requirement](#)

1341-J Seat Cushion & Welt = 2 yds.
Side Panels Only = 1.75 yds.



Code PJ7

Model [COM Requirement](#)

1348-J Seat Cushion & Welt = 2 yds.
Side Panels Only = 1.75 yds.



Code PJ8

Model [COM Requirement](#)

1349-J Seat Cushion & Welt = 2 yds.
Side Panels Only = 1.75 yds.

PARTICLES TABLES | Designed by Chris Panichella



SPECIFICATIONS:

- Occasional tables offered in round and rectangular top shapes.
- Triangular pull-up tables also offered in two heights: 19" and 25".
- Wood veneer, laminate and solid surface top options with an exposed wood edge.
- Three wood species available: beech, white oak and walnut.
- For standard wood and laminate options, please refer to standard finish card.
- For custom wood finishes, please contact client services and add one-time upcharge of \$450 List per color per order.
- For custom laminate options, add \$550 List per color per order. Pre-approval required, please contact client services.
- Solid surface available in white only.
- Metal base available in standard and premium finishes. See below for options.
- For custom metal finish colors, please contact client services for pricing.
- All dimensions are nominal.
- Refer to terms and conditions for general information regarding fabrics, finishes, warranty, freight, complete condition of sales and more.

STANDARD METAL BASE FINISH COLORS:

- #06 Charcoal Grey
- #90 Metallic Silver
- #91 Chrome
- #95 Satin Black

PREMIUM METAL BASE FINISH COLORS:



- #07 Gold Shimmer
- #08 Penny
- #09 Brown Sugar
- #83 Metallic Champagne
- #94 Cotton

All shipments for this series will be blanket-wrapped as standard. If cartoning is required, a 5% upcharge will be added to each product. Please contact client services for additional information.

PARTICLES OCCASIONAL TABLES | Designed by Chris Panichella

ORDERING REQUIREMENTS:

- Model number
- Top surface
- Top finish
- Base finish
- Options, as applicable

	MODEL	DIMENSIONS	VENEER TOP (-V)	LAMINATE TOP (-L)	SOLID SURFACE TOP (-SF)	WEIGHT
	Round Table					
	1380-1616-()	16" Dia. x 16" H	802	689	787	11 lbs.
	1380-1619-()	16" Dia. x 19" H	837	726	824	11 lbs.
	1380-1816-()	18" Dia. x 16" H	893	742	866	12 lbs.
	1380-1819-()	18" Dia. x 19" H	930	779	903	12 lbs.
	Rectangular Table					
	1380-482016-()	48" W x 20" D x 16" H	1,801	1,445	2,045	29 lbs.

OPTIONS

-PF02 Premium Metal Base Finish \$80



Note: Round solid surface tops may vary slightly in size from the dimensions listed above. Please contact client services if exact dimensions are required.

All shipments for this series will be blanket-wrapped as standard. If cartoning is required, a 5% upcharge will be added to each product. Please contact client services for additional information.

PARTICLES PULL-UP TABLES | Designed by Chris Panichella

ORDERING REQUIREMENTS:

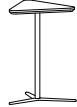
- Model number
- Top surface
- Top finish
- Base finish
- Options, as applicable

	MODEL	DESCRIPTION	veneer TOP (-V)	LAMINATE TOP (-L)	SOLID SURFACE TOP (-SF)	WEIGHT
	1390-1819-()	18" W x 19" H Pull-Up Table Overall: 18" W x 16" D x 19" H	826	721	941	8 lbs.
	1390-1825-()	18" W x 25" H Pull-Up Table Overall: 18" W x 16" D x 25" H	897	793	1,013	10 lbs.
	1390-2619-()	26" W x 19" H Pull-Up Table Overall: 26" W x 23" D x 19" H	1,065	892	1,236	12 lbs.
	1390-2625-()	26" W x 25" H Pull-Up Table Overall: 26" W x 23" D x 25" H	1,138	963	1,307	14 lbs.

OPTIONS

-PF02 Premium Metal Base Finish \$80

PIXIE STOOLS | Designed by Qdesign



SPECIFICATIONS:

- Two heights: 17" and 30".
- 17" models feature round seat.
- 30" models feature triangular seat.
- 1/2" diameter steel rod frame.
- Frame available in standard and premium finishes. Please refer to listing below.
- For custom finish colors, please contact client services for pricing.
- 350 lb. weight capacity.
- Optional clear glides for hard surface flooring.
- All dimensions are nominal.
- Refer to terms and conditions for general information regarding fabrics, finishes, warranty, freight, complete condition of sales and more.

STANDARD METAL FRAME FINISH COLORS:

- #06 Charcoal Grey
- #90 Metallic Silver
- #91 Chrome
- #95 Satin Black

PREMIUM METAL FRAME FINISH COLORS:

- #07 Gold Shimmer
- #08 Penny
- #09 Brown Sugar
- #83 Metallic Champagne
- #94 Cotton

All shipments for this series will be blanket-wrapped as standard. If cartoning is required, a 5% upcharge will be added to each product. Please contact client services for additional information.



PIXIE STOOLS | Designed by Qdesign



#90 Metallic Silver and
#91 Chrome Finishes Only

ORDERING REQUIREMENTS:

- Model number
- Frame finish
- Upholstery selection
- Options, as applicable

MODEL	PRODUCT SPECIFICATIONS	BASE FINISH		FABRIC GRADES								LEATHER	
		COM	A	1	2	3	4	COL 5	6	7	8	L1	L2
1010-17 	17" Height Stool 14.5" W x 13.75" D x 17" H Seat: 12" Diameter Seat Ht: 17" COM: .5 yd. COL: 10 sq. ft. 8 lbs.	459	479	493	501	515	530	543	557	570	585	650	697
1020-30 	30" Bar-Height Stool 18.5" W x 15.5" D x 31" H Seat: 14" W x 13.25" D Seat Ht: 31" COM: .5 yd. COL: 10 sq. ft. 12 lbs.	525	545	559	567	581	596	609	623	636	651	716	763

OPTIONS

- PF02 Premium Metal Frame Finish \$80
- CG03 Clear Glides (set of 6) \$15

PLAYGROUND | Designed by Chris Panichella



PRODUCT FEATURES:

- Metal frame available in standard and premium finishes. See following pages for options.
- For custom metal finish colors, please contact client services for pricing.
- Optional power units available for placement under select seating units.
- All dimensions are nominal.
- Refer to terms and conditions for general information regarding fabrics, finishes, warranty, freight, complete condition of sales and more.

BENCHES:

- Multiple bench sizes and shapes offered with or without backrest, available individually or in modular combinations.
- Optional ganging connector offered for modular configurations. Please specify "GC07" with quantity and add \$50 List per set.
- Three ottoman sizes available: 22", 30" and 36".
- Single seat benches and ottomans feature 350 lb. weight capacity.
- Two-seat benches feature 600 lb. weight capacity.
- Please include layout drawings or sketch with each modular order.

LOUNGE SEATING:

- Lounge, love seat and sofa models.
- Lounge chair features 350 lb. weight capacity, love seat features 600 lb. weight capacity and sofa features 900 lb. weight capacity.

PLAYGROUND | Designed by Chris Panichella

ROTATING TABLET:

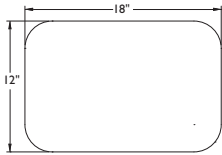

- Available on select modular bench units and ottomans.
- Tablet size is 18" W x 12" D x .75" thick and features 360-degree turning radius.
- Two tablet surface options: wood veneer and laminate.
- Three wood species available: beech, white oak and walnut.
- For standard wood and laminate options, please refer to standard finish card.
- For custom wood finishes, please contact client services and add one-time upcharge of \$450 List per color per order.
- For custom laminate options, add \$550 List per color per order. Pre-approval required, please contact client services.
- Tablet with veneer or standard wood grain laminate top, edge finish will match top finish color, unless specified otherwise.
- For solid color laminates, edge will be natural exposed plywood with a clear coat finish as standard, unless specified otherwise.
- Tablet mounting post will match frame/leg finish unless specified otherwise.
- Please note that tablet is not available on modular corner units due to space limitations.

STATIONARY TABLE-ETTE:

- Available on select modular bench units as well as ottomans.
- Table-ette size is 12" dia. x .75" thick.
- Two table-ette surface options: wood veneer and laminate.
- Three wood species available: beech, white oak and walnut.
- For standard wood and laminate options, please refer to standard finish card.
- For custom wood finishes, please contact client services and add one-time upcharge of \$450 List per color per order.
- For custom laminate options, add \$550 List per color per order. Pre-approval required, please contact client services.
- Tablet with veneer or standard wood grain laminate top, edge finish will match top finish color unless specified otherwise.
- For solid color laminates, edge will be natural exposed plywood with a clear coat finish as standard unless specified otherwise.
- Table-ette mounting post will match frame/leg finish unless specified otherwise.
- Please note that center placement for is only available on 56" straight bench and requires the addition of a center leg.
- Table-ette is not available on modular corner units due to space limitations.

STANDARD METAL FRAME FINISH COLORS:

- #06 Charcoal Grey
- #90 Metallic Silver
- #91 Chrome
- #95 Satin Black

PREMIUM METAL FRAME FINISH COLORS:

- #07 Gold Shimmer
- #08 Penny
- #09 Brown Sugar
- #83 Metallic Champagne
- #94 Cotton

PLAYGROUND | Designed by Chris Panichella

MINI-TAP POWER UNITS:

- Available on all modular benches and lounge models (not available on ottoman units).
- Dimensions: 3" W x 3" D x 1.75" H
- Black and white color options.
- 72" electrical cord (no hardware option or daisy chain feature available for this series).
- Placement is located under seat and may be affixed to side or front of seating unit. For side placement, unit will be centered. For front placement, please specify left, center or right, as seated.
- UL listed.

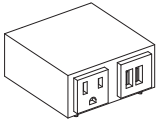

Mini-Tap 1 (MT1)

- One outlet and two USB charging ports.

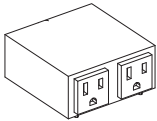

Mini-Tap 2 (MT2)

- Two outlets.

FABRIC APPLICATION:

- Fabric is cut "up the roll" as a standard cutting procedure (see example below). If another direction is required (i.e. "railroaded"), please specify and contact client services for yardage requirements.
- Note: Upholstery direction must be specified on corner units when patterned fabrics are selected. In the absence of specific instructions, Encore reserves the right to upholster at our discretion.

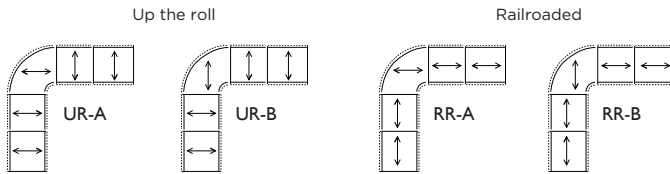

Modular Arrangements:

- Optional ganging bracket available for modular bench units. Please specify "-GC07" with quantity and add \$50 List per set. One set contains two brackets for connecting two units together.
- Field assembly required.



- Note: Layout drawings or sketch is required with each modular order.

All shipments for this series will be blanket-wrapped as standard. If cartoning is required, a 5% upcharge will be added to each product. Please contact client services for additional information.

PLAYGROUND MODULAR | Designed by Chris Panichella

ORDERING REQUIREMENTS:

- Model number
- Frame finish
- Upholstery selection
- Options, as applicable

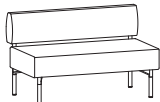
MODEL	PRODUCT SPECIFICATIONS	FABRIC GRADES										LEATHER	
		COM	A	1	2	3	4	COL 5	6	7	8	L1	L2
7224-BR 	Bench with Backrest 24" Straight 24" W x 26.75" D x 29.5 H" Seat: 24" W x 23" D Seat Ht: 17.5" COM: 1.75 yds. COL: 35 sq. ft. 42 lbs.	1,229	1,299	1,348	1,376	1,425	1,476	1,523	1,572	1,618	1,669	1,896	2,062
7248-BR 	Bench with Backrest 48" Straight 48" W x 26.75" D x 29.5 H" Seat: 48" W x 23" D Seat Ht: 17.5" COM: 3.25 yds. COL: 65 sq. ft. 67 lbs.	1,798	1,928	2,019	2,071	2,162	2,257	2,344	2,435	2,520	2,614	3,037	3,345

OPTIONS



-PF02	Premium Metal Frame Finish	\$80	-TAR02-W	Wood Rotating Tablet, Right (as seated)	\$468
-MB01	Moisture Barrier (24" bench)	\$52	-TAL02-W	Wood Rotating Tablet, Left (as seated)	\$468
-MB02	Moisture Barrier (48" bench)	\$73	-TAR02-L	Laminate Rotating Tablet, Right (as seated)	\$468
-NS04	Non-Skid Glides	\$42	-TAL02-L	Laminate Rotating Tablet, Left (as seated)	\$468
-GC07	Ganging Connector	\$50	-STR01-W	Wood Stationary Table-ette, Right (as seated)	\$433
-MT1-B	Mini-Tap Power Unit (1 power, 2 USB), Black	\$494	-STL01-W	Wood Stationary Table-ette, Left (as seated)	\$433
-MT1-W	Mini-Tap Power Unit (1 power, 2 USB), White	\$494	-STR01-L	Laminate Stationary Table-ette, Right (as seated)	\$433
-MT2-B	Mini-Tap Power Unit (2 power), Black	\$442	-STL01-L	Laminate Stationary Table-ette, Left (as seated)	\$433
-MT2-W	Mini-Tap Power Unit (2 power), White	\$442			

All shipments for this series will be blanket-wrapped as standard. If cartoning is required, a 5% upcharge will be added to each product. Please contact client services for additional information.

PLAYGROUND MODULAR | Designed by Chris Panichella

ORDERING REQUIREMENTS:

- Model number
- Frame finish
- Upholstery selection
- Options, as applicable

MODEL	PRODUCT SPECIFICATIONS	FABRIC GRADES								LEATHER			
		COM	A	1	2	3	4	COL 5	6	7	8	L1	L2
7223-BR-L 	Bench with Backrest Left End Corner Unit 26.75" W x 26.75" D x 29.5" H Seat: 23" W x 23" D Seat Ht: 17.5" COM: 2.25 yds. COL: 45 sq. ft. 45 lbs.	1,568	1,658	1,721	1,757	1,820	1,886	1,946	2,009	2,068	2,133	2,426	2,639
7223-BR-C 	Bench with Backrest Corner Unit 26.75" W x 26.75" D x 29.5" H Seat: 23" W x 23" D Seat Ht: 17.5" COM: 2.25 yds. COL: 45 sq. ft. 45 lbs.	1,568	1,658	1,721	1,757	1,820	1,886	1,946	2,009	2,068	2,133	2,426	2,639
7223-BR-R 	Bench with Backrest Right End Corner Unit 26.75" W x 26.75" D x 29.5" H Seat: 23" W x 23" D Seat Ht: 17.5" COM: 2.25 yds. COL: 45 sq. ft. 45 lbs.	1,568	1,658	1,721	1,757	1,820	1,886	1,946	2,009	2,068	2,133	2,426	2,639

OPTIONS

-PF02	Premium Metal Frame Finish	\$80
-MB01	Moisture Barrier (seat only)	\$52
-NS04	Non-Skid Glides	\$42
-GC07	Ganging Connector	\$50
-MT1-B	Mini-Tap Power Unit (1 power, 2 USB), Black	\$494
-MT1-W	Mini-Tap Power Unit (1 power, 2 USB), White	\$494
-MT2-B	Mini-Tap Power Unit (2 power), Black	\$442
-MT2-W	Mini-Tap Power Unit (2 power), White	\$442

All shipments for this series will be blanket-wrapped as standard. If cartoning is required, a 5% upcharge will be added to each product. Please contact client services for additional information.

PLAYGROUND MODULAR | Designed by Chris Panichella

ORDERING REQUIREMENTS:

- Model number
- Frame finish
- Upholstery selection
- Options, as applicable

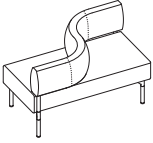
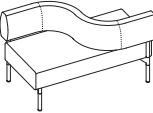
MODEL	PRODUCT SPECIFICATIONS	FABRIC GRADES										LEATHER	
		COM	A	1	2	3	4	COL 5	6	7	8	L1	L2
7248-LT 	Bench with Backrest Left Transition 48" W x 30.5" D x 29.5" H Seat: 48" W x 23" D Seat Ht: 17.5" COM: 3.5 yds. COL: 70 sq. ft. 73 lbs.	1,962	2,102	2,200	2,256	2,354	2,456	2,550	2,648	2,739	2,841	3,296	3,628
7248-RT 	Bench with Backrest Right Transition 48" W x 30.5" D x 29.5" H Seat: 48" W x 23" D Seat Ht: 17.5" COM: 3.5 yds. COL: 70 sq. ft. 73 lbs.	1,962	2,102	2,200	2,256	2,354	2,456	2,550	2,648	2,739	2,841	3,296	3,628

OPTIONS

-PF02	Premium Metal Frame Finish	\$80
-MB02	Moisture Barrier (seat only)	\$73
-NS04	Non-Skid Glides	\$42
-GC07	Ganging Connector	\$50
-MT1-B	Mini-Tap Power Unit (1 power, 2 USB), Black	\$494
-MT1-W	Mini-Tap Power Unit (1 power, 2 USB), White	\$494
-MT2-B	Mini-Tap Power Unit (2 power), Black	\$442
-MT2-W	Mini-Tap Power Unit (2 power), White	\$442

All shipments for this series will be blanket-wrapped as standard. If cartoning is required, a 5% upcharge will be added to each product. Please contact client services for additional information.

PLAYGROUND MODULAR | Designed by Chris Panichella

ORDERING REQUIREMENTS:

- Model number
- Frame finish
- Upholstery selection
- Options, as applicable

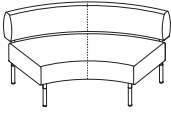
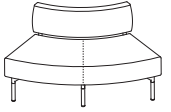
MODEL	PRODUCT SPECIFICATIONS	FABRIC GRADES								LEATHER			
		COM	A	1	2	3	4	COL 5	6	7	8	L1	L2
7260-BR	 <p>Bench with Backrest 60-Degree Inside Wedge 61.5" W x 31.25" D x 29.5" H" Seat: 57.5" W x 27.5" D Seat Ht: 17.5" COM: 4.25 yds. COL: 85 sq. ft. 72 lbs.</p>	2,200	2,370	2,489	2,557	2,676	2,800	2,914	3,033	3,144	3,267	3,820	4,223
7261-BR	 <p>Bench with Backrest 60-Degree Outside Wedge 57.75" W x 31" D x 29.5" H" Seat: 57.5" W x 27.5" D Seat Ht: 17.5" COM: 3.5 yds. COL: 70 sq. ft. 48 lbs.</p>	1,908	2,048	2,146	2,202	2,300	2,402	2,496	2,594	2,685	2,787	3,242	3,574

OPTIONS



-PF02	Premium Metal Frame Finish	\$80	-TAR02-W	Wood Rotating Tablet, Right (as seated)	\$468
-MB02	Moisture Barrier (seat only)	\$73	-TAL02-W	Wood Rotating Tablet, Left (as seated)	\$468
-NS04	Non-Skid Glides	\$42	-TAR02-L	Laminate Rotating Tablet, Right (as seated)	\$468
-GC07	Ganging Connector	\$50	-TAL02-L	Laminate Rotating Tablet, Left (as seated)	\$468
-MT1-B	Mini-Tap Power Unit (1 power, 2 USB), Black	\$494	-STR01-W	Wood Stationary Table-ette, Right (as seated)	\$433
-MT1-W	Mini-Tap Power Unit (1 power, 2 USB), White	\$494	-STL01-W	Wood Stationary Table-ette, Left (as seated)	\$433
-MT2-B	Mini-Tap Power Unit (2 power), Black	\$442	-STR01-L	Laminate Stationary Table-ette, Right (as seated)	\$433
-MT2-W	Mini-Tap Power Unit (2 power), White	\$442	-STL01-L	Laminate Stationary Table-ette, Left (as seated)	\$433

All shipments for this series will be blanket-wrapped as standard. If cartoning is required, a 5% upcharge will be added to each product. Please contact client services for additional information.

PLAYGROUND MODULAR | Designed by Chris Panichella

ORDERING REQUIREMENTS:

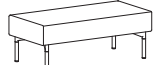
- Model number
- Leg finish
- Upholstery selection
- Options, as applicable

MODEL	PRODUCT SPECIFICATIONS	FABRIC GRADES										LEATHER	
		COM	A	1	2	3	4	COL 5	6	7	8	L1	L2
7224 	24" Straight Bench Overall: 24" W x 23" D x 17.5" H COM: 1.25 yds. COL: 25 sq. ft. 33 lbs.	853	903	938	958	993	1,030	1,063	1,098	1,131	1,167	1,330	1,448
7248 	48" Straight Bench Overall: 48" W x 23" D x 17.5" H COM: 1.75 yds. COL: 35 sq. ft. 56 lbs.	1,166	1,236	1,285	1,313	1,362	1,413	1,460	1,509	1,555	1,606	1,833	1,999
7256 	56" Straight Bench Overall: 56" W x 23" D x 17.5" H COM: 2.5 yds. COL: 40 sq. ft. 66 lbs.	1,322	1,422	1,492	1,532	1,602	1,675	1,742	1,812	1,877	1,950	2,275	2,512

OPTIONS



-PF02	Premium Metal Leg Finish	\$80	-TAC01-W	Wood Rotating Tablet, Center	\$468
-MB01	Moisture Barrier (24" bench)	\$52	-TAL02-W	Wood Rotating Tablet, Left (as seated)	\$468
-MBO2	Moisture Barrier (48" & 56" bench)	\$73	-TAR02-L	Laminate Rotating Tablet, Right (as seated)	\$468
-NS04	Non-Skid Glides	\$42	-TAC01-L	Laminate Rotating Tablet, Center	\$468
-GC07	Ganging Connector	\$50	-TAL02-L	Laminate Rotating Tablet, Left (as seated)	\$468
-MT1-B	Mini-Tap Power Unit (1 power, 2 USB), Black	\$494	-STR01-W	Wood Stationary Table-ette, Right (as seated)	\$433
-MT1-W	Mini-Tap Power Unit (1 power, 2 USB), White	\$494	-STC02-W	Wood Stationary Table-ette, Center	\$433
-MT2-B	Mini-Tap Power Unit (2 power), Black	\$442	-STL01-W	Wood Stationary Table-ette, Left (as seated)	\$433
-MT2-W	Mini-Tap Power Unit (2 power), White	\$442	-STR01-L	Laminate Stationary Table-ette, Right (as seated)	\$433
-TAR02-W	Wood Rotating Tablet, Right (as seated)	\$468	-STC02-L	Laminate Stationary Table-ette, Center	\$433
			-STL01-L	Laminate Stationary Table-ette, Left (as seated)	\$433

All shipments for this series will be blanket-wrapped as standard. If cartoning is required, a 5% upcharge will be added to each product. Please contact client services for additional information.

PLAYGROUND MODULAR | Designed by Chris Panichella

ORDERING REQUIREMENTS:

- Model number
- Leg finish
- Upholstery selection
- Options, as applicable

MODEL	PRODUCT SPECIFICATIONS	FABRIC GRADES								LEATHER			
		COM	A	1	2	3	4	COL 5	6	7	8	L1	L2
7223-L 	Left End Corner Unit Overall: 23" W x 23" D x 17.5" H COM: 1.25 yds. COL: 25 sq. ft. 36 lbs.	901	951	986	1,006	1,041	1,078	1,111	1,146	1,179	1,215	1,378	1,496
7223-C 	Corner Unit Overall: 23" W x 23" D x 17.5" H COM: 1.25 yds. COL: 25 sq. ft. 36 lbs.	901	951	986	1,006	1,041	1,078	1,111	1,146	1,179	1,215	1,378	1,496
7223-R 	Right End Corner Unit Overall: 23" W x 23" D x 17.5" H COM: 1.25 yds. COL: 25 sq. ft. 36 lbs.	901	951	986	1,006	1,041	1,078	1,111	1,146	1,179	1,215	1,378	1,496

OPTIONS

-PF02	Premium Metal Leg Finish	\$80
-MB01	Moisture Barrier	\$52
-NS04	Non-Skid Glides	\$42
-GC07	Ganging Connector	\$50
-MT1-B	Mini-Tap Power Unit (1 power, 2 USB), Black	\$494
-MT1-W	Mini-Tap Power Unit (1 power, 2 USB), White	\$494
-MT2-B	Mini-Tap Power Unit (2 power), Black	\$442
-MT2-W	Mini-Tap Power Unit (2 power), White	\$442

All shipments for this series will be blanket-wrapped as standard. If cartoning is required, a 5% upcharge will be added to each product. Please contact client services for additional information.

PLAYGROUND MODULAR | Designed by Chris Panichella

ORDERING REQUIREMENTS:

- Model number
- Leg finish
- Upholstery selection
- Options, as applicable

MODEL	PRODUCT SPECIFICATIONS	FABRIC GRADES										LEATHER	
		COM	A	1	2	3	4	COL 5	6	7	8	L1	L2
7260	60-Degree Inside Wedge Bench Overall: 57.75" W x 27.5" D x 17.5" H COM: 2.25 yds. COL: 45 sq. ft. 48 lbs.	1,299	1,389	1,452	1,488	1,551	1,617	1,677	1,740	1,799	1,864	2,157	2,370
7261	60-Degree Outside Wedge Bench Overall: 57.75" W x 27.5" D x 17.5" H COM: 2.25 yds. COL: 45 sq. ft. 48 lbs.	1,299	1,389	1,452	1,488	1,551	1,617	1,677	1,740	1,799	1,864	2,157	2,370

OPTIONS



-PF02	Premium Metal Leg Finish	\$80	-TAR02-W	Wood Rotating Tablet, Right (as seated)	\$468
-MB02	Moisture Barrier	\$73	-TAL02-W	Wood Rotating Tablet, Left (as seated)	\$468
-NS04	Non-Skid Glides	\$42	-TAR02-L	Laminate Rotating Tablet, Right (as seated)	\$468
-GC07	Ganging Connector	\$50	-TAL02-L	Laminate Rotating Tablet, Left (as seated)	\$468
-MT1-B	Mini-Tap Power Unit (1 power, 2 USB), Black	\$494	-STR01-W	Wood Stationary Table-ette, Right (as seated)	\$433
-MT1-W	Mini-Tap Power Unit (1 power, 2 USB), White	\$494	-STL01-W	Wood Stationary Table-ette, Left (as seated)	\$433
-MT2-B	Mini-Tap Power Unit (2 power), Black	\$442	-STR01-L	Laminate Stationary Table-ette, Right (as seated)	\$433
-MT2-W	Mini-Tap Power Unit (2 power), White	\$442	-STL01-L	Laminate Stationary Table-ette, Left (as seated)	\$433

All shipments for this series will be blanket-wrapped as standard. If cartoning is required, a 5% upcharge will be added to each product. Please contact client services for additional information.

PLAYGROUND MODULAR | Designed by Chris Panichella

ORDERING REQUIREMENTS:

- Model number
- Leg finish
- Upholstery selection
- Options, as applicable

MODEL	PRODUCT SPECIFICATIONS	FABRIC GRADES										LEATHER	
		COM	A	1	2	3	4	COL 5	6	7	8	L1	L2
7222 	22" Round Ottoman Overall: 21.75" Dia. x 17.5" H COM: 1.5 yds. COL: 30 sq. ft. 25 lbs.	931	991	1,033	1,057	1,099	1,143	1,183	1,225	1,264	1,308	1,503	1,645
7230 	30" Round Ottoman Overall: 30" Dia. x 17.5" H COM: 1.5 yds. COL: 30 sq. ft. 35 lbs.	1,095	1,155	1,197	1,221	1,263	1,307	1,347	1,389	1,428	1,472	1,667	1,809
7236 	36" Round Ottoman Overall: 36" Dia. x 17.5" H COM: 2.25 yds. COL: 45 sq. ft. 48 lbs.	1,433	1,523	1,586	1,622	1,685	1,751	1,811	1,874	1,933	1,998	2,291	2,504

OPTIONS

-PF02	Premium Metal Leg Finish	\$80
-MB02	Moisture Barrier	\$73
-NS04	Non-Skid Glides	\$42
-STX01-W	Wood Stationary Table-ette	\$416
-STX01-L	Laminate Stationary Table-ette	\$416

All shipments will be blanket-wrapped as standard. If cartoning is required, a 5% upcharge will be added to each product for this series. Please contact client Services for additional information.

PLAYGROUND LOUNGE | Designed by Chris Panichella

ORDERING REQUIREMENTS:

- Model number
- Leg finish
- Upholstery selection
- Options, as applicable

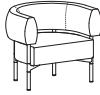
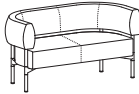
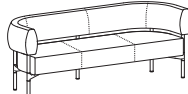
MODEL	PRODUCT SPECIFICATIONS	FABRIC GRADES										LEATHER	
		COM	A	1	2	3	4	COL 5	6	7	8	L1	L2
7201 	Lounge Chair 36" W x 27" D x 29.5" H Seat: 28.5" W x 23" D Seat Ht: 17.5" COM: 3 yds. COL: 60 sq. ft. 48 lbs.	1,707	1,827	1,911	1,959	2,043	2,130	2,211	2,295	2,373	2,460	2,850	3,135
7202 	Love Seat 58.75" W x 27" D x 29.5" H Seat: 50.5" W x 23" D Seat Ht: 17.5" COM: 3.75 yds. COL: 75 sq. ft. 83 lbs.	2,364	2,514	2,619	2,679	2,784	2,893	2,994	3,099	3,197	3,306	3,793	4,149
7203 	Sofa 82.5" W x 27" D x 29.5" H Seat: 74.75" W x 23" D Seat Ht: 17.5" COM: 5 yds. COL: 100 sq. ft. 108 lbs. 108 lbs.	3,064	3,264	3,404	3,484	3,624	3,769	3,904	4,044	4,174	4,319	4,969	5,444

OPTIONS

-PF02	Premium Metal Frame Finish	\$80
-MB02	Moisture Barrier (lounge and love seat, seat only)	\$73
-MB03	Moisture Barrier (sofa, seat only)	\$94
-NS04	Non-Skid Glides	\$42
-MT1-B	Mini-Tap Power Unit (1 power, 2 USB), Black	\$494
-MT1-W	Mini-Tap Power Unit (1 power, 2 USB), White	\$494
-MT2-B	Mini-Tap Power Unit (2 power), Black	\$442
-MT2-W	Mini-Tap Power Unit (2 power), White	\$442

PLAYGROUND MODULAR - CONFIGURATION & ORDERING EXAMPLES

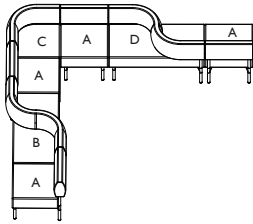

<u>Qty.</u>	<u>Model #</u>	<u>Description</u>	<u>COM List</u>	<u>Key</u>
4	7224-BR	Bench with Backrest, 24" Straight (\$1,229 List each)	\$4,916	A
1	7248-LT	Bench with Backrest, Left Transition	\$1,962	B
1	7223-BR-C	Bench with Backrest, Corner Unit	\$1,568	C
1	7248-RT	Bench with Backrest, Right Transition	\$1,962	D
			\$10,408	

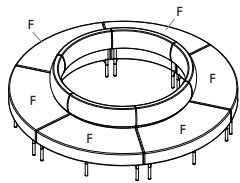

<u>Qty.</u>	<u>Model #</u>	<u>Description</u>	<u>COM List</u>	<u>Key</u>
6	7261-BR	Bench with Backrest, 60-Degree Outside Wedge (\$1,908 List each)	\$11,448	F

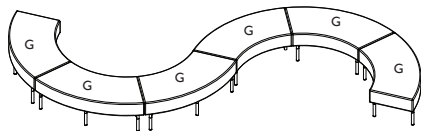

<u>Qty.</u>	<u>Model #</u>	<u>Description</u>	<u>COM List</u>	<u>Key</u>
6	7260	60-Degree Inside Wedge Bench (\$1,299 List each)	\$7,794	G

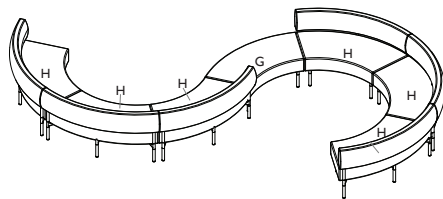

<u>Qty.</u>	<u>Model #</u>	<u>Description</u>	<u>COM List</u>	<u>Key</u>
6	7260-BR	Bench with Backrest, 60-Degree Inside Wedge (\$2,200 List each)	\$13,200	H
1	7260	60-Degree Inside Wedge Bench	\$1,299	G
			\$14,499	

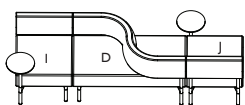

<u>Qty.</u>	<u>Model #</u>	<u>Description</u>	<u>COM List</u>	<u>Key</u>
1	7224-BR-STR01-W	Bench with Backrest, 24" Straight, Stationary Table-ette, Wood Top	\$1,662	I
1	7248-RT	Bench with Backrest, Right Transition	\$1,962	D
1	7224-BR-STL01-W	Bench with Backrest, 24" Straight, Stationary Table-ette, Wood Top	\$1,662	J
			\$5,286	

PLAYGROUND MODULAR & LOUNGE | Designed by Chris Panichella

UPHOLSTERY COMBINATIONS:

- For upholstery combinations, refer to the pricing below.
- When combining two COM/COV/COL fabrics, or fabrics with the same grade, add \$85 List per unit.
- When combining three or more COM/COV/COL fabrics, or fabrics with the same grade, add \$115 List per unit.
- When combining different grades of fabric, price will be based on the highest grade specified.
- Two-tone upholstery examples and yardage requirements for the most common combinations are listed below. Additional combinations available; please contact client Services for yardage requirements and pricing.
- Note: Yardage amounts are based on fabric which is plain (i.e. non-directional) and a full 54" wide.
- Appropriate upholstery code must be included.

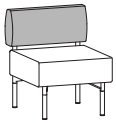

Code PL1
Model COM Requirement
7224-BR Backrest Only = 1 yd.
Balance of Bench = 1.75 yds.

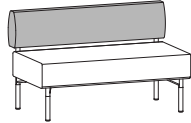

Code PL2
Model COM Requirement
7248-BR Backrest Only = 2 yds.
Balance of Bench = 2 yds.

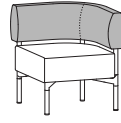

Code PL3
Model COM Requirement
7223-BR-C Backrest Only = 1.25 yds.
7223-BR-L Balance of Bench = 1.25 yds.
7223-BR-R

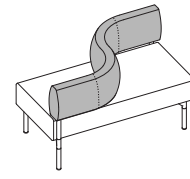

Code PL4
Model COM Requirement
7248-LT Backrest Only = 2 yds.
7248-RT Balance of Bench = 2 yds.

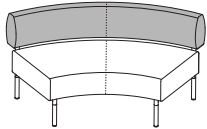

Code PL5
Model COM Requirement
7260-BR Backrest Only = 2 yds.
Balance of Bench = 2.25 yds.

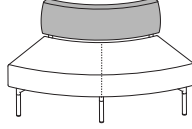

Code PL6
Model COM Requirement
7261-BR Backrest Only = 1.25 yds.
Balance of Bench = 2.25 yds.

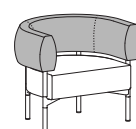

Code PL7
Model COM Requirement
7201 Backrest Only = 2 yds.
Balance of Lounge = 1 yd.

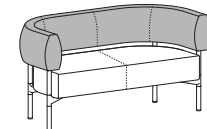

Code PL8
Model COM Requirement
7202 Backrest Only = 3 yds.
Balance of Love Seat = 2.25 yds.

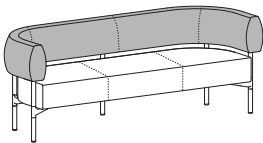

Code PL9
Model COM Requirement
7203 Backrest Only = 3 yds.
Balance of Sofa = 2.75 yds.

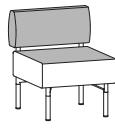

Code PL10
Model COM Requirement
7224-BR Backrest & Top of Seat = 2.5 yds.
Balance of Bench = .75 yd.

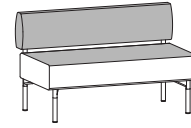

Code PL11
Model COM Requirement
7248-BR Backrest & Top of Seat = 3.5 yds.
Balance of Bench = .75 yd.

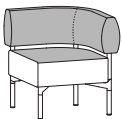

Code PL12
Model COM Requirement
7223-BR-C Backrest & Top of Seat = 1.75 yds.
7223-BR-L Balance of Bench = .75 yd.
7223-BR-R

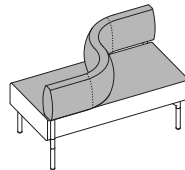

Code PL13
Model COM Requirement
7248-LT Backrest & Top of Seat = 3.5 yds.
7248-RT Balance of Bench = .75 yd.

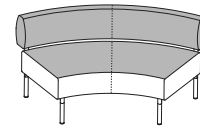

Code PL14
Model COM Requirement
7260-BR Backrest & Top of Seat = 3 yds.
Balance of Bench = 1.75 yds.

PLAYGROUND MODULAR & LOUNGE | Designed by Chris Panichella

UPHOLSTERY COMBINATIONS:

- For upholstery combinations, refer to the pricing below.
- When combining two COM/COV/COL fabrics, or fabrics with the same grade, add \$85 List per unit.
- When combining three or more COM/COV/COL fabrics, or fabrics with the same grade, add \$115 List per unit.
- When combining different grades of fabric, price will be based on the highest grade specified.
- Two-tone upholstery examples and yardage requirements for the most common combinations are listed below. Additional combinations available; please contact client Services for yardage requirements and pricing.
- Note: Yardage amounts are based on fabric which is plain (i.e. non-directional) and a full 54" wide.
- Appropriate upholstery code must be included.

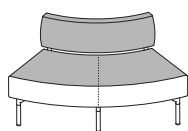

Code PL15
Model COM Requirement
 7261-BR Backrest & Top of Seat = 2.5 yds.
 Balance of Bench = 1.5 yds.

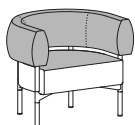

Code PL16
Model COM Requirement
 7201 Backrest & Top of Seat = 3 yds.
 Balance of Lounge = 1 yd.

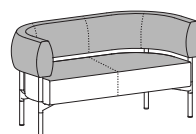

Code PL17
Model COM Requirement
 7202 Backrest & Top of Seat = 3.25 yds.
 Balance of Love Seat = 1.25 yds.

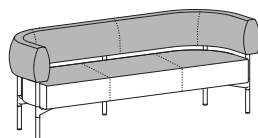

Code PL18
Model COM Requirement
 7203 Backrest & Top of Seat = 5 yds.
 Balance of Sofa = 1.25 yds.

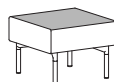

Code PL19
Model COM Requirement
 7224 Top of Seat = 1.5 yds.
 Balance of Bench = .75 yd.

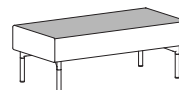

Code PL20
Model COM Requirement
 7248 Top of Seat = 1.5 yds.
 Balance of Bench = .75 yd.

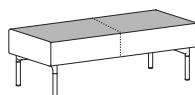

Code PL21
Model COM Requirement
 7256 Top of Seat = 2 yds.
 Balance of Bench = .75 yd.

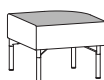

Code PL22
Model COM Requirement
 7223-C Top of Seat = 1.5 yds.
 7223-L Balance of Bench = .75 yd.
 7223-R

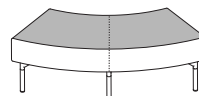

Code PL23
Model COM Requirement
 7260 Top of Seat = 1.75 yds.
 7261 Balance of Bench = 1.75 yds.



Code PL24
Model COM Requirement
 7222 Top of Seat = .75 yd.
 Balance of Bench = .75 yd.



Code PL25
Model COM Requirement
 7230 Top of Seat = 1 yd.
 Balance of Bench = 1 yd.

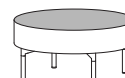

Code PL26
Model COM Requirement
 7236 Top of Seat = 1 yd.
 Balance of Bench = 1.25 yds.

PLAYGROUND OCCASIONAL TABLES | Designed by Chris Panichella



SPECIFICATIONS:

- Round, square and rectangular top shapes.
- Wood veneer and laminate top surface options.
- Three wood species available: beech, white oak and walnut.
- For standard wood and laminate options, please refer to standard finish card.
- For custom wood finishes, please contact client services and add one-time upcharge of \$450 List per color per order.
- For custom laminate options, add \$550 List per color per order. Pre-approval required, please contact client services.
- Table with veneer or standard wood grain laminate top, edge finish will match top finish color, unless specified otherwise.
- For solid color laminates, edge will be exposed plywood with a clear coat finish as standard, unless specified otherwise.
- Metal legs offered in standard and premium finishes. Please refer to listing below.
- For custom finish colors, please contact client services for pricing.
- Optional 16" diameter fixed second-tier table offered in wood veneer or laminate.
- Second-tier table finish will match table-top finish unless specified otherwise.
- **Please note that second-tier table is only available on round and oval table sizes 29" diameter/width and larger. It is not available on square tables, rectangular tables or round table #7270-2116.**
- All dimensions are nominal.
- Refer to terms and conditions for general information regarding fabrics, finishes, warranty, freight, complete condition of sales and more.

STANDARD METAL LEG FINISH COLORS:

- #06 Charcoal Grey
- #90 Metallic Silver
- #91 Chrome
- #95 Satin Black

PREMIUM METAL LEG FINISH COLORS:



- #07 Gold Shimmer
- #08 Penny
- #09 Brown Sugar
- #83 Metallic Champagne
- #94 Cotton

All shipments for this series will be blanket-wrapped as standard. If cartoning is required, a 5% upcharge will be added to each product. Please contact client services for additional information.

PLAYGROUND OCCASIONAL TABLES | Designed by Chris Panichella

ORDERING REQUIREMENTS:

- Model number
- Top surface
- Top finish
- Leg finish
- Options, as applicable

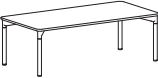
	MODEL	DIMENSIONS	WOOD (-V) OR LAMINATE (-L) TOP	WEIGHT
	Round Table			
	7270-2116-()	21" Dia. x 16" H	764	15 lbs.
	7270-2916-()	29" Dia. x 16" H	1,132	21 lbs.
	7270-3616-()	36" Dia. x 16" H	1,424	28 lbs.
	7270-4216-()	42" Dia. x 16" H	1,484	33 lbs.
	Oval Table			
	7275-362416-()	36" W x 24" D x 16" H	1,131	25 lbs.
	7275-462416-()	46" W x 24" D x 16" H	1,304	31 lbs.
	Square Table			
	7280-222216-()	22" W x 22" D x 16" H	765	16 lbs.
	7280-303016-()	30" W x 30" D x 16" H	1,132	22 lbs.
	7280-363616-()	36" W x 36" D x 16" H	1,424	28 lbs.
	7280-424216-()	42" W x 42" D x 16" H	1,483	33 lbs.
	Rectangular Table			
	7280-482416-()	48" W x 24" D x 16" H	1,306	34 lbs.

OPTIONS

-PF02	Premium Metal Leg Finish	\$80
-NS04	Non-Skid Glides	\$42
-STX02-W	Wood Second-Tier Table	\$478
-STX02-L	Laminate Second-Tier Table	\$478

All shipments for this series will be blanket-wrapped as standard. If cartoning is required, a 5% upcharge will be added to each product. Please contact client services for additional information.

POPOVER POUFS | Designed by Chris & Jon Panichella



SPECIFICATIONS:

- Square poufs available in two sizes: 20" and 24".
- Leather pull/strap offered in four standard colors. Please refer to listing below.
- Pull/strap also available in COL (Customer's Own Leather).
- Each unit comes standard with glides.
- Optional felt glides for hard surface flooring.
- 300 lb. weight capacity.
- All dimensions are nominal.
- Refer to terms and conditions for general information regarding fabrics, finishes, warranty, freight, complete condition of sales and more.

STANDARD LEATHER PULL/STRAP COLORS:

- Black
- Bright White
- Saddle
- Flint

All shipments for this series will be blanket-wrapped as standard. If cartoning is required, a 5% upcharge will be added to each product. Please contact client services for additional information.

POPOVER POUFS | Designed by Chris & Jon Panichella



ORDERING REQUIREMENTS:

- Model number
- Pull/strap color
- Upholstery selection
- Options, as applicable

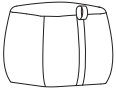
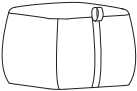
MODEL	PRODUCT SPECIFICATIONS	FABRIC GRADES										LEATHER	
		COM	A	1	2	3	4	COL 5	6	7	8	L1	L2
3820 	20" Square Pouf 20" W x 20" D x 17.5" H COM: 2 yds. COL: 40 sq. ft. 22 lbs.	755	835	891	923	979	1,037	1,091	1,147	1,199	1,257	1,517	1,707
3824 	24" Square Pouf 24" W x 24" D x 17.5" H COM: 2 yds. COL: 40 sq. ft. 28 lbs.	785	865	921	953	1,009	1,067	1,121	1,177	1,229	1,287	1,547	1,737

OPTIONS

- P03 COL Pull/Strap \$100
(requires 3" x 30" per unit)
- FG04 Felt Glides \$40

POPOVER POUFS | Designed by Chris & Jon Panichella

UPHOLSTERY COMBINATIONS:

- For upholstery combinations, refer to the pricing below.
- When combining two COM/COV/COL fabrics, or fabrics with the same grade, add \$85 List per unit.
- When combining three or more COM/COV/COL fabrics, or fabrics with the same grade, add \$115 List per unit.
- When combining different grades of fabric, price will be based on the highest grade specified.
- Two-tone upholstery examples and yardage requirements for the most common combinations are listed below. Additional combinations available; please contact client Services for yardage requirements and pricing.
- Note: Yardage amounts are based on fabric which is plain (i.e. non-directional) and a full 54" wide.
- Appropriate upholstery code must be included.

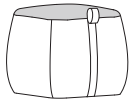

Code PV1

<u>Model</u>	<u>COM Requirement</u>
All Models	Top of Seat = .75 yd. Side Panels = 1.25 yds.

All shipments for this series will be cartoned as standard. If blanket-wrapped shipping is required, please contact client services for additional information.

PROPEL | Designed by Baldanzi & Novelli



SPECIFICATIONS:

- Mesh and upholstered back models.
- Mesh suspension available in three colors. Please refer to listing below.
- Back shell is black as standard.
- White back shell also available. Please specify (-W02) after model number and add \$78 List.
- Armless, adjustable t-arm and cantilever arm models.
- Adjustable t-arm is available in black or white with black arm cap.
- 3" adjustable t-arm height travel.
- Cantilever arm available in black or white as standard.
- Unless specified otherwise, arm color will match back shell color.
- Polished aluminum cantilever arm also available. Please specify (-PCA01) after model number and add \$125 List.
- Fixed back height.
- Optional headrest also available.
- Adjustable lumbar support standard.
- Memory foam standard on seat.
- Two base options: black nylon and polished aluminum.
- 300 lb. weight capacity.
- All dimensions are nominal.
- Synchro-tilt and weight-activated mechanism options. Refer to pages 13-15 for mechanism guide.
- Refer to terms and conditions for general information regarding fabrics, finishes, warranty, freight, complete condition of sales and more.

MESH SUSPENSION COLORS:

- #107 Sterling
- #109 Night
- #126 Wheat



All shipments for this series will be cartoned as standard. If blanket-wrapped shipping is required, please contact client services for additional information.

PROPEL | Designed by Baldanzi & Novelli

Weight-Activated Mechanism

ORDERING REQUIREMENTS:

- Model number
- Mesh suspension color
- Back shell color
- Arm color
- Base finish
- Seat upholstery selection
- Options, as applicable

MODEL	PRODUCT SPECIFICATIONS	BASE FINISH	FABRIC GRADES								LEATHER			
			COM	A	1	2	3	4	COL 5	6	7	8	L1	L2
4421-K 	Mesh-Back, Armless 20" W x 23" D x 39" - 44" H Seat: 19" W x 18.5" D Seat Ht: 17" - 22" Back: 19" W x 24" H COM: .75 yd. COL: 15 sq. ft. 36 lbs.	Black Nylon	858	888	909	921	942	964	984	1,005	1,025	1,047	1,144	1,215
		Polished Aluminum	937	967	988	1,000	1,021	1,043	1,063	1,084	1,104	1,126	1,223	1,294
4423-K 	Mesh-Back, Adjustable T-Arms 25" W x 23" D x 39" - 44" H Seat: 19" W x 18.5" D Seat Ht: 17" - 22" Back: 19" W x 24" H COM: .75 yd. COL: 15 sq. ft. 43 lbs.	Black Nylon	902	932	953	965	986	1,008	1,028	1,049	1,069	1,091	1,188	1,259
		Polished Aluminum	981	1,011	1,032	1,044	1,065	1,087	1,107	1,128	1,148	1,170	1,267	1,338
4424-K 	Mesh-Back, Cantilever Arms 23.5" W x 23" D x 39" - 44" H Seat: 19" W x 18.5" D Seat Ht: 17" - 22" Back: 19" W x 24" H COM: .75 yd. COL: 15 sq. ft. 40 lbs.	Black Nylon	902	932	953	965	986	1,008	1,028	1,049	1,069	1,091	1,188	1,259
		Polished Aluminum	981	1,011	1,032	1,044	1,065	1,087	1,107	1,128	1,148	1,170	1,267	1,338

OPTIONS

-HR01	Headrest	\$103
-W02	White Back Shell	\$78
-PCA01	Polished Cantilever Arms	\$125
-SS01	Seat Slider	\$76
-STC02	Soft Tread Casters	\$26
-STLC02	Soft Tread Self-Locking Casters	\$52
-GD04	Glides	\$26
-J01	Jury Base (black only)	\$150



All shipments for this series will be cartoned as standard. If blanket-wrapped shipping is required, please contact client services for additional information.

PROPEL | Designed by Baldanzi & Novelli

Synchro-Tilt Mechanism

ORDERING REQUIREMENTS:

- Model number
- Mesh suspension color
- Back shell color
- Arm color
- Base finish
- Seat upholstery selection
- Options, as applicable

MODEL	PRODUCT SPECIFICATIONS	BASE FINISH	FABRIC GRADES										LEATHER	
			COM	A	1	2	3	4	COL 5	6	7	8	L1	L2
4491-K 	Mesh-Back, Armless 20" W x 23" D x 38.5" - 43.5" H Seat: 19" W x 18.5" D Seat Ht: 16.5" - 21.5" Back: 19" W x 24" H COM: .75 yd. COL: 15 sq. ft. 33 lbs.	Black Nylon	814	844	865	877	898	920	940	961	981	1,003	1,100	1,171
		Polished Aluminum	893	923	944	956	977	999	1,019	1,040	1,060	1,082	1,179	1,250
4493-K 	Mesh-Back, Adjustable T-Arms 25" W x 23" D x 38.5" - 43.5" H Seat: 19" W x 18.5" D Seat Ht: 16.5" - 21.5" Back: 19" W x 24" H COM: .75 yd. COL: 15 sq. ft. 40 lbs.	Black Nylon	859	889	910	922	943	965	985	1,006	1,026	1,048	1,145	1,216
		Polished Aluminum	938	968	989	1,001	1,022	1,044	1,064	1,085	1,105	1,127	1,224	1,295
4494-K 	Mesh-Back, Cantilever Arms 23.5" W x 23" D x 38.5" - 43.5" H Seat: 19" W x 18.5" D Seat Ht: 16.5" - 21.5" Back: 19" W x 24" H COM: .75 yd. COL: 15 sq. ft. 37 lbs.	Black Nylon	859	889	910	922	943	965	985	1,006	1,026	1,048	1,145	1,216
		Polished Aluminum	938	968	989	1,001	1,022	1,044	1,064	1,085	1,105	1,127	1,224	1,295

OPTIONS

-HR01	Headrest	\$103
-W02	White Back Frame	\$78
-PCA01	Polished Cantilever Arms	\$125
-SS02	Seat Slider	\$76
-STC02	Soft Tread Casters	\$26
-STLC02	Soft Tread Self-Locking Casters	\$52
-GD04	Glides	\$26
-J01	Jury Base (black only)	\$150



All shipments for this series will be cartoned as standard. If blanket-wrapped shipping is required, please contact client services for additional information.

PROPEL | Designed by Baldanzi & Novelli

Weight-Activated Mechanism

ORDERING REQUIREMENTS:

- Model number
- Back shell color
- Arm color
- Base finish
- Upholstery selection
- Options, as applicable

MODEL	PRODUCT SPECIFICATIONS	BASE FINISH	FABRIC GRADES								LEATHER			
			COM	A	1	2	3	4	COL 5	6	7	8	L1	L2
4421-U 	Upholstered Back, Armless 20" W x 23" D x 39" - 44" H Seat: 19" W x 18.5" D Seat Ht: 17" - 22" Back: 19" W x 24" H COM: 1.5 yds. COL: 30 sq. ft. 36 lbs.	Black Nylon	876	936	978	1,002	1,044	1,088	1,128	1,170	1,209	1,253	1,448	1,590
		Polished Aluminum	955	1,015	1,057	1,081	1,123	1,167	1,207	1,249	1,288	1,332	1,527	1,669
4423-U 	Upholstered Back, Adjustable T-Arms 25" W x 23" D x 39" - 44" H Seat: 19" W x 18.5" D Seat Ht: 17" - 22" Back: 19" W x 24" H COM: 1.5 yds. COL: 30 sq. ft. 40 lbs.	Black Nylon	922	982	1,024	1,048	1,090	1,134	1,174	1,216	1,255	1,299	1,494	1,636
		Polished Aluminum	1,001	1,061	1,103	1,127	1,169	1,213	1,253	1,295	1,334	1,378	1,573	1,715
4424-U 	Upholstered Back, Cantilever Arms 23.5" W x 23" D x 39" - 44" H Seat: 19" W x 18.5" D Seat Ht: 17" - 22" Back: 19" W x 24" H COM: 1.5 yds. COL: 30 sq. ft. 40 lbs.	Black Nylon	922	982	1,024	1,048	1,090	1,134	1,174	1,216	1,255	1,299	1,494	1,636
		Polished Aluminum	1,001	1,061	1,103	1,127	1,169	1,213	1,253	1,295	1,334	1,378	1,573	1,715

OPTIONS

-HR01	Headrest	\$103
-W02	White Back Frame	\$78
-PCA01	Polished Cantilever Arms	\$125
-SS01	Seat Slider	\$76
-STC02	Soft Tread Casters	\$26
-STLC02	Soft Tread Self-Locking Casters	\$52
-GD04	Glides	\$26
-J01	Jury Base (black only)	\$150



All shipments for this series will be cartoned as standard. If blanket-wrapped shipping is required, please contact client services for additional information.

PROPEL | Designed by Baldanzi & Novelli

Synchro-Tilt Mechanism

ORDERING REQUIREMENTS:

- Model number
- Back shell color
- Arm color
- Base finish
- Upholstery selection
- Options, as applicable

MODEL	PRODUCT SPECIFICATIONS	BASE FINISH	FABRIC GRADES								LEATHER			
			COM	A	1	2	3	4	COL 5	6	7	8	L1	L2
4491-U 	Upholstered Back, Armless 20" W x 23" D x 38.5" - 43.5" H Seat: 19" W x 18.5" D Seat Ht: 16.5" - 21.5" Back: 19" W x 24" H COM: 1.5 yds. COL: 30 sq. ft. 33 lbs.	Black Nylon	833	893	935	959	1,001	1,045	1,085	1,127	1,166	1,210	1,405	1,547
		Polished Aluminum	912	972	1,014	1,038	1,080	1,124	1,164	1,206	1,245	1,289	1,484	1,626
4493-U 	Upholstered Back, Adjustable T-Arms 25" W x 23" D x 38.5" - 43.5" H Seat: 19" W x 18.5" D Seat Ht: 16.5" - 21.5" Back: 19" W x 24" H COM: 1.5 yds. COL: 30 sq. ft. 40 lbs.	Black Nylon	877	937	979	1,003	1,045	1,089	1,129	1,171	1,210	1,254	1,449	1,591
		Polished Aluminum	956	1,016	1,058	1,082	1,124	1,168	1,208	1,250	1,289	1,333	1,528	1,670
4494-U 	Upholstered Back, Cantilever Arms 23.5" W x 23" D x 38.5" - 43.5" H Seat: 19" W x 18.5" D Seat Ht: 16.5" - 21.5" Back: 19" W x 24" H COM: 1.5 yds. COL: 30 sq. ft. 37 lbs.	Black Nylon	877	937	979	1,003	1,045	1,089	1,129	1,171	1,210	1,254	1,449	1,591
		Polished Aluminum	956	1,016	1,058	1,082	1,124	1,168	1,208	1,250	1,289	1,333	1,528	1,670

OPTIONS

-HR01	Headrest	\$103
-W02	White Back Frame	\$78
-PCA01	Polished Cantilever Arms	\$125
-SS02	Seat Slider	\$76
-STC02	Soft Tread Casters	\$26
-STC02	Soft Tread Self-Locking Casters	\$52
-GD04	Glides	\$26
-J01	Jury Base (black only)	\$150

All shipments for this series will be blanket-wrapped as standard. If cartoning is required, a 5% upcharge will be added to each product. Please contact client services for additional information.

RECESS® GUEST



SPECIFICATIONS:

- Fully upholstered and mesh suspension back models.
- Mesh suspension available in three colors. Please refer to listing below.
- Arm and armless options.
- Arm model features black polypropylene arm cap.
- Frame available in standard and premium finishes. See below for options.
- For custom metal finish colors, please contact client services for pricing.
- Stacks 6-high from floor.
- Chairs are packaged three (3) to a carton.
- \$20 List carton break charge for less than three (3) chairs.
- Orders for thirty (30) or more chairs will not be subject to carton break upcharge.
- 300 lb. weight capacity.
- All dimensions are nominal.
- Refer to terms and conditions for general information regarding fabrics, finishes, warranty, freight, complete condition of sales and more.

STANDARD METAL FRAME FINISH COLORS:

- #06 Charcoal Grey
- #90 Metallic Silver

PREMIUM METAL FRAME FINISH COLORS:

- #07 Gold Shimmer
- #08 Penny
- #09 Brown Sugar
- #83 Metallic Champagne
- #94 Cotton

MESH SUSPENSION COLORS:

- #107 Sterling
- #109 Night
- #126 Wheat

All shipments for this series will be blanket-wrapped as standard. If cartoning is required, a 5% upcharge will be added to each product. Please contact client services for additional information.



RECESS® GUEST



(#90 Metallic Silver frame finish only)

ORDERING REQUIREMENTS:

- Model number
- Mesh suspension color
- Frame finish
- Seat upholstery selection
- Options, as applicable

MODEL	PRODUCT SPECIFICATIONS	FABRIC GRADES										LEATHER	
		COM	A	1	2	3	4	COL 5	6	7	8	L1	L2
2212 	Mesh Back, Upholstered Seat, Arms 22" W x 25" D x 33" H Seat: 19.5" W x 20" D Seat Ht: 18" Arm Ht: 25.75" COM: .75 yd. COL: 15 sq. ft. 25 lbs.	422	452	473	485	506	528	548	569	589	611	708	779
2232 	Mesh Back, Upholstered Seat, Armless 21" W x 25" D x 33" H Seat: 19.5" W x 20" D Seat Ht: 18" COM: .75 yd. COL: 15 sq. ft. 23 lbs.	393	423	444	456	477	499	519	540	560	582	679	750

OPTIONS

- PF02 Premium Metal Frame Finish \$80
- FS01 1" Additional Seat Foam \$30
- GC08 Ganging Bracket \$30
- VCT04 VCT Tile Glides \$24

All shipments for this series will be blanket-wrapped as standard. If cartoning is required, a 5% upcharge will be added to each product. Please contact client services for additional information.



RECESS® GUEST



(#90 Metallic Silver frame finish only)

ORDERING REQUIREMENTS:

- Model number
- Frame finish
- Upholstery selection
- Options, as applicable

MODEL	PRODUCT SPECIFICATIONS	FABRIC GRADES								LEATHER			
		COM	A	1	2	3	4	COL 5	6	7	8	L1	L2
2210 	Fully Upholstered, Arms 22" W x 25" D x 33" H Seat: 19.5" W x 20" D Seat Ht: 18" Arm Ht: 25.75" COM: 1.5 yds. COL: 30 sq. ft. 25 lbs.	428	488	530	554	596	640	680	722	761	805	1,000	1,142
2230 	Fully Upholstered, Armless 21" W x 25" D x 33" H Seat: 19.5" W x 20" D Seat Ht: 18" COM: 1.5 yds. COL: 30 sq. ft. 23 lbs.	399	459	501	525	567	611	651	693	732	776	971	1,113

OPTIONS

-PF02	Premium Metal Frame Finish	\$80
-FS01	1" Additional Seat Foam	\$30
-GC08	Ganging Bracket	\$30
-VCT04	VCT Tile Glides	\$24

SIGNAL® GUEST | Licensed from Wiesner Hager - Austria



SPECIFICATIONS:

- Fully upholstered and wood back models.
- Arm and armless options.
- Arms available in wood or black polypropylene.
- Wood back and arms offered in all standard finishes on beech. Please refer to standard finish card.
- For custom wood finishes, please add \$450 List per color per order.
- Wood arm finish will match wood back finish unless specified otherwise.
- 1" square steel frame.
- Frame available in standard and premium finishes. Please refer to listing below.
- Chairs stack up to 5 high standing.
- Fully upholstered cantilever frame model with horizontal stitching detail also available.
- Cantilever model features 1.25" wide x .75" thick rectangular steel frame and black leather soft-touch arm caps.
- Optional felt glides for hard surface flooring (cantilever model only).
- 350 lb. weight capacity.
- All dimensions are nominal.
- Refer to terms and conditions for general information regarding fabrics, finishes, warranty, freight, complete condition of sales and more.

STANDARD METAL FRAME FINISH COLORS:

- #06 Charcoal Grey
- #90 Metallic Silver
- #91 Chrome
- #95 Satin Black

PREMIUM METAL FRAME FINISH COLORS:



- #07 Gold Shimmer
- #08 Penny
- #09 Brown Sugar
- #83 Metallic Champagne
- #94 Cotton

All shipments for this series will be blanket-wrapped as standard. If cartoning is required, a 5% upcharge will be added to each product. Please contact client services for additional information.

SIGNAL® GUEST | Licensed from Wiesner Hager - Austria

ORDERING REQUIREMENTS:

- Model number
- Wood arm finish, as applicable
- Frame finish
- Upholstery selection
- Options, as applicable

MODEL	PRODUCT SPECIFICATIONS	FABRIC GRADES										LEATHER	
		COM	A	1	2	3	4	COL 5	6	7	8	L1	L2
3510-W 	Guest Chair, Fully Upholstered, Wood Arms 22.75" W x 21" D x 31.75" H Seat: 18" W x 16.5" D Seat Ht: 18.5" Arm Ht: 25.5" COM: 1.25 yds. COL: 25 sq. ft. 20 lbs.	791	841	876	896	931	968	1,001	1,036	1,069	1,105	1,268	1,386
3510-P 	Guest Chair, Fully Upholstered, Polypropylene Arms 22.75" W x 21" D x 31.75" H Seat: 18" W x 16.5" D Seat Ht: 18.5" Arm Ht: 25.5" COM: 1.25 yds. COL: 25 sq. ft. 20 lbs.	787	837	872	892	927	964	997	1,032	1,065	1,101	1,264	1,382
3530 	Guest Chair, Fully Upholstered, Armless 19.75" W x 21" D x 31.75" H Seat: 18" W x 16.5" D Seat Ht: 18.5" COM: 1.25 yds. COL: 25 sq. ft. 19 lbs.	651	701	736	756	791	828	861	896	929	965	1,128	1,246

OPTIONS



- PF02 Premium Metal Frame Finish \$80
- GC09 Ganging Connector \$42

All shipments for this series will be blanket-wrapped as standard. If cartoning is required, a 5% upcharge will be added to each product. Please contact client services for additional information.

SIGNAL® GUEST | Licensed from Wiesner Hager - Austria

ORDERING REQUIREMENTS:

- Model number
- Wood finish
- Frame finish
- Upholstery selection
- Options, as applicable

MODEL	PRODUCT SPECIFICATIONS	FABRIC GRADES								LEATHER			
		COM	A	1	2	3	4	COL 5	6	7	8	L1	L2
3511-W 	Guest Chair, Wood Back Wood Arms 22.75" W x 23.25" D x 31.75" H Seat: 18" W x 18" D Seat Ht: 18.5" Arm Ht: 25.5" COM: .75 yd. COL: 15 sq. ft. 19 lbs.	906	936	957	969	990	1,012	1,032	1,053	1,073	1,095	1,192	1,263
3511-P 	Guest Chair, Wood Back, Polypropylene Arms 22.75" W x 23.25" D x 31.75" H Seat: 18" W x 18" D Seat Ht: 18.5" Arm Ht: 25.5" COM: .75 yd. COL: 15 sq. ft. 19 lbs.	864	894	915	927	948	970	990	1,011	1,031	1,053	1,150	1,221
3531 	Guest Chair, Wood Back, Armless 19.75" W x 23.25" D x 31.75" H Seat: 18" W x 18" D Seat Ht: 18.5" COM: .75 yd. COL: 15 sq. ft. 18 lbs.	755	785	806	818	839	861	881	902	922	944	1,041	1,112

OPTIONS

- PF02 Premium Metal Frame Finish \$80
- GC09 Ganging Connector \$42

All shipments for this series will be blanket-wrapped as standard. If cartoning is required, a 5% upcharge will be added to each product. Please contact client services for additional information.

SIGNAL® GUEST | Licensed from Wiesner Hager - Austria

ORDERING REQUIREMENTS:

- Model number
- Frame finish
- Upholstery selection
- Options, as applicable

MODEL	PRODUCT SPECIFICATIONS	FABRIC GRADES										LEATHER	
		COM	A	1	2	3	4	COL 5	6	7	8	L1	L2
3520 	Guest Chair, Arms Cantilever Frame 22" W x 23" D x 35" H Seat: 19.5" W x 18.75" D Seat Ht: 18" Arm Ht: 26" COM: 2 yds. COL: 40 sq. ft. 28 lbs.	1,170	1,250	1,306	1,338	1,394	1,452	1,506	1,562	1,614	1,672	1,932	2,122

OPTIONS

- PF02 Premium Metal Frame Finish \$80
- FG04 Felt Glides \$40

All shipments for this series will be cartoned as standard. If blanket-wrapped shipping is required, please contact client services for additional information.

SIMPLEX

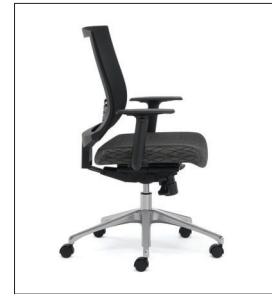

SPECIFICATIONS:

- Breathable mesh suspension back and fully upholstered seat.
- Mesh suspension available in three colors. Please refer to listing below.
- Armless, adjustable t-arm and cantilever arm models.
- Adjustable t-arm features 4" arm height adjustment as standard.
- Adjustable lumbar support.
- Two mechanism options: swivel-tilt with tilt-lock and built-in seat slider or synchro-tilt. Refer to pages 13-15 for mechanism guide.
- Two base options: black nylon and polished aluminum.
- 300 lb. weight capacity.
- Ships KD (knocked down).
- All dimensions are nominal.
- Refer to terms and conditions for general information regarding fabrics, finishes, warranty, freight, complete condition of sales and more.

MESH SUSPENSION COLORS:

- #107 Sterling
- #109 Night
- #126 Wheat

All shipments for this series will be cartoned as standard. If blanket-wrapped shipping is required, please contact client services for additional information.



SIMPLEX



Swivel-Tilt with Tilt Lock and Seat Slider Mechanism

ORDERING REQUIREMENTS:

- Model number
- Mesh suspension color
- Base finish
- Upholstery selection
- Options, as applicable

MODEL	PRODUCT SPECIFICATIONS	BASE FINISH	FABRIC GRADES										LEATHER	
			COM	A	1	2	3	4	COL 5	6	7	8	L1	L2
4051 	Armless 21" W x 22" D x 37" - 42" H Seat: 19.5" W x 18.5" D Seat Ht: 17" - 22" Back: 18.5" W x 21" H COM: 1 yd. COL: 20 sq. ft. 34 lbs.	Black Nylon	774	814	842	858	886	915	942	970	996	1,025	1,155	1,250
		Polished Aluminum	853	893	921	937	965	994	1,021	1,049	1,075	1,104	1,234	1,329
4053 	Adjustable T-Arms 25" W x 22" D x 37" - 42" H Seat: 19.5" W x 18.5" D Seat Ht: 17" - 22" Back: 18.5" W x 21" H COM: 1 yd. COL: 20 sq. ft. 38 lbs.	Black Nylon	873	913	941	957	985	1,014	1,041	1,069	1,095	1,124	1,254	1,349
		Polished Aluminum	952	992	1,020	1,036	1,064	1,093	1,120	1,148	1,174	1,203	1,333	1,428
4054 	Cantilever Arms 25" W x 22" D x 37" - 42" H Seat: 19.5" W x 18.5" D Seat Ht: 17" - 22" Back: 18.5" W x 21" H COM: 1 yd. COL: 20 sq. ft. 38 lbs.	Black Nylon	834	874	902	918	946	975	1,002	1,030	1,056	1,085	1,215	1,310
		Polished Aluminum	913	953	981	997	1,025	1,054	1,081	1,109	1,135	1,164	1,294	1,389

OPTIONS

-WA01	Width Adjustable Arms	\$30
-STC02	Soft Tread Casters	\$26
-GD04	Glides	\$26
-J01	Jury Base (black only)	\$150
-SK01	Stool Kit [†]	\$90

[†] Tilt function is disabled on stool models.

All shipments for this series will be cartoned as standard. If blanket-wrapped shipping is required, please contact client services for additional information.



SIMPLEX



Synchro-Tilt Mechanism

ORDERING REQUIREMENTS:

- Model number
- Mesh suspension color
- Base finish
- Upholstery selection
- Options, as applicable

MODEL	PRODUCT SPECIFICATIONS	BASE FINISH	FABRIC GRADES										LEATHER	
			COM	A	1	2	3	4	COL 5	6	7	8	L1	L2
4091 	Armless 21" W x 22" D x 37" - 42" H Seat: 19.5" W x 18.5" D Seat Ht: 17" - 22" Back: 18.5" W x 21" H COM: 1 yd. COL: 20 sq. ft. 34 lbs.	Black Nylon	808	848	876	892	920	949	976	1,004	1,030	1,059	1,189	1,284
		Polished Aluminum	887	927	955	971	999	1,028	1,055	1,083	1,109	1,138	1,268	1,363
4093 	Adjustable T-Arms 25" W x 22" D x 37" - 42" H Seat: 19.5" W x 18.5" D Seat Ht: 17" - 22" Back: 18.5" W x 21" H COM: 1 yd. COL: 20 sq. ft. 38 lbs.	Black Nylon	912	952	980	996	1,024	1,053	1,080	1,108	1,134	1,163	1,293	1,388
		Polished Aluminum	991	1,031	1,059	1,075	1,103	1,132	1,159	1,187	1,213	1,242	1,372	1,467
4094 	Cantilever Arms 25" W x 22" D x 37" - 42" H Seat: 19.5" W x 18.5" D Seat Ht: 17" - 22" Back: 18.5" W x 21" H COM: 1 yd. COL: 20 sq. ft. 38 lbs.	Black Nylon	872	912	940	956	984	1,013	1,040	1,068	1,094	1,123	1,253	1,348
		Polished Aluminum	951	991	1,019	1,035	1,063	1,092	1,119	1,147	1,173	1,202	1,332	1,427

OPTIONS

-WA01	Width Adjustable Arms	\$30
-STC02	Soft Tread Casters	\$26
-GD04	Glides	\$26
-J01	Jury Base (black only)	\$150

SKYLINE MEETING TABLES



SPECIFICATIONS:

- Round and square top shapes.
- 29" and 42" table heights. Custom heights between 29" and 42" available. Please specify and add \$150 List per unit. Price is based on the higher standard table height (e.g. 32" custom height, price is based on the 42" standard height plus \$150).
- Laminate, solid surface and back-painted glass top surfaces.
- Laminate and solid surface tops feature an exposed wood edge.
- Glass tops are back-painted white as standard and feature a wood substrate.
- Laminate available in all standard colors. Please refer to standard finish card.
- For custom laminate options, add \$550 List per color per order. Pre-approval required, please contact client services.
- Solid surface available in white only.
- Laminate tops are 3/4" thick, back-painted glass and solid surface tops are 1" thick.
- Back-painted glass may be used as a writable surface with dry-erase markers.
- Metal column and base plate available in standard and premium finishes. Please refer to listing below.
- For custom metal finish colors, please contact client services for pricing.
- All dimensions are nominal.
- Refer to terms and conditions for general information regarding finishes, warranty, freight, complete condition of sales and more.

EDGE DETAIL:

Laminate* Top

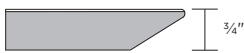

Glass Top



Solid Surface Top



*Please note that laminate thickness is nominal and may vary.

SQUARE TOP SHAPE:

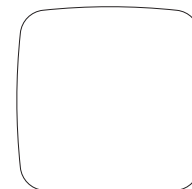

STANDARD METAL BASE FINISH COLORS:

- #06 Charcoal Grey
- #90 Metallic Silver
- #91 Chrome
- #95 Satin Black

PREMIUM METAL BASE FINISH COLORS:

- #07 Gold Shimmer
- #08 Penny
- #09 Brown Sugar
- #83 Metallic Champagne
- #94 Cotton

All shipments for this series will be blanket-wrapped as standard. If cartoning is required, a 5% upcharge will be added to each product. Please contact client services for additional information.

SKYLINE MEETING TABLES

ORDERING REQUIREMENTS:

- Model number
- Top surface
- Top finish, as applicable
- Column/base plate finish
- Options, as applicable

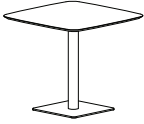
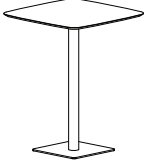
MODEL	LAMINATE (-L)	SOLID SURFACE (-SF)	GLASS (-GL)	COLUMN DIAMETER	BASE PLATE DIMENSIONS	WEIGHT	
 <p>Square Top, 29" Height</p>	7100-323229-()	1,515	2,049	1,859	3"	18" Square	68 lbs.
	7100-363629-()	1,701	2,376	2,104	3"	22" Square	76 lbs.
	7100-424229-()	1,926	2,845	2,385	3"	22" Square	85 lbs.
	7100-484829-()	2,253	3,453	2,768	4"	22" Square	91 lbs.
 <p>Square Top, 42" Height</p>	7100-323242-()	1,571	2,105	1,915	3"	18" Square	74 lbs.
	7100-363642-()	1,759	2,434	2,158	3"	22" Square	82 lbs.

OPTIONS

-PF02 Premium Metal Base Finish \$80

All shipments for this series will be blanket-wrapped as standard. If cartoning is required, a 5% upcharge will be added to each product. Please contact client services for additional information.

SKYLINE MEETING TABLES

ORDERING REQUIREMENTS:

- Model number
- Top surface
- Top finish, as applicable
- Column/base plate finish
- Options, as applicable

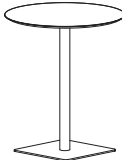
MODEL	LAMINATE (-L)	SOLID SURFACE (-SF)	GLASS (-GL)	COLUMN DIAMETER	BASE PLATE DIMENSIONS	WEIGHT	
 <p>Round Top, 29" Height</p>	7101-2929-()	1,545	1,889	1,891	3"	18" Square	68 lbs.
	7101-3629-()	1,859	2,534	2,260	3"	22" Square	76 lbs.
	7101-4229-()	1,918	2,837	2,377	3"	22" Square	85 lbs.
	7101-4829-()	1,977	3,177	2,493	4"	22" Square	91 lbs.
 <p>Round Top, 42" Height</p>	7101-2942-()	1,601	1,945	1,945	3"	18" Square	74 lbs.
	7101-3642-()	1,915	2,590	2,317	3"	22" Square	82 lbs.

OPTIONS

-PF02 Premium Metal Base Finish \$80

SKYLINE OCCASIONAL TABLES



SPECIFICATIONS:

- Round and square top shapes.
- 16" and 18" table heights.
- Laminate, solid surface and back-painted glass top surfaces.
- Laminate and solid surface tops feature an exposed wood edge.
- Glass tops are back-painted white as standard and feature a wood substrate.
- Laminate available in all standard colors. Please refer to standard finish card.
- For custom laminate options, add \$550 List per color per order. Pre-approval required, please contact client services.
- Solid surface available in white only.
- Laminate tops are 3/4" thick, back-painted glass and solid surface tops are 1" thick.
- Back-painted glass may be used as a writable surface with dry-erase markers.
- Metal column and base plate available in standard and premium finishes. Please refer to listing below.
- For custom metal finish colors, please contact client services for pricing.
- All dimensions are nominal.
- Refer to terms and conditions for general information regarding finishes, warranty, freight, complete condition of sales and more.

EDGE DETAIL:

Laminate* Top

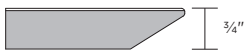

Glass Top



Solid Surface Top



*Please note that laminate thickness is nominal and may vary.

SQUARE TOP SHAPE:

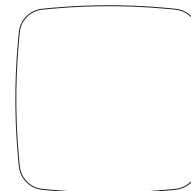

STANDARD METAL BASE FINISH COLORS:

- #06 Charcoal Grey
- #90 Metallic Silver
- #91 Chrome
- #95 Satin Black

PREMIUM METAL BASE FINISH COLORS:

- #07 Gold Shimmer
- #08 Penny
- #09 Brown Sugar
- #83 Metallic Champagne
- #94 Cotton

All shipments for this series will be blanket-wrapped as standard. If cartoning is required, a 5% upcharge will be added to each product. Please contact client services for additional information.

SKYLINE OCCASIONAL TABLES

ORDERING REQUIREMENTS:

- Model number
- Top surface
- Top finish, as applicable
- Column/base plate finish
- Options, as applicable

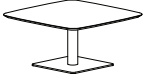
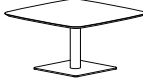
MODEL	LAMINATE (-L)	SOLID SURFACE (-SF)	GLASS (-GL)	COLUMN DIAMETER	BASE PLATE DIMENSIONS	WEIGHT	
 <p>Square Top, 16" Height</p>	7100-181816-()	837	961	1,009	3"	14" Square	19 lbs.
	7100-222216-()	1,001	1,221	1,230	3"	14" Square	30 lbs.
	7100-323216-()	1,382	1,916	1,726	3"	18" Square	52 lbs.
	7100-363616-()	1,568	2,243	1,971	3"	22" Square	58 lbs.
	7100-424216-()	1,793	2,712	2,253	3"	22" Square	66 lbs.
	7100-484816-()	2,119	3,319	2,634	3"	22" Square	72 lbs.
 <p>Square Top, 18" Height</p>	7100-181818-()	878	1,002	1,051	3"	14" Square	22 lbs.
	7100-222218-()	1,043	1,263	1,272	3"	14" Square	33 lbs.
	7100-323218-()	1,423	1,957	1,767	3"	18" Square	55 lbs.
	7100-363618-()	1,610	2,285	2,011	3"	22" Square	61 lbs.
	7100-424218-()	1,834	2,753	2,292	3"	22" Square	69 lbs.
	7100-484818-()	2,160	3,360	2,676	4"	22" Square	75 lbs.

OPTIONS



-PF02 Premium Metal Base Finish \$80

All shipments for this series will be blanket-wrapped as standard. If cartoning is required, a 5% upcharge will be added to each product. Please contact client services for additional information.

SKYLINE OCCASIONAL TABLES

ORDERING REQUIREMENTS:

- Model number
- Top surface
- Top finish, as applicable
- Column/base plate finish
- Options, as applicable

MODEL	LAMINATE (-L)	SOLID SURFACE (-SF)	GLASS (-GL)	COLUMN DIAMETER	BASE PLATE DIMENSIONS	WEIGHT	
 <p>Round Top, 16" Height</p>	7101-1916-()	892	1,030	1,064	3"	14" Square	19 lbs.
	7101-2116-()	944	1,113	1,174	3"	14" Square	30 lbs.
	7101-2916-()	1,414	1,758	1,758	3"	18" Square	52 lbs.
	7101-3616-()	1,726	2,401	2,127	3"	22" Square	58 lbs.
	7101-4216-()	1,785	2,704	2,244	3"	22" Square	66 lbs.
	7101-4816-()	1,845	3,045	2,360	3"	22" Square	72 lbs.
 <p>Round Top, 18" Height</p>	7101-1918-()	935	1,073	1,106	3"	14" Square	22 lbs.
	7101-2118-()	985	1,154	1,215	3"	14" Square	33 lbs.
	7101-2918-()	1,454	1,798	1,799	3"	18" Square	55 lbs.
	7101-3618-()	1,767	2,442	2,169	3"	22" Square	61 lbs.
	7101-4218-()	1,827	2,746	2,285	3"	22" Square	69 lbs.
	7101-4818-()	1,885	3,085	2,400	4"	22" Square	75 lbs.

OPTIONS

-PF02 Premium Metal Base Finish \$80

STRING GAMES MEETING TABLES | Designed by Madsen & Contois



SPECIFICATIONS:

- Available in two heights: 29" and 42".
- Depth options include: 24", 30" and 36".
- Length sizes include: 60", 72", 84" and 96".
- Tables offered in wood veneer, laminate and solid surface.
- Solid surface available in white only.
- To order a non-standard solid surface color, please specify the manufacturer, pattern name and color number. Please contact client services to confirm pricing.
- **Interior and exterior metal accents are featured as standard.**
- Also offered without interior and exterior metal accents, in various combinations, at no charge. Please refer to specific pages for options.
- Metal accents available in standard and premium finishes. See following page for options.
- For custom metal finish colors, please contact client services for pricing.
- Tables feature black reveal between top edge of panels and table-top.
- When specifying white laminate or solid surface, reveal will be white.
- For tables intended to be placed end-to-end, please select applicable option code without exterior metal accents (-MA0) or with exterior metal accent on single side only. (-MA3)
- Panel bases and underside of tables feature removable panels for wire management accessibility.
- All panel bases feature adjustable glides as standard for leveling purposes.
- Ships KD. Assembly required.
- To ship fully assembled, set-up charge will be \$500 List per unit.
- Optional power units available. Please refer to pages 260-263 for options.
- All dimensions are nominal.
- Refer to terms and conditions for general information regarding finishes, warranty, freight, complete condition of sales and more.

VENEER TABLE FEATURES:

- Three wood species available: Ash, Maple and Walnut.
- For custom wood finishes, please contact client services and add one-time upcharge of \$450 List per color per order.
- Due to natural variations of grain and color in woods, slight variations may occur.
- Veneer direction will run lengthwise on all table sizes.
- Edge finish will match top finish unless specified otherwise.

STRING GAMES MEETING TABLES | Designed by Madsen & Contois

LAMINATE TABLE FEATURES:

- Laminate available in all standard colors.
- If white laminate is desired for top and panel bases, it is recommended to utilize Formica 949-58 White Matte with a ColorCore® 2 edge detail in matching 949C-58 White Matte to eliminate the black line that occurs with traditional laminates. Please specify and add \$300 List to the laminate pricing column.
- For custom laminate options, add \$550 List per color per order. Pre-approval required, please contact client services.
- Laminate wood grain direction will run lengthwise on all table sizes.
- Self edge standard, unless otherwise specified (laminate applied to edge).

SOLID SURFACE TABLE FEATURES:

- Solid surface is affixed to table top only (not available on table edges or panel bases). Please note that a 1/8" reveal will be present.
- Solid surface available in white only.
- To order a non-standard solid surface color, please specify the manufacturer, pattern name and color number. Contact client services to confirm pricing.
- Please specify wood or laminate finish for the table interior surface and panel bases, which will also be applied to the edge.

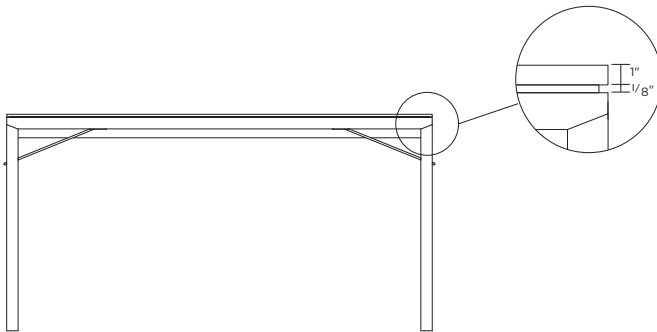

Standard Metal Accent Finish Colors:

- #06 Charcoal Grey
- #90 Metallic Silver
- #91 Chrome
- #95 Satin Black

Premium Metal Accent Finish Colors:

- #07 Gold Shimmer
- #08 Penny
- #09 Brown Sugar
- #83 Metallic Champagne
- #94 Cotton

All shipments for this series will be blanket-wrapped as standard. If cartoning is required, a 5% upcharge will be added to each product. Please contact client services for additional information.

STRING GAMES MEETING TABLES | Designed by Madsen & Contois

ORDERING REQUIREMENTS:

- Model number
- Surface material
- Surface finish
- Metal accent finish
- Options, as applicable

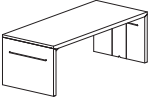
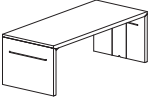
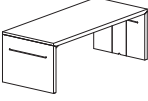
MODEL	DIMENSIONS	MAPLE VENEER OR LAMINATE	ASH OR WALNUT VENEER	SOLID SURFACE <small>Add upcharge to applicable wood species column</small>	WEIGHT <small>For veneer, laminate and ColorCore 2 tables only</small>	
 Interior/Exterior Metal Accents 24" Depth, 29" Height	8122-246029-()	24" D x 60" L x 29" H	3,998	4,839	750	149 lbs.
	8122-247229-()	24" D x 72" L x 29" H	4,333	5,304	900	165 lbs.
	8122-248429-()	24" D x 84" L x 29" H	4,564	5,540	1,050	172 lbs.
	8122-249629-()	24" D x 96" L x 29" H	4,768	5,750	1,200	179 lbs.
 Interior/Exterior Metal Accents 30" Depth, 29" Height	8122-306029-()	30" D x 60" L x 29" H	4,498	5,593	938	160 lbs.
	8122-307229-()	30" D x 72" L x 29" H	4,708	5,803	1,125	176 lbs.
	8122-308429-()	30" D x 84" L x 29" H	4,949	6,050	1,313	182 lbs.
	8122-309629-()	30" D x 96" L x 29" H	5,183	6,289	1,500	190 lbs.
 Interior/Exterior Metal Accents 36" Depth, 29" Height	8122-366029-()	36" D x 60" L x 29" H	4,442	5,289	1,125	171 lbs.
	8122-367229-()	36" D x 72" L x 29" H	4,843	5,819	1,350	187 lbs.
	8122-368429-()	36" D x 84" L x 29" H	5,115	6,096	1,575	193 lbs.
	8122-369629-()	36" D x 96" L x 29" H	5,354	6,336	1,800	202 lbs.

OPTIONS

-PF02	Premium Metal Finish	\$80
-MA0	No Metal Accents	n/c
-MA2	Interior Metal Accents Only	n/c
-MA3	Interior Metal Accents - Both Sides Exterior Metal Accent - Single Side	n/c

MA0



No Metal Accents

MA2



Interior Metal Accents Only

MA3



Interior Metal Accents - Both Sides
Exterior Metal Accents - Single Side

All shipments for this series will be blanket-wrapped as standard. If cartoning is required, a 5% upcharge will be added to each product. Please contact client services for additional information.

STRING GAMES MEETING TABLES | Designed by Madsen & Contois

ORDERING REQUIREMENTS:

- Model number
- Surface material
- Surface finish
- Metal accent finish
- Options, as applicable

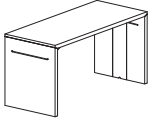
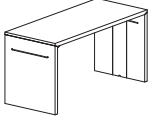
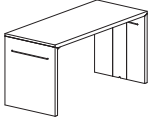
MODEL	DIMENSIONS	MAPLE VENEER OR LAMINATE	ASH OR WALNUT VENEER	SOLID SURFACE <small>Add upcharge to applicable wood species column</small>	WEIGHT <small>For veneer, laminate and ColorCore 2 tables only</small>	
 <p>Interior/Exterior Metal Accents 24" Depth, 42" Height</p>	8122-246042-()	24" D x 60" L x 42" H	4,612	5,712	750	157 lbs.
	8122-247242-()	24" D x 72" L x 42" H	4,816	5,922	900	173 lbs.
	8122-248442-()	24" D x 84" L x 42" H	5,029	6,135	1,050	180 lbs.
	8122-249642-()	24" D x 96" L x 42" H	5,233	6,344	1,200	189 lbs.
 <p>Interior/Exterior Metal Accents 30" Depth, 42" Height</p>	8122-306042-()	30" D x 60" L x 42" H	5,350	6,947	938	168 lbs.
	8122-307242-()	30" D x 72" L x 42" H	5,590	7,192	1,125	184 lbs.
	8122-308442-()	30" D x 84" L x 42" H	5,831	7,440	1,313	190 lbs.
	8122-309642-()	30" D x 96" L x 42" H	6,041	7,649	1,500	199 lbs.
 <p>Interior/Exterior Metal Accents 36" Depth, 42" Height</p>	8122-366042-()	36" D x 60" L x 42" H	5,966	7,941	1,125	179 lbs.
	8122-367242-()	36" D x 72" L x 42" H	6,211	8,186	1,350	195 lbs.
	8122-368442-()	36" D x 84" L x 42" H	6,489	8,470	1,575	201 lbs.
	8122-369642-()	36" D x 96" L x 42" H	6,758	8,745	1,800	211 lbs.

OPTIONS

-PF02	Premium Metal Finish	\$80
-MA0	No Metal Accents	n/c
-MA2	Interior Metal Accents Only	n/c
-MA3	Interior Metal Accents - Both Sides Exterior Metal Accent - Single Side	n/c

MA0



No Metal Accents

MA2



Interior Metal Accents Only

MA3



Interior Metal Accents - Both Sides
Exterior Metal Accents - Single Side

All shipments for this series will be blanket-wrapped as standard. If cartoning is required, a 5% upcharge will be added to each product. Please contact client services for additional information.

STRING GAMES MEETING TABLES - POWER UNITS | Designed by Madsen & Contois

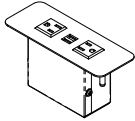

- Unit below is corded and available for top surface and/or side-mount placement. Refer to pages 261-262 for daisy chain options.
- Side-mount placement available on outside of panel bases and can only be added to tables without exterior metal accent. Power unit will be positioned vertically and includes matching wood cover on panel base interior.
- Please specify if power unit is to be placed on table top or outside base panel.
- Cord length should be taken into account when specifying electrical placement.
- Power source location must be identified.
- For single power unit placed on table top, location will be centered as standard.
- For panel base placement, refer to page 262 for power unit standard locations.
- Panel bases and underside of tables feature removable panels for wire management accessibility.
- To add power cord exit to the exterior base panel, please specify -"PC02" and add \$75 List.

MODEL	DESCRIPTION	LIST
<p>PB3-S, Silver Finish PB3-W, White Finish</p> 	<p>Power Band 3</p> <ul style="list-style-type: none"> ■ Dimensions: 6.5" W x 2.5" D ■ Two (2) simplex outlets and two (2) USB charging ports. ■ 108" electrical cord. ■ UL listed. 	<p>510</p>

All shipments for this series will be blanket-wrapped as standard. If cartoning is required, a 5% upcharge will be added to each product. Please contact client services for additional information.

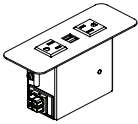

STRING GAMES MEETING TABLES - DAISY CHAIN COMPONENTS | Designed by Madsen & Contois

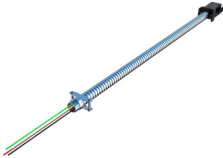
- Daisy chain units are required when more than one electrical unit is specified on one top.
- To determine jumper cable length, measure length from edge of electrical unit to end of table.
- Every connection point must be a female-to-male or male-to-female connection (all daisy chain power units feature male ends).

MODEL	DESCRIPTION	LIST												
PB3-DC-S, Silver Finish PB3-DC-W, White Finish 	Power Band 3 Daisy Chain <ul style="list-style-type: none"> ■ Dimensions: 6.5" W x 2.5" D ■ Two (2) simplex outlets and two (2) USB charging ports. ■ UL listed. 	615												
PB-ST-CD-72 	Power Band Starter Cable, 72" Long, Corded Plug Infeed <ul style="list-style-type: none"> ■ Must select either corded or hardwire starter cable, which goes from power source in wall or floor to first Power Band Unit. 	255												
PB-ST-HW-() 	Power Band Starter Cable, Hardwire Infeed <ul style="list-style-type: none"> ■ Must select either corded or hardwire starter cable, which goes from power source in wall or floor to first Power Band Unit. <table border="1"> <thead> <tr> <th>MODEL</th> <th>LENGTH</th> <th>LIST</th> </tr> </thead> <tbody> <tr> <td>PB-ST-HW-72</td> <td>72"</td> <td>175</td> </tr> <tr> <td>PB-ST-HW-108</td> <td>108"</td> <td>205</td> </tr> <tr> <td>PB-ST-HW-120</td> <td>120"</td> <td>225</td> </tr> </tbody> </table>	MODEL	LENGTH	LIST	PB-ST-HW-72	72"	175	PB-ST-HW-108	108"	205	PB-ST-HW-120	120"	225	see table
MODEL	LENGTH	LIST												
PB-ST-HW-72	72"	175												
PB-ST-HW-108	108"	205												
PB-ST-HW-120	120"	225												

STRING GAMES MEETING TABLES - DAISY CHAIN COMPONENTS | Designed by Madsen & Contois

- Daisy chain units are required when more than one electrical unit is specified on one top.
- To determine jumper cable length, measure length from edge of electrical unit to end of table.
- Every connection point must be a female-to-male or male-to-female connection (all daisy chain power units feature male ends).

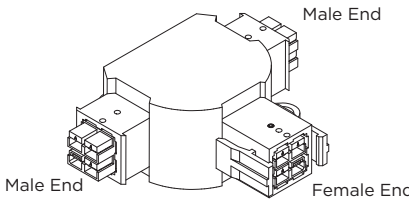
MODEL	DESCRIPTION	LIST																											
<p>PB3-FF-()</p> 	<p>Power Band Jumper Cables, Female to Female</p> <ul style="list-style-type: none"> ■ Typically used to connect two (2) units together. ■ For additional lengths in 12" increments, please add \$25 List per foot. <table border="1"> <thead> <tr> <th>MODEL</th> <th>LENGTH</th> <th>LIST</th> </tr> </thead> <tbody> <tr> <td>PB-FF-12</td> <td>12"</td> <td>120</td> </tr> <tr> <td>PB-FF-24</td> <td>24"</td> <td>130</td> </tr> <tr> <td>PB-FF-30</td> <td>30"</td> <td>145</td> </tr> <tr> <td>PB-FF-36</td> <td>36"</td> <td>145</td> </tr> <tr> <td>PB-FF-48</td> <td>48"</td> <td>155</td> </tr> <tr> <td>PB-FF-54</td> <td>54"</td> <td>160</td> </tr> <tr> <td>PB-FF-60</td> <td>60"</td> <td>165</td> </tr> <tr> <td>PB-FF-72</td> <td>72"</td> <td>175</td> </tr> </tbody> </table>	MODEL	LENGTH	LIST	PB-FF-12	12"	120	PB-FF-24	24"	130	PB-FF-30	30"	145	PB-FF-36	36"	145	PB-FF-48	48"	155	PB-FF-54	54"	160	PB-FF-60	60"	165	PB-FF-72	72"	175	see table
MODEL	LENGTH	LIST																											
PB-FF-12	12"	120																											
PB-FF-24	24"	130																											
PB-FF-30	30"	145																											
PB-FF-36	36"	145																											
PB-FF-48	48"	155																											
PB-FF-54	54"	160																											
PB-FF-60	60"	165																											
PB-FF-72	72"	175																											
<p>PB-FM-()</p> 	<p>Power Band Jumper Cables, Female to Male</p> <ul style="list-style-type: none"> ■ Typically used to connect two (2) units together. ■ For additional lengths in 12" increments, please add \$25 List per foot. <table border="1"> <thead> <tr> <th>MODEL</th> <th>LENGTH</th> <th>LIST</th> </tr> </thead> <tbody> <tr> <td>PB-FM-12</td> <td>12"</td> <td>120</td> </tr> <tr> <td>PB-FM-24</td> <td>24"</td> <td>130</td> </tr> <tr> <td>PB-FM-30</td> <td>30"</td> <td>145</td> </tr> <tr> <td>PB-FM-36</td> <td>36"</td> <td>145</td> </tr> <tr> <td>PB-FM-48</td> <td>48"</td> <td>155</td> </tr> <tr> <td>PB-FM-54</td> <td>54"</td> <td>160</td> </tr> <tr> <td>PB-FM-60</td> <td>60"</td> <td>165</td> </tr> <tr> <td>PB-FM-72</td> <td>72"</td> <td>175</td> </tr> </tbody> </table>	MODEL	LENGTH	LIST	PB-FM-12	12"	120	PB-FM-24	24"	130	PB-FM-30	30"	145	PB-FM-36	36"	145	PB-FM-48	48"	155	PB-FM-54	54"	160	PB-FM-60	60"	165	PB-FM-72	72"	175	see table
MODEL	LENGTH	LIST																											
PB-FM-12	12"	120																											
PB-FM-24	24"	130																											
PB-FM-30	30"	145																											
PB-FM-36	36"	145																											
PB-FM-48	48"	155																											
PB-FM-54	54"	160																											
PB-FM-60	60"	165																											
PB-FM-72	72"	175																											
<p>PB-T</p> 	<p>Power Band T-Connector</p> <ul style="list-style-type: none"> ■ Used when power is needed to go in two directions. ■ Two (2) male ends and one (1) female end. 	160																											

All shipments for this series will be blanket-wrapped as standard. If cartoning is required, a 5% upcharge will be added to each product. Please contact client services for additional information.

STRING GAMES MEETING TABLES - POWER UNIT PLACEMENT | Designed by Madsen & Contois

Table Top Positioning

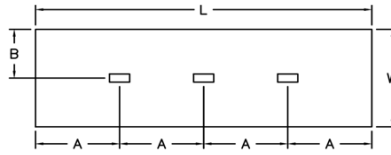
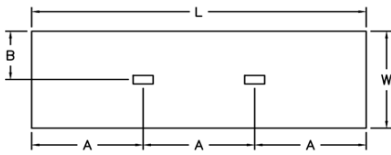

Panel Base (outside only, without exterior metal accent)

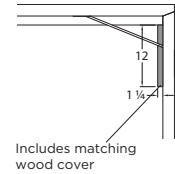
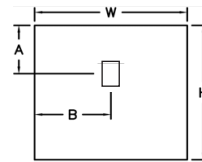

2 Power Units

W x L	A	B
24" x 60"	20"	12"
24" x 72"	24"	12"
24" x 84"	28"	12"
24" x 96"	32"	12"
30" x 60"	20"	15"
30" x 72"	24"	15"
30" x 84"	28"	15"
30" x 96"	32"	15"
36" x 60"	20"	18"
36" x 72"	24"	18"
36" x 84"	28"	18"
36" x 96"	32"	18"

3 Power Units

W x L	A	B
24" x 60"	15"	12"
24" x 72"	18"	12"
24" x 84"	21"	12"
24" x 96"	24"	12"
30" x 60"	15"	15"
30" x 72"	18"	15"
30" x 84"	21"	15"
30" x 96"	24"	15"
36" x 60"	15"	18"
36" x 72"	18"	18"
36" x 84"	21"	18"
36" x 96"	24"	18"

1 Power Unit

W x L	A	B
24" x 29"	8.75"	12"
30" x 29"	8.75"	15"
36" x 29"	8.75"	18"
24" x 42"	8.75"	12"
30" x 42"	8.75"	15"
36" x 42"	8.75"	18"

For custom power unit placement, please contact client services to verify that location can be accommodated.

All shipments for this series will be blanket-wrapped as standard. If cartoning is required, a 5% upcharge will be added to each product. Please contact client services for additional information.

SUITE BENCHES | Designed by David Dahl

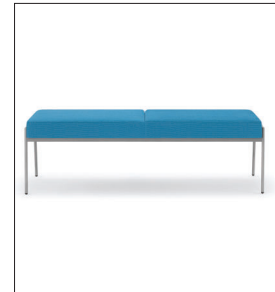

SPECIFICATIONS:

- Tubular steel frame available in three standard finish options. Please refer to listing below.
- For custom metal finish colors, please contact client services for pricing.
- 600 lb. weight capacity.
- All dimensions are nominal.
- Refer to terms and conditions for general information regarding fabrics, finishes, warranty, freight, complete condition of sales and more.

STANDARD FRAME FINISH COLORS:



- #06 Charcoal Grey
- #90 Metallic Silver
- #91 Chrome

All shipments for this series will be blanket-wrapped as standard. If cartoning is required, a 5% upcharge will be added to each product. Please contact client services for additional information.

SUITE BENCHES | Designed by David Dahl

ORDERING REQUIREMENTS:

- Model number
- Frame finish
- Upholstery selection
- Options, as applicable

MODEL	PRODUCT SPECIFICATIONS	FABRIC GRADES										LEATHER	
		COM	A	1	2	3	4	COL 5	6	7	8	L1	L2
7548 	48" Wide Bench 48" W x 22" D x 18" H COM: 2 yds. COL: 40 sq. ft. 38 lbs.	1,172	1,252	1,308	1,340	1,396	1,454	1,508	1,564	1,616	1,674	1,934	2,124
7560 	60" Wide Bench 60" W x 22" D x 18" H COM: 2 yds. COL: 40 sq. ft. 52 lbs.	1,399	1,479	1,535	1,567	1,623	1,681	1,735	1,791	1,843	1,901	2,161	2,351

OPTIONS

-VCT04	VCT Tile Glides	\$24
-MB02	Moisture Barrier	\$73

SUITE GUEST/TANDEM | Designed by David Dahl



PRODUCT FEATURES:



ARM CAPS:

- Field-replaceable arm caps available on all models.



PASSIVE-FLEX BACK:

- Featured on all models including bariatric chair.
- Passive-flex back motion provides long-term seated comfort.



CLEAN-OUT:

- Featured on all seating units, with the exception of models 7510 and 7515.
- Clean-out area between seat and back enables crumbs and other debris to fall through for maintenance ease.



METAL SEAT FRAME:

- Metal seat frame construction ensures durability and allows in-field component replacement as well as add-on capability for tandem units.



OPTIONAL REPLACEABLE UPHOLSTERY:

- Available on seats and backs of all models, including bariatric chair.
- Replacement seat and back covers can be easily field installed on previously ordered Suite models with standard fixed upholstery. Contact client services for instructions.

SUITE GUEST/TANDEM | Designed by David Dahl

PRODUCT FEATURES, CONTINUED:

- Wall-saver leg design.
- Three standard frame finish options. Refer to options below.
- All dimensions are nominal.
- Refer to terms and conditions for general information regarding fabrics, finishes, warranty, freight, complete condition of sales and more.

GUEST/TANDEM SEATING:

- Arm and armless guest models with open upholstered back.
- Bariatric models with arms also offered.
- Tandem models available in two and three-seat combinations or as reconfigurable modular units.
- Modular units offered with or without center arms.
- Three arm cap options: beech wood, black urethane or solid surface.
- Wood arm caps available in all standard finishes on beech. Please refer to standard finish card.
- For custom wood finishes, please add \$450 List per color per order.
- Solid surface arm caps available in white only.
- All standard finishes available on Beech.
- Tubular steel frame offered in three standard finishes. Refer to options below.
- Guest models feature 350 lb. weight capacity.
- Bariatric models feature 500 lb. weight capacity.
- VCT tile glides available for hard surface floors. Refer to individual pages for pricing.
- Please note that guest models do not feature clean-out area between seat and back.
- Include layout drawings or sketch with each tandem order.

CONNECTING TABLES:

- Three standard inline table options: 15" wide, 22" wide and 90-degree.
- End table offered in 22" width only.
- Wood veneer, laminate and solid surface top surface options.
- Wood top available in all standard finishes on beech. Please refer to standard finish card.
- For custom wood finishes, please contact client services and add one-time upcharge of \$450 List per color per order.
- For custom laminate options, add \$550 List per color per order. Pre-approval required, please contact client services.
- Solid surface available in white only.
- Laminate tops are 3/4" thick. Solid surface tops are 1/2" thick over a 1/2" thick wood substrate.
- For all table widths, wood grain laminates will run parallel to width of table.
- Self edge standard. PVC edge also available on laminate tops only.
- Tables are field installed.
- Please include layout drawings or sketch with each tandem order.

STANDARD METAL FRAME FINISH COLORS:

- #06 Charcoal Grey
- #90 Metallic Silver
- #91 Chrome

PVC EDGE COLORS:





- White
- Slate Grey
- Black

All shipments for this series will be blanket-wrapped as standard. If cartoning is required, a 5% upcharge will be added to each product. Please contact client services for additional information.

SUITE GUEST/TANDEM | Designed by David Dahl

ORDERING REQUIREMENTS:

- Model number
- Arm cap finish, as applicable
- Frame finish
- Upholstery selection
- Options, as applicable

MODEL	PRODUCT SPECIFICATIONS	FABRIC GRADES										LEATHER	
		COM	A	1	2	3	4	COL 5	6	7	8	L1	L2
7510 	Guest Chair, Armless 21" W x 25.5" D x 31.75" H Seat: 19" W x 18.5" D Seat Ht: 18" COM: 1.5 yds. COL: 30 sq. ft. 25 lbs.	1,090	1,150	1,192	1,216	1,258	1,302	1,342	1,384	1,423	1,467	1,662	1,804
7515-U 	Guest Chair, Black Urethane Arm Caps 21.75" W x 25.5" D x 31.75" H Seat: 19" W x 18.5" D Seat Ht: 18" Arm Ht: 25.75" COM: 1.5 yds. COL: 30 sq. ft. 26 lbs.	1,142	1,202	1,244	1,268	1,310	1,354	1,394	1,436	1,475	1,519	1,714	1,856
7515-W 	Guest Chair, Wood Arm Caps 21.75" W x 25.5" D x 31.75" H Seat: 19" W x 18.5" D Seat Ht: 18" Arm Ht: 25.75" COM: 1.5 yds. COL: 30 sq. ft. 26 lbs.	1,142	1,202	1,244	1,268	1,310	1,354	1,394	1,436	1,475	1,519	1,714	1,856
7515-SF 	Guest Chair, Solid Surface Arm Caps 21.75" W x 25.5" D x 31.75" H Seat: 19" W x 18.5" D Seat Ht: 18" Arm Ht: 25.75" COM: 1.5 yds. COL: 30 sq. ft. 26 lbs.	1,352	1,412	1,454	1,478	1,520	1,564	1,604	1,646	1,685	1,729	1,924	2,066





OPTIONS

-SC01	Replaceable Seat Cover (per seat)	\$47	-MB01	Moisture Barrier (seat only)	\$52
-BC01	Replaceable Back Cover (per back)	\$47	-VCT04	VCT Tile Glides	\$24

SUITE GUEST/TANDEM | Designed by David Dahl

ORDERING GUIDELINES:

- To build tandem configurations, always specify units from left-to-right as facing.
- Starter units ("-ST") represent the first seating model in a configuration with subsequent modular units building onto them towards the right.
- Add-on units ("-AO") can only be added next to starter units or other add-on units.
- End-units ("-EU") represent the final seating model in a configuration.
- Center and corner tables are for in-line placement only (cannot start or end a configuration) and for specification purposes, will always come before a starter unit, after an end unit or before/after a single chair (i.e. add-on units cannot be specified next to connecting tables).
- End tables can only start or end a configuration, therefore they will always come before a starter unit or after an end unit (i.e. add-on units cannot be specified next to connecting tables).

MODEL	PRODUCT SPECIFICATIONS	FABRIC GRADES										LEATHER	
		COM	A	1	2	3	4	COL 5	6	7	8	L1	L2
7511 	Single Chair, Armless 21" W x 25.5" D x 31.75" H Seat: 19" W x 18.5" D Seat Ht: 18" COM: 1.5 yds. COL: 30 sq. ft. 25 lbs.	1,138	1,198	1,240	1,264	1,306	1,350	1,390	1,432	1,471	1,515	1,710	1,852
7521-U 	Single Chair, Black Urethane Arm Caps 21.75" W x 25.5" D x 31.75" H Seat: 19" W x 18.5" D Seat Ht: 18" Arm Ht: 25.75" COM: 1.5 yds. COL: 30 sq. ft. 26 lbs.	1,190	1,250	1,292	1,316	1,358	1,402	1,442	1,484	1,523	1,567	1,762	1,904
7521-W 	Single Chair, Wood Arm Caps 21.75" W x 25.5" D x 31.75" H Seat: 19" W x 18.5" D Seat Ht: 18" Arm Ht: 25.75" COM: 1.5 yds. COL: 30 sq. ft. 26 lbs.	1,190	1,250	1,292	1,316	1,358	1,402	1,442	1,484	1,523	1,567	1,762	1,904
7521-SF 	Single Chair, Solid Surface Caps 21.75" W x 25.5" D x 31.75" H Seat: 19" W x 18.5" D Seat Ht: 18" Arm Ht: 25.75" COM: 1.5 yds. COL: 30 sq. ft. 26 lbs.	1,400	1,460	1,502	1,526	1,568	1,612	1,652	1,694	1,733	1,777	1,972	2,114

OPTIONS



-SC01	Replaceable Seat Cover (per seat)	\$47	-MB01	Moisture Barrier (seat only)	\$52
-BC01	Replaceable Back Cover (per back)	\$47	-VCT04	VCT Tile Glides	\$24

All shipments for this series will be blanket-wrapped as standard. If cartoning is required, a 5% upcharge will be added to each product. Please contact client services for additional information.

SUITE GUEST/TANDEM | Designed by David Dahl

ORDERING REQUIREMENTS:

- Model number
- Arm cap finish, as applicable
- Frame finish
- Upholstery selection
- Options, as applicable

MODEL	PRODUCT SPECIFICATIONS	FABRIC GRADES										LEATHER	
		COM	A	1	2	3	4	COL 5	6	7	8	L1	L2
7522-U	 <p>Tandem Two-Seater, Black Urethane Arm Caps 42" W x 25.5" D x 31.75" H Seat: 19" W x 18.5" D Seat Ht: 18" Arm Ht: 25.75" COM: 3 yds. COL: 60 sq. ft. 48 lbs.</p>	2,160	2,280	2,364	2,412	2,496	2,583	2,664	2,748	2,826	2,913	3,303	3,588
7522-W	 <p>Tandem Two-Seater, Wood Arm Caps 42" W x 25.5" D x 31.75" H Seat: 19" W x 18.5" D Seat Ht: 18" Arm Ht: 25.75" COM: 3 yds. COL: 60 sq. ft. 48 lbs.</p>	2,160	2,280	2,364	2,412	2,496	2,583	2,664	2,748	2,826	2,913	3,303	3,588
7522-SF	 <p>Tandem Two-Seater, Solid Surface Arm Caps 42" W x 25.5" D x 31.75" H Seat: 19" W x 18.5" D Seat Ht: 18" Arm Ht: 25.75" COM: 3 yds. COL: 60 sq. ft. 48 lbs.</p>	2,370	2,490	2,574	2,622	2,706	2,793	2,874	2,958	3,036	3,123	3,513	3,798

OPTIONS

-SC03	Replaceable Seat Cover (per two-seat unit)	\$100
-BC03	Replaceable Back Cover (per two-seat unit)	\$100
-MB04	Moisture Barrier (seat only, per two-seat unit)	\$100
-VCT06	VCT Tile Glides	\$36

All shipments for this series will be blanket-wrapped as standard. If cartoning is required, a 5% upcharge will be added to each product. Please contact client services for additional information.

SUITE GUEST/TANDEM | Designed by David Dahl

ORDERING REQUIREMENTS:

- Model number
- Arm cap finish, as applicable
- Frame finish
- Upholstery selection
- Options, as applicable

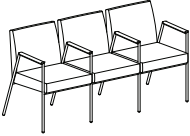
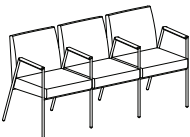
MODEL	PRODUCT SPECIFICATIONS	FABRIC GRADES										LEATHER	
		COM	A	1	2	3	4	COL 5	6	7	8	L1	L2
7523-U	 <p>Tandem Three-Seater, Black Urethane Arm Caps 62" W x 25.5" D x 31.75" H Seat: 19" W x 18.5" D Seat Ht: 18" Arm Ht: 25.75" COM: 4.5 yds. COL: 90 sq. ft. 70 lbs.</p>	3,185	3,365	3,491	3,563	3,689	3,820	3,941	4,067	4,184	4,315	4,900	5,327
7523-W	 <p>Tandem Three-Seater, Wood Arm Caps 62" W x 25.5" D x 31.75" H Seat: 19" W x 18.5" D Seat Ht: 18" Arm Ht: 25.75" COM: 4.5 yds. COL: 90 sq. ft. 70 lbs.</p>	3,185	3,365	3,491	3,563	3,689	3,820	3,941	4,067	4,184	4,315	4,900	5,327
7523-SF	 <p>Tandem Three-Seater, Solid Surface Arm Caps 62" W x 25.5" D x 31.75" H Seat: 19" W x 18.5" D Seat Ht: 18" Arm Ht: 25.75" COM: 4.5 yds. COL: 90 sq. ft. 70 lbs.</p>	3,395	3,575	3,701	3,773	3,899	4,030	4,151	4,277	4,394	4,525	5,110	5,537

OPTIONS

-SC04	Replaceable Seat Cover (per three-seat unit)	\$150
-BC04	Replaceable Back Cover (per three-seat unit)	\$150
-MB05	Moisture Barrier (seat only, per three-seat unit)	\$150
-VCT08	VCT Tile Glides	\$46

SUITE GUEST/TANDEM | Designed by David Dahl

ORDERING GUIDELINES:

- To build tandem configurations, always specify units from left-to-right as facing.
- Starter units ("-ST") represent the first seating model in a configuration with subsequent modular units building onto them towards the right.
- Add-on units ("-AO") can only be added next to starter units or other add-on units.
- End-units ("-EU") represent the final seating model in a configuration.
- Center and corner tables are for in-line placement only (cannot start or end a configuration) and for specification purposes, will always come before a starter unit, after an end unit or before/after a single chair (i.e. add-on units cannot be specified next to connecting tables).
- End tables can only start or end a configuration, therefore they will always come before a starter unit or after an end unit (i.e. add-on units cannot be specified next to connecting tables).

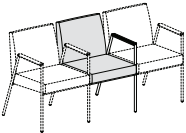
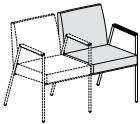
MODEL	PRODUCT SPECIFICATIONS	FABRIC GRADES										LEATHER	
		COM	A	1	2	3	4	COL 5	6	7	8	L1	L2
7520-ST-U	 <p>Tandem Starter Unit, Black Urethane Arm Caps 21.75" W x 25.5" D x 31.75" H Seat: 19" W x 18.5" D Seat Ht: 18" Arm Ht: 25.75" COM: 1.5 yds. COL: 30 sq. ft. 26 lbs.</p>	1,187	1,247	1,289	1,313	1,355	1,399	1,439	1,481	1,520	1,564	1,759	1,901
7520-AO-U	 <p>Tandem Add-On Unit, Black Urethane Arm Cap 20" W x 25.5" D x 31.75" H Seat: 19" W x 18.5" D Seat Ht: 18" Arm Ht: 25.75" COM: 1.5 yds. COL: 30 sq. ft. 22 lbs.</p>	1,064	1,124	1,166	1,190	1,232	1,276	1,316	1,358	1,397	1,441	1,636	1,778
7520-EU-U	 <p>Tandem End Unit, Black Urethane Arm Cap 20" W x 25.5" D x 31.75" H Seat: 19" W x 18.5" D Seat Ht: 18" Arm Ht: 25.75" COM: 1.5 yds. COL: 30 sq. ft. 22 lbs.</p>	1,049	1,109	1,151	1,175	1,217	1,261	1,301	1,343	1,382	1,426	1,621	1,763

OPTIONS

-SC01	Replaceable Seat Cover (per seat)	\$47	-VCT04	VCT Tile Glides (starter unit)	\$24
-BC01	Replaceable Back Cover (per back)	\$47	-VCT02	VCT Tile Glides (add-on and end units)	\$12
-MB01	Moisture Barrier (seat only, per unit)	\$52			

All shipments for this series will be blanket-wrapped as standard. If cartoning is required, a 5% upcharge will be added to each product. Please contact client services for additional information.

SUITE GUEST/TANDEM | Designed by David Dahl

ORDERING GUIDELINES:

- To build tandem configurations, always specify units from left-to-right as facing.
- Starter units ("-ST") represent the first seating model in a configuration with subsequent modular units building onto them towards the right.
- Add-on units ("-AO") can only be added next to starter units or other add-on units.
- End-units ("-EU") represent the final seating model in a configuration.
- Center and corner tables are for in-line placement only (cannot start or end a configuration) and for specification purposes, will always come before a starter unit, after an end unit or before/after a single chair (i.e. add-on units cannot be specified next to connecting tables).
- End tables can only start or end a configuration, therefore they will always come before a starter unit or after an end unit (i.e. add-on units cannot be specified next to connecting tables).

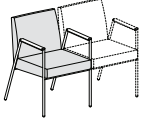
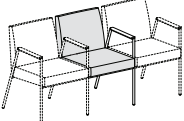
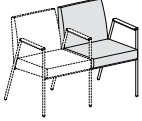
MODEL	PRODUCT SPECIFICATIONS	FABRIC GRADES								LEATHER			
		COM	A	1	2	3	4	COL 5	6	7	8	L1	L2
7520-ST-W 	Tandem Starter Unit, Wood Arm Caps 21.75" W x 25.5" D x 31.75" H Seat: 19" W x 18.5" D Seat Ht: 18" Arm Ht: 25.75" COM: 1.5 yds. COL: 30 sq. ft. 26 lbs.	1,187	1,247	1,289	1,313	1,355	1,399	1,439	1,481	1,520	1,564	1,759	1,901
7520-AO-W 	Tandem Add-On Unit, Wood Arm Cap 20" W x 25.5" D x 31.75" H Seat: 19" W x 18.5" D Seat Ht: 18" Arm Ht: 25.75" COM: 1.5 yds. COL: 30 sq. ft. 22 lbs.	1,064	1,124	1,166	1,190	1,232	1,276	1,316	1,358	1,397	1,441	1,636	1,778
7520-EU-W 	Tandem End Unit, Wood Arm Cap 20" W x 25.5" D x 31.75" H Seat: 19" W x 18.5" D Seat Ht: 18" Arm Ht: 25.75" COM: 1.5 yds. COL: 30 sq. ft. 22 lbs.	1,049	1,109	1,151	1,175	1,217	1,261	1,301	1,343	1,382	1,426	1,621	1,763

OPTIONS

-SCO1	Replaceable Seat Cover (per seat)	\$47	-VCT04	VCT Tile Glides (starter unit)	\$24
-BC01	Replaceable Back Cover (per back)	\$47	-VCT02	VCT Tile Glides (add-on and end units)	\$12
-MB01	Moisture Barrier (seat only, per unit)	\$52			

SUITE GUEST/TANDEM | Designed by David Dahl

ORDERING GUIDELINES:

- To build tandem configurations, always specify units from left-to-right as facing.
- Starter units ("-ST") represent the first seating model in a configuration with subsequent modular units building onto them towards the right.
- Add-on units ("-AO") can only be added next to starter units or other add-on units.
- End-units ("-EU") represent the final seating model in a configuration.
- Center and corner tables are for in-line placement only (cannot start or end a configuration) and for specification purposes, will always come before a starter unit, after an end unit or before/after a single chair (i.e. add-on units cannot be specified next to connecting tables).
- End tables can only start or end a configuration, therefore they will always come before a starter unit or after an end unit (i.e. add-on units cannot be specified next to connecting tables).

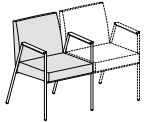
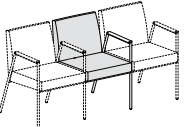
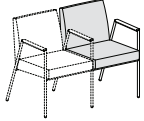
MODEL	PRODUCT SPECIFICATIONS	FABRIC GRADES								LEATHER			
		COM	A	1	2	3	4	COL 5	6	7	8	L1	L2
7520-ST-SF 	Tandem Starter Unit, Solid Surface Arm Caps 21.75" W x 25.5" D x 31.75" H Seat: 19" W x 18.5" D Seat Ht: 18" Arm Ht: 25.75" COM: 1.5 yds. COL: 30 sq. ft. 26 lbs.	1,397	1,457	1,499	1,523	1,565	1,609	1,649	1,691	1,730	1,774	1,969	2,111
7520-AO-SF 	Tandem Add-On Unit, Solid Surface Arm Cap 20" W x 25.5" D x 31.75" H Seat: 19" W x 18.5" D Seat Ht: 18" Arm Ht: 25.75" COM: 1.5 yds. COL: 30 sq. ft. 22 lbs.	1,169	1,229	1,271	1,295	1,337	1,381	1,421	1,463	1,502	1,546	1,741	1,883
7520-EU-SF 	Tandem End Unit, Solid Surface Arm Cap 20" W x 25.5" D x 31.75" H Seat: 19" W x 18.5" D Seat Ht: 18" Arm Ht: 25.75" COM: 1.5 yds. COL: 30 sq. ft. 22 lbs.	1,154	1,214	1,256	1,280	1,322	1,366	1,406	1,448	1,487	1,531	1,726	1,868

OPTIONS



-SC01	Replaceable Seat Cover (per seat)	\$47	-VCT04	VCT Tile Glides (starter unit)	\$24
-BC01	Replaceable Back Cover (per back)	\$47	-VCT02	VCT Tile Glides (add-on and end units)	\$12
-MB01	Moisture Barrier (seat only, per unit)	\$52			

All shipments for this series will be blanket-wrapped as standard. If cartoning is required, a 5% upcharge will be added to each product. Please contact client services for additional information.

SUITE GUEST/TANDEM | Designed by David Dahl

ORDERING GUIDELINES:

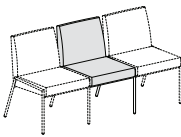
- To build tandem configurations, always specify units from left-to-right as facing.
- Starter units ("-ST") represent the first seating model in a configuration with subsequent modular units building onto them towards the right.
- Add-on units ("-AO") can only be added next to starter units or other add-on units.
- End-units ("-EU") represent the final seating model in a configuration.
- Center and corner tables are for in-line placement only (cannot start or end a configuration) and for specification purposes, will always come before a starter unit, after an end unit or before/after a single chair (i.e. add-on units cannot be specified next to connecting tables).
- End tables can only start or end a configuration, therefore they will always come before a starter unit or after an end unit (i.e. add-on units cannot be specified next to connecting tables).

MODEL	PRODUCT SPECIFICATIONS	FABRIC GRADES								LEATHER			
		COM	A	1	2	3	4	COL 5	6	7	8	L1	L2
7530-ST 	Tandem Starter Unit, Armless 21" W x 25.5" D x 31.75" H Seat: 19" W x 18.5" D Seat Ht: 18" COM: 1.5 yds. COL: 30 sq. ft. 25 lbs.	1,054	1,114	1,156	1,180	1,222	1,266	1,306	1,348	1,387	1,431	1,626	1,768
7530-AO 	Tandem Add-On Unit, Armless 20.25" W x 25.5" D x 31.75" H Seat: 19" W x 18.5" D Seat Ht: 18" COM: 1.5 yds. COL: 30 sq. ft. 21 lbs.	1,004	1,064	1,106	1,130	1,172	1,216	1,256	1,298	1,337	1,381	1,576	1,718
7530-EU 	Tandem End Unit, Armless 20.25" W x 25.5" D x 31.75" H Seat: 19" W x 18.5" D Seat Ht: 18" COM: 1.5 yds. COL: 30 sq. ft. 21 lbs.	992	1,052	1,094	1,118	1,160	1,204	1,244	1,286	1,325	1,369	1,564	1,706



OPTIONS

-SC01	Replaceable Seat Cover (per seat)	\$47	-VCT04	VCT Tile Glides (starter unit)	\$24
-BC01	Replaceable Back Cover (per back)	\$47	-VCT02	VCT Tile Glides (add-on and end units)	\$12
-MB01	Moisture Barrier (seat only, per unit)	\$52			

SUITE GUEST/TANDEM | Designed by David Dahl

ORDERING GUIDELINES:

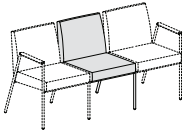
- To build tandem configurations, always specify units from left-to-right as facing.
- Starter units ("-ST") represent the first seating model in a configuration with subsequent modular units building onto them towards the right.
- Add-on units ("-AO") can only be added next to starter units or other add-on units.
- End-units ("-EU") represent the final seating model in a configuration.
- Center and corner tables are for in-line placement only (cannot start or end a configuration) and for specification purposes, will always come before a starter unit, after an end unit or before/after a single chair (i.e. add-on units cannot be specified next to connecting tables).
- End tables can only start or end a configuration, therefore they will always come before a starter unit or after an end unit (i.e. add-on units cannot be specified next to connecting tables).

MODEL	PRODUCT SPECIFICATIONS	FABRIC GRADES								LEATHER			
		COM	A	1	2	3	4	COL 5	6	7	8	L1	L2
7535-ST-U 	Tandem Starter Unit, Black Urethane Arm Cap, Armless 21.5" W x 25.5" D x 31.75" H Seat: 19" W x 18.5" D Seat Ht: 18" Arm Ht: 25.75" COM: 1.5 yds. COL: 30 sq. ft. 25 lbs.	1,118	1,178	1,220	1,244	1,286	1,330	1,370	1,412	1,451	1,495	1,690	1,832
7530-AO 	Tandem Add-On Unit, Armless 20.25" W x 25.5" D x 31.75" H Seat: 19" W x 18.5" D Seat Ht: 18" COM: 1.5 yds. COL: 30 sq. ft. 21 lbs.	1,004	1,064	1,106	1,130	1,172	1,216	1,256	1,298	1,337	1,381	1,576	1,718
7535-EU-U 	Tandem End Unit, Armless, Black Urethane Arm Cap 21.5" W x 25.5" D x 31.75" H Seat: 19" W x 18.5" D Seat Ht: 18" Arm Ht: 25.75" COM: 1.5 yds. COL: 30 sq. ft. 25 lbs.	1,048	1,108	1,150	1,174	1,216	1,260	1,300	1,342	1,381	1,425	1,620	1,762

OPTIONS

-SCO1	Replaceable Seat Cover (per seat)	\$47	-VCT04	VCT Tile Glides (starter unit)	\$24
-BC01	Replaceable Back Cover (per back)	\$47	-VCT02	VCT Tile Glides (add-on and end units)	\$12
-MB01	Moisture Barrier (seat only, per unit)	\$52			

SUITE GUEST/TANDEM | Designed by David Dahl

ORDERING GUIDELINES:

- To build tandem configurations, always specify units from left-to-right as facing.
- Starter units ("-ST") represent the first seating model in a configuration with subsequent modular units building onto them towards the right.
- Add-on units ("-AO") can only be added next to starter units or other add-on units.
- End-units ("-EU") represent the final seating model in a configuration.
- Center and corner tables are for in-line placement only (cannot start or end a configuration) and for specification purposes, will always come before a starter unit, after an end unit or before/after a single chair (i.e. add-on units cannot be specified next to connecting tables).
- End tables can only start or end a configuration, therefore they will always come before a starter unit or after an end unit (i.e. add-on units cannot be specified next to connecting tables).

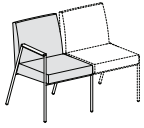
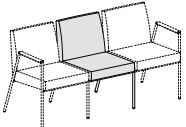
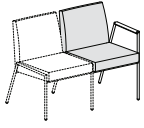
MODEL	PRODUCT SPECIFICATIONS	FABRIC GRADES								LEATHER			
		COM	A	1	2	3	4	COL 5	6	7	8	L1	L2
7535-ST-W 	Tandem Starter Unit, Wood Arm Cap, Armless 21.5" W x 25.5" D x 31.75" H Seat: 19" W x 18.5" D Seat Ht: 18" Arm Ht: 25.75" COM: 1.5 yds. COL: 30 sq. ft. 25 lbs.	1,118	1,178	1,220	1,244	1,286	1,330	1,370	1,412	1,451	1,495	1,690	1,832
7530-AO 	Tandem Add-On Unit, Armless 20.25" W x 25.5" D x 31.75" H Seat: 19" W x 18.5" D Seat Ht: 18" COM: 1.5 yds. COL: 30 sq. ft. 21 lbs.	1,004	1,064	1,106	1,130	1,172	1,216	1,256	1,298	1,337	1,381	1,576	1,718
7535-EU-W 	Tandem End Unit, Armless, Wood Arm Cap 21.5" W x 25.5" D x 31.75" H Seat: 19" W x 18.5" D Seat Ht: 18" Arm Ht: 25.75" COM: 1.5 yds. COL: 30 sq. ft. 25 lbs.	1,048	1,108	1,150	1,174	1,216	1,260	1,300	1,342	1,381	1,425	1,620	1,762

OPTIONS



-SCO1	Replaceable Seat Cover (per seat)	\$47	-VCT04	VCT Tile Glides (starter unit)	\$24
-BC01	Replaceable Back Cover (per back)	\$47	-VCT02	VCT Tile Glides (add-on unit)	\$12
-MB01	Moisture Barrier (seat only, per unit)	\$52			

All shipments for this series will be blanket-wrapped as standard. If cartoning is required, a 5% upcharge will be added to each product. Please contact client services for additional information.

SUITE GUEST/TANDEM | Designed by David Dahl

ORDERING GUIDELINES:

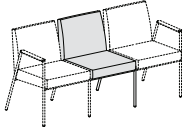
- To build tandem configurations, always specify units from left-to-right as facing.
- Starter units ("-ST") represent the first seating model in a configuration with subsequent modular units building onto them towards the right.
- Add-on units ("-AO") can only be added next to starter units or other add-on units.
- End-units ("-EU") represent the final seating model in a configuration.
- Center and corner tables are for in-line placement only (cannot start or end a configuration) and for specification purposes, will always come before a starter unit, after an end unit or before/after a single chair (i.e. add-on units cannot be specified next to connecting tables).
- End tables can only start or end a configuration, therefore they will always come before a starter unit or after an end unit (i.e. add-on units cannot be specified next to connecting tables).

MODEL	PRODUCT SPECIFICATIONS	FABRIC GRADES								LEATHER			
		COM	A	1	2	3	4	COL 5	6	7	8	L1	L2
7535-ST-SF 	Tandem Starter Unit, Solid Surface Arm Cap, Armless 21.5" W x 25.5" D x 31.75" H Seat: 19" W x 18.5" D Seat Ht: 18" Arm Ht: 25.75" COM: 1.5 yds. COL: 30 sq. ft. 25 lbs.	1,223	1,283	1,325	1,349	1,391	1,435	1,475	1,517	1,556	1,600	1,795	1,937
7530-AO 	Tandem Add-On Unit, Armless 20.25" W x 25.5" D x 31.75" H Seat: 19" W x 18.5" D Seat Ht: 18" COM: 1.5 yds. COL: 30 sq. ft. 21 lbs.	1,004	1,064	1,106	1,130	1,172	1,216	1,256	1,298	1,337	1,381	1,576	1,718
7535-EU-SF 	Tandem End Unit, Armless, Solid Surface Arm Cap 21.5" W x 25.25" D x 31.75" H Seat: 19" W x 18.5" D Seat Ht: 18" Arm Ht: 25.75" COM: 1.5 yds. COL: 30 sq. ft. 25 lbs.	1,153	1,213	1,255	1,279	1,321	1,365	1,405	1,447	1,486	1,530	1,725	1,867

OPTIONS



-SCO1	Replaceable Seat Cover (per seat)	\$47	-VCT04	VCT Tile Glides (starter unit)	\$24
-BC01	Replaceable Back Cover (per back)	\$47	-VCT02	VCT Tile Glides (add-on and end units)	\$12
-MB01	Moisture Barrier (seat only, per unit)	\$52			

All shipments for this series will be blanket-wrapped as standard. If cartoning is required, a 5% upcharge will be added to each product. Please contact client services for additional information.

SUITE GUEST/TANDEM | Designed by David Dahl

ORDERING REQUIREMENTS:

- Model number
- Arm cap finish, as applicable
- Frame finish
- Upholstery selection
- Options, as applicable

MODEL	PRODUCT SPECIFICATIONS	FABRIC GRADES										LEATHER	
		COM	A	1	2	3	4	COL 5	6	7	8	L1	L2
7550-U	 <p>Single Bariatric Chair, Black Urethane Arm Caps 31.75" W x 25.5" D x 31.75" H Seat: 29" W x 19" D Seat Ht: 18" Arm Ht: 25.75" COM: 2 yds. COL: 40 sq. ft. 33 lbs.</p>	1,430	1,510	1,566	1,598	1,654	1,712	1,766	1,822	1,874	1,932	2,192	2,382
7550-W	 <p>Single Bariatric Chair, Wood Arm Caps 31.75" W x 25.5" D x 31.75" H Seat: 29" W x 19" D Seat Ht: 18" Arm Ht: 25" COM: 2 yds. COL: 40 sq. ft. 33 lbs.</p>	1,430	1,510	1,566	1,598	1,654	1,712	1,766	1,822	1,874	1,932	2,192	2,382
7550-SF	 <p>Single Bariatric Chair, Solid Surface Arm Caps 31.75" W x 25.5" D x 31.75" H Seat: 29" W x 19" D Seat Ht: 18" Arm Ht: 25.75" COM: 2 yds. COL: 40 sq. ft. 33 lbs.</p>	1,640	1,720	1,776	1,808	1,864	1,922	1,976	2,032	2,084	2,142	2,402	2,592

OPTIONS



-SCO2	Replaceable Seat Cover (per seat)	\$57	-VCT04	VCT Tile Glides	\$24
-BC02	Replaceable Back Cover (per back)	\$57			
-MB02	Moisture Barrier (seat only, per unit)	\$73			

All shipments for this series will be blanket-wrapped as standard. If cartoning is required, a 5% upcharge will be added to each product. Please contact client services for additional information.

SUITE GUEST/TANDEM | Designed by David Dahl

ORDERING GUIDELINES:

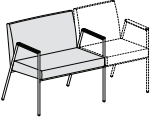
- To build tandem configurations, always specify units from left-to-right as facing.
- Starter units ("-ST") represent the first seating model in a configuration with subsequent modular units building onto them towards the right.
- Add-on units ("-AO") can only be added next to starter units or other add-on units.
- End-units ("-EU") represent the final seating model in a configuration.
- Center and corner tables are for in-line placement only (cannot start or end a configuration) and for specification purposes, will always come before a starter unit, after an end unit or before/after a single chair (i.e. add-on units cannot be specified next to connecting tables).
- End tables can only start or end a configuration, therefore they will always come before a starter unit or after an end unit (i.e. add-on units cannot be specified next to connecting tables).

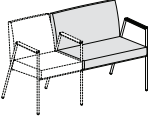
MODEL	PRODUCT SPECIFICATIONS	FABRIC GRADES										LEATHER	
		COM	A	1	2	3	4	COL 5	6	7	8	L1	L2
7550-ST-U 	Bariatric Starter Unit, Black Urethane Arm Caps 31.75" W x 25.5" D x 31.75" H Seat: 29" W x 19" D Seat Ht: 18" Arm Ht: 25.75" COM: 2 yds. COL: 40 sq. ft. 33 lbs.	1,423	1,503	1,559	1,591	1,647	1,705	1,759	1,815	1,867	1,925	2,185	2,375
7550-AO-U 	Bariatric Add-On Unit, Black Urethane Arm Cap 30.5" W x 25.5" D x 31.75" H Seat: 29" W x 19" D Seat Ht: 18" Arm Ht: 25.75" COM: 2 yds. COL: 40 sq. ft. 29 lbs.	1,307	1,387	1,443	1,475	1,531	1,589	1,643	1,699	1,751	1,809	2,069	2,259
7550-EU-U 	Bariatric End Unit, Black Urethane Arm Cap 30.5" W x 25.5" D x 31.75" H Seat: 29" W x 19" D Seat Ht: 18" Arm Ht: 25.75" COM: 2 yds. COL: 40 sq. ft. 29 lbs.	1,294	1,374	1,430	1,462	1,518	1,576	1,630	1,686	1,738	1,796	2,056	2,246

OPTIONS

-SC02	Replaceable Seat Cover (per seat)	\$57	-VCT04	VCT Tile Glides (starter unit)	\$24
-BC02	Replaceable Back Cover (per back)	\$57	-VCT02	VCT Tile Glides (add-on and end units)	\$12
-MB02	Moisture Barrier (seat only, per unit)	\$73			

SUITE GUEST/TANDEM | Designed by David Dahl

ORDERING GUIDELINES:

- To build tandem configurations, always specify units from left-to-right as facing.
- Starter units ("-ST") represent the first seating model in a configuration with subsequent modular units building onto them towards the right.
- Add-on units ("-AO") can only be added next to starter units or other add-on units.
- End-units ("-EU") represent the final seating model in a configuration.
- Center and corner tables are for in-line placement only (cannot start or end a configuration) and for specification purposes, will always come before a starter unit, after an end unit or before/after a single chair (i.e. add-on units cannot be specified next to connecting tables).
- End tables can only start or end a configuration, therefore they will always come before a starter unit or after an end unit (i.e. add-on units cannot be specified next to connecting tables).

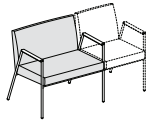
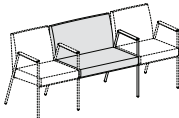
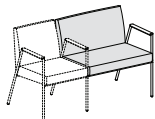
MODEL	PRODUCT SPECIFICATIONS	FABRIC GRADES								LEATHER			
		COM	A	1	2	3	4	COL 5	6	7	8	L1	L2
7550-ST-W 	Bariatric Starter Unit, Wood Arm Caps 31.75" W x 25.5" D x 31.75" H Seat: 29" W x 19" D Seat Ht: 18" Arm Ht: 25.75" COM: 2 yds. COL: 40 sq. ft. 33 lbs.	1,423	1,503	1,559	1,591	1,647	1,705	1,759	1,815	1,867	1,925	2,185	2,375
7550-AO-W 	Bariatric Add-On Unit, Wood Arm Cap 30.5" W x 25.5" D x 31.75" H Seat: 29" W x 19" D Seat Ht: 18" Arm Ht: 25.75" COM: 2 yds. COL: 40 sq. ft. 29 lbs.	1,307	1,387	1,443	1,475	1,531	1,589	1,643	1,699	1,751	1,809	2,069	2,259
7550-EU-W 	Bariatric End Unit Wood Arm Cap 30.5" W x 25.5" D x 31.75" H Seat: 29" W x 19" D Seat Ht: 18" Arm Ht: 25.75" COM: 2 yds. COL: 40 sq. ft. 29 lbs.	1,294	1,374	1,430	1,462	1,518	1,576	1,630	1,686	1,738	1,796	2,056	2,246

OPTIONS

-SCO2	Replaceable Seat Cover (per seat)	\$57	-VCT04	VCT Tile Glides (starter unit)	\$24
-BCO2	Replaceable Back Cover (per back)	\$57	-VCT02	VCT Tile Glides (add-on and end units)	\$12
-MB02	Moisture Barrier (seat only, per unit)	\$73			

SUITE GUEST/TANDEM | Designed by David Dahl

ORDERING GUIDELINES:

- To build tandem configurations, always specify units from left-to-right as facing.
- Starter units ("-ST") represent the first seating model in a configuration with subsequent modular units building onto them towards the right.
- Add-on units ("-AO") can only be added next to starter units or other add-on units.
- End-units ("-EU") represent the final seating model in a configuration.
- Center and corner tables are for in-line placement only (cannot start or end a configuration) and for specification purposes, will always come before a starter unit, after an end unit or before/after a single chair (i.e. add-on units cannot be specified next to connecting tables).
- End tables can only start or end a configuration, therefore they will always come before a starter unit or after an end unit (i.e. add-on units cannot be specified next to connecting tables).

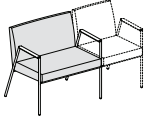
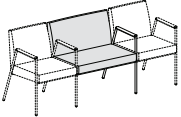
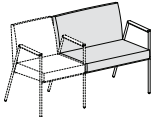
MODEL	PRODUCT SPECIFICATIONS	FABRIC GRADES								LEATHER			
		COM	A	1	2	3	4	COL 5	6	7	8	L1	L2
7550-ST-SF 	Bariatric Starter Unit, Solid Surface Arm Caps 31.75" W x 25.5" D x 31.75" H Seat: 29" W x 19" D Seat Ht: 18" Arm Ht: 25.75" COM: 2 yds. COL: 40 sq. ft. 33 lbs.	1,633	1,713	1,769	1,801	1,857	1,915	1,969	2,025	2,077	2,135	2,395	2,585
7550-AO-SF 	Bariatric Add-On Unit, Solid Surface Arm Cap 30.5" W x 25.5" D x 31.75" H Seat: 29" W x 19" D Seat Ht: 18" Arm Ht: 25.75" COM: 2 yds. COL: 40 sq. ft. 29 lbs.	1,412	1,492	1,548	1,580	1,636	1,694	1,748	1,804	1,856	1,914	2,174	2,364
7550-EU-SF 	Bariatric End Unit Solid Surface Arm Cap 30.5" W x 25.5" D x 31.75" H Seat: 29" W x 19" D Seat Ht: 18" Arm Ht: 25.75" COM: 2 yds. COL: 40 sq. ft. 29 lbs.	1,399	1,479	1,535	1,567	1,623	1,681	1,735	1,791	1,843	1,901	2,161	2,351

OPTIONS

-SC02	Replaceable Seat Cover (per seat)	\$57	-VCT04	VCT Tile Glides (starter unit)	\$24
-BC02	Replaceable Back Cover (per back)	\$57	-VCT02	VCT Tile Glides (add-on and end units)	\$12
-MB02	Moisture Barrier (seat only, per unit)	\$73			

All shipments for this series will be blanket-wrapped as standard. If cartoning is required, a 5% upcharge will be added to each product. Please contact client services for additional information.

SUITE GUEST/TANDEM | Designed by David Dahl

ORDERING REQUIREMENTS:

- Model number
- Top surface
- Top finish, as applicable
- Frame finish, as applicable
- Options, as applicable

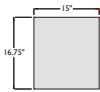
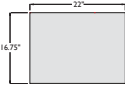
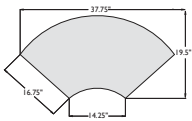
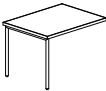
MODEL	PRODUCT SPECIFICATIONS	WOOD (-V) OR LAMINATE TOP (-L)	SOLID SURFACE TOP (-SF)	WEIGHT
7540-15-() 	15" Wide Center Table 15" W x 16.75" D	501	605	2
7540-22-() 	22" Wide Center Table 22" W x 16.75" D	569	721	3
7540-90-() 	90-Degree Corner Table 37.75" W x 19.5" D	614	958	6
7540-ET-() 	22" Wide End Table 22" W x 16.75" D	648	800	5

OPTIONS

-VCT02 VCT Tile Glides (end table) \$12

SUITE GUEST/TANDEM | Designed by David Dahl

TANDEM CONFIGURATIONS & ORDERING EXAMPLES:

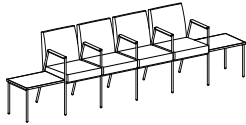

<u>Qty</u>	<u>Model #</u>	<u>Description</u>	<u>COM List</u>
2	7540-ET-W	22" Wide End Table, Wood Top (\$648 List each)	\$1,296
1	7520-ST-W	Tandem Starter Unit, Wood Arm Caps	\$1,187
2	7520-AO-W	Tandem Add-On Unit, Wood Arm Caps (\$1,064 List each)	\$2,128
1	7520-EU-W	Tandem End Unit, Wood Arm Caps	\$1,049
			\$5,660



<u>Qty</u>	<u>Model #</u>	<u>Description</u>	<u>COM List</u>
1	7522-U	Tandem Two-Seater, Black Urethane Arm Caps	\$2,160
1	7540-15-SF	15" Wide Inline Table, Solid Surface Top	\$605
1	7523-U	Tandem Three-Seater, Black Urethane Arm Caps	\$3,185
			\$5,950



<u>Qty</u>	<u>Model #</u>	<u>Description</u>	<u>COM List</u>
1	7550-ST-W	Bariatric Starter Unit, Wood Arm Caps	\$1,423
1	7520-AO-W	Tandem Add-On Unit, Wood Arm Caps	\$1,064
2	7520-EU-W	Tandem End Unit, Wood Arm Caps (\$1,049 List each)	\$2,098
1	7540-90-L	90-Degree Connecting Table, Laminate Top	\$614
1	7520-ST-W	Tandem Starter Unit, Wood Arm Caps	\$1,187
1	7550-AO-W	Bariatric Add-On Unit, Wood Arm Caps	\$1,307
			\$7,693

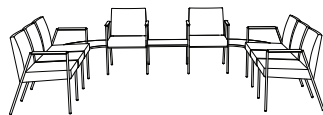

<u>Qty</u>	<u>Model #</u>	<u>Description</u>	<u>COM List</u>
2	7535-ST-W	Tandem Starter Unit, Wood Arm Cap/Armless (\$1,118 List each)	\$2,236
2	7530-AO	Tandem Add-On Unit, Armless (\$1,004 List each)	\$2,008
2	7535-EU-W	Tandem End Unit, Armless/Wood Arm Cap (\$1,048 List each)	\$2,096
2	7540-90-W	90-Degree Connecting Table, Wood Top (\$614 List each)	\$1,228
2	7521-W	Single Chair, Wood Arm Caps (\$1,190 List each)	\$2,380
1	7540-22-W	22" Wide Inline Table, Wood Top	\$569
			\$10,517

All shipments for this series will be blanket-wrapped as standard. If cartoning is required, a 5% upcharge will be added to each product. Please contact client services for additional information.

SUITE GUEST/TANDEM | Designed by David Dahl

PRODUCT FEATURES:

- Concealed velcro attachment.
- Replacement seat and back covers can be easily field installed on previously ordered Suite models with replaceable cover option.
- Suite models originally ordered with standard fixed upholstery can utilize replacement seat and/or back covers; however, some upholstery work will be required to remove original upholstery covers.









MODEL	PRODUCT SPECIFICATIONS	FABRIC GRADES										LEATHER	
		COM	A	1	2	3	4	COL 5	6	7	8	L1	L2
RSC-7515	Guest/Tandem Replacement Upholstered Seat Cover COM: .75 yd. COL: 15 sq. ft.	163	193	214	226	247	269	289	310	330	352	449	520
RBC-7515	Guest/Tandem Replacement Upholstered Back Cover COM: .75 yd. COL: 15 sq. ft.	163	193	214	226	247	269	289	310	330	352	449	520
RSC-7550	Bariatric Replacement Upholstered Seat Cover COM: 1 yd. COL: 20 sq. ft.	204	244	272	288	316	345	372	400	426	455	585	680
RBC-7550	Bariatric Replacement Upholstered Back Cover COM: 1 yd. COL: 20 sq. ft.	204	244	272	288	316	345	372	400	426	455	585	680

All shipments for this series will be blanket-wrapped as standard. If cartoning is required, a 5% upcharge will be added to each product. Please contact client services for additional information.

SUITE GUEST/TANDEM | Designed by David Dahl

PRODUCT FEATURES:

- Replacement hardware included with replacement arms and/or arm caps.
- Please specify frame finish and/or wood arm cap finish as applicable.

MODEL	PRODUCT SPECIFICATIONS	LIST
 7500-AR (Right Arm, As Seated)	Replacement Arm, No Arm Cap Guest/Tandem/Bariatric Models Weight: 4 lbs.	145
 7505-AC (Center Arm, As Seated)	Replacement Arm, No Arm Cap Guest/Tandem/Bariatric Models Weight: 4 lbs.	171
 7500-AL (Left Arm, As Seated)	Replacement Arm, No Arm Cap Guest/Tandem/Bariatric Models Weight: 4 lbs.	145
 7505-AR (Right Side, As Seated)	Replacement Frame Armless Guest/Tandem Models Weight: 3 lbs.	110
 7505-AC (Center, As Seated)	Replacement Frame Armless Guest/Tandem Models Weight: 3 lbs.	138
 7505-AL (Left Side, As Seated)	Replacement Frame Armless Guest/Tandem Models Weight: 3 lbs.	110
 7507-U (Black Urethane)	Replacement Black Urethane Arm Cap Guest/Tandem/Bariatric Models Weight: .5 lb.	40
 7507-W (Wood)	Replacement Wood Arm Cap Guest/Tandem/Bariatric Models Weight: .5 lb.	55
 7507-SF (Solid Surface)	Replacement Solid Surface Arm Cap Guest/Tandem/Bariatric Models Weight: 1 lb.	105

SUITE GUEST/TANDEM | Designed by David Dahl

UPHOLSTERY COMBINATIONS:

- For upholstery combinations, refer to the pricing below.
- When combining two COM/COV/COL fabrics, or fabrics with the same grade, add \$85 List per unit.
- When combining three or more COM/COV/COL fabrics, or fabrics with the same grade, add \$115 List per unit.
- When combining different grades of fabric, price will be based on the highest grade specified.
- Two-tone upholstery examples and yardage requirements for the most common combinations are listed below. Additional combinations available; please contact client services for yardage requirements and pricing.
- Note: Yardage amounts are based on fabric which is plain (i.e. non-directional) and a full 54" wide.
- Appropriate upholstery code must be included.



Code

Model

All Guest Units

SS1

COM Requirement

Back = .75 yd.

Balance of Chair = .75 yd.

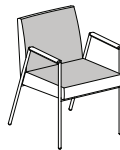

Code

Model

7510

7515

7511

7521

SS2

COM Requirement

Inside Back/Top of Seat = 1.25 yds.

Balance of Chair = .75 yd.



Code

Model

All Bariatric Units

SS3

COM Requirement

Back = 1.25 yds.

Balance of Chair = .75 yd.

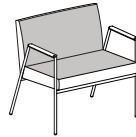

Code

Model

All Bariatric Units

SS4

COM Requirement

Inside Back/Top of Seat = 1.5 yds.

Balance of Chair = .75 yd.

SUITE LOUNGE | Designed by David Dahl



SPECIFICATIONS:

- Arm and armless models.
- Three arm cap options: beech wood, black urethane and solid surface.
- Wood arm caps available in all standard finishes on beech. Please refer to standard finish card.
- For custom wood finishes, please add \$450 List per color per order.
- Solid surface arm caps available in white only.
- Arm caps are field replaceable.
- Tubular steel frame.
- Three frame finish options. Please refer to listing below.
- Wall-saver leg design.
- 500 lb. weight capacity for lounge and 750 lb. weight capacity for love seat.
- All dimensions are nominal.
- Refer to terms and conditions for general information regarding fabrics, finishes, warranty, freight, complete condition of sales and more.

STANDARD METAL FRAME FINISH COLORS:





- #06 Charcoal Grey
- #90 Metallic Silver
- #91 Chrome

All shipments for this series will be blanket-wrapped as standard. If cartoning is required, a 5% upcharge will be added to each product. Please contact client services for additional information.

SUITE LOUNGE | Designed by David Dahl

ORDERING REQUIREMENTS:

- Model number
- Arm cap finish, as applicable
- Frame finish
- Upholstery selection
- Options, as applicable

MODEL	PRODUCT SPECIFICATIONS	FABRIC GRADES										LEATHER	
		COM	A	1	2	3	4	COL 5	6	7	8	L1	L2
7570 	Lounge Chair, Armless 22.5" W x 28.5" D x 31.75" H Seat: 20.5" W x 19.25" D Seat Ht: 18" COM: 1.5 yds. COL: 30 sq. ft. 30 lbs.	1,238	1,298	1,340	1,364	1,406	1,450	1,490	1,532	1,571	1,615	1,810	1,952
7575-U 	Lounge Chair, Black Urethane Arm Caps 23.25" W x 28.5" D x 31.75" H Seat: 20.5" W x 19.25" D Seat Ht: 18" Arm Ht: 25.25" COM: 1.5 yds. COL: 30 sq. ft. 30 lbs.	1,322	1,382	1,424	1,448	1,490	1,534	1,574	1,616	1,655	1,699	1,894	2,036
7575-W 	Lounge Chair, Wood Arm Caps 23.25" W x 28.5" D x 31.75" H Seat: 20.5" W x 19.25" D Seat Ht: 18" Arm Ht: 25.25" COM: 1.5 yds. COL: 30 sq. ft. 30 lbs.	1,322	1,382	1,424	1,448	1,490	1,534	1,574	1,616	1,655	1,699	1,894	2,036
7575-SF 	Lounge Chair, Solid Surface Arm Caps 23.25" W x 28.5" D x 31.75" H Seat: 20.5" W x 19.25" D Seat Ht: 18" Arm Ht: 25.25" COM: 1.5 yds. COL: 30 sq. ft. 30 lbs.	1,532	1,592	1,634	1,658	1,700	1,744	1,784	1,826	1,865	1,909	2,104	2,246

OPTIONS





-VCT04	VCT Tile Glides	\$24
-MB02	Moisture Barrier (seat only)	\$73

All shipments for this series will be blanket-wrapped as standard. If cartoning is required, a 5% upcharge will be added to each product. Please contact client services for additional information.

SUITE LOUNGE | Designed by David Dahl

ORDERING REQUIREMENTS:

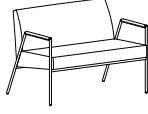
- Model number
- Arm cap finish, as applicable
- Frame finish
- Upholstery selection
- Options, as applicable

MODEL	PRODUCT SPECIFICATIONS	FABRIC GRADES								LEATHER			
		COM	A	1	2	3	4	COL 5	6	7	8	L1	L2
7580 	Love Seat, Armless 43.5" W x 28.75" D x 31.75" H Seat: 41.5" W x 19.25" D Seat Ht: 18" COM: 3 yds. COL: 60 sq. ft. 45 lbs.	1,790	1,910	1,994	2,042	2,126	2,213	2,294	2,378	2,456	2,543	2,933	3,218
7585-U 	Love Seat, Black Urethane Arm Caps 44.25" W x 28.75" D x 31.75" H Seat: 41.5" W x 19.25" D Seat Ht: 18" Arm Ht: 25.25" COM: 3 yds. COL: 60 sq. ft. 45 lbs.	1,873	1,993	2,077	2,125	2,209	2,296	2,377	2,461	2,539	2,626	3,016	3,301
7585-W 	Love Seat, Wood Arm Caps 44.25" W x 28.75" D x 31.75" H Seat: 41.5" W x 19.25" D Seat Ht: 18" Arm Ht: 25.25" COM: 3 yds. COL: 60 sq. ft. 45 lbs.	1,873	1,993	2,077	2,125	2,209	2,296	2,377	2,461	2,539	2,626	3,016	3,301
7585-SF 	Love Seat, Solid Surface Arm Caps 44.25" W x 28.75" D x 31.75" H Seat: 41.5" W x 19.25" D Seat Ht: 18" Arm Ht: 25.25" COM: 3 yds. COL: 60 sq. ft. 45 lbs.	2,083	2,203	2,287	2,335	2,419	2,506	2,587	2,671	2,749	2,836	3,226	3,511

OPTIONS







- VCT04 VCT Tile Glides \$24
- MB02 Moisture Barrier (seat only) \$73

All shipments for this series will be blanket-wrapped as standard. If cartoning is required, a 5% upcharge will be added to each product. Please contact client services for additional information.

SUITE LOUNGE | Designed by David Dahl

PRODUCT FEATURES:

- Replacement hardware included with replacement arms and/or arm caps.
- Please specify frame finish and/or wood arm cap finish as applicable.

MODEL	PRODUCT SPECIFICATIONS	LIST
 7575-AR (Right Arm, As Seated)	Replacement Arm, No Arm Cap Lounge/Love Seat Models Weight: 4 lbs.	167
 7575-AL (Left Arm, As Seated)	Replacement Arm, No Arm Cap Lounge/Love Seat Models Weight: 4 lbs.	167
 7570-AR (Right Side, As Seated)	Replacement Frame Armless Lounge/Love Seat Models Weight: 3 lbs.	132
 7570-AL (Left Side, As Seated)	Replacement Frame Armless Lounge/Love Seat Models Weight: 3 lbs.	132
 7597-U (Black Urethane)	Replacement Black Urethane Arm Cap Lounge/Love Seat Models Weight: .5 lb.	50
 7597-W (Wood)	Replacement Wood Arm Cap Lounge/Love Seat Models Weight: .5 lb.	63
 7597-SF (Solid Surface)	Replacement Solid Surface Arm Cap Lounge/Love Seat Models Weight: 1 lb.	105

SUITE LOUNGE | Designed by David Dahl

UPHOLSTERY COMBINATIONS:

- For upholstery combinations, refer to the pricing below.
- When combining two COM/COV/COL fabrics, or fabrics with the same grade, add \$85 List per unit.
- When combining three or more COM/COV/COL fabrics, or fabrics with the same grade, add \$115 List per unit.
- When combining different grades of fabric, price will be based on the highest grade specified.
- Two-tone upholstery examples and yardage requirements for the most common combinations are listed below. Additional combinations available; please contact client services for yardage requirements and pricing.
- Note: Yardage amounts are based on fabric which is plain (i.e. non-directional) and a full 54" wide.
- Appropriate upholstery code must be included.



Code
Model
7570
7575

SS5
COM Requirement
Back = .75 yd.
Balance of Chair = .75 yd.



Code
Model
7570
7575

SS6
COM Requirement
Inside Back/Top of Seat = 1.5 yds.
Balance of Chair = 1 yd.

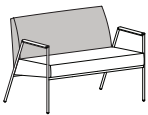

Code
Model
7580
7585

SS7
COM Requirement
Back = 1.5 yds.
Balance of Chair = 1.5 yds.



Code
Model
7580
7585

SS8
COM Requirement
Inside Back/Top of Seat = 1.5 yds.
Balance of Chair = 1 yd.

TWIRL™ GUEST | Designed by Chris & Jon Panichella



SPECIFICATIONS:

- Fully upholstered, wood and laminate back shell models available.
- Wood and laminate back shell models feature upholstered back cushion and fully upholstered seat.
- Laminate offered in three high gloss finishes. Please refer to listing below.
- All standard laminates also available at no upcharge. Please refer to standard finish card for options.
- Wood and laminate back shell models feature exposed plywood edge.
- Edge finish on wood back shell models will match veneer finish as standard.
- Edge finish on laminate back shell models will be clear-coat finish as standard.
- Four base options: 4-leg metal, metal swivel, 4-leg wood and wood swivel.
- Swivel base models feature self-return.
- Metal bases available in standard and premium finishes. Please refer to standard finish card.
- For custom metal finish colors, please contact client services for pricing.
- Wood offered in all standard and custom finishes on Ash. Please refer to standard finish card for options.
- For custom wood finishes, please contact client services and add one-time upcharge of \$450 List per color per order.
- 300 lb. weight capacity.
- All dimensions are nominal.
- Refer to terms and conditions for general information regarding fabrics, finishes, warranty, freight, complete condition of sales and more.

STANDARD METAL BASE FINISH COLORS:

- #06 Charcoal Grey
- #90 Metallic Silver
- #91 Chrome (4-leg base only)
- #92 Polished Aluminum (swivel base only)
- #95 Satin Black

PREMIUM METAL BASE FINISH COLORS:

- #07 Gold Shimmer
- #08 Penny
- #09 Brown Sugar
- #83 Metallic Champagne
- #94 Cotton

HIGH GLOSS LAMINATE FINISHES:

- Formica 459-90 Glossy Brite White
- Formica 909-90 Black
- Formica 928-90 Mouse

All shipments for this series will be blanket-wrapped as standard. If cartoning is required, a 5% upcharge will be added to each product. Please contact client services for additional information.

TWIRL™ GUEST | Designed by Chris & Jon Panichella

ORDERING REQUIREMENTS:

- Model number
- Wood back finish
- Base finish
- Upholstery selection
- Options, as applicable

MODEL	PRODUCT SPECIFICATIONS	FABRIC GRADES										LEATHER	
		COM	A	1	2	3	4	COL 5	6	7	8	L1	L2
60121-W	Guest Chair, 4-Leg Metal Base Wood Back with Upholstered Cushion 24.5" W x 23.5" D x 30" H Seat: 18" W x 18" D Seat Ht: 19" COM: 2 yds. COL: 40 sq. ft. 23 lbs.	1,173	1,253	1,309	1,341	1,397	1,455	1,509	1,565	1,617	1,675	1,935	2,125
60123-W	Guest Chair, Metal Swivel Base Wood Back with Upholstered Cushion 23.5" W x 23" D x 29.5" H Seat: 18" W x 18" D Seat Ht: 18.5" COM: 2 yds. COL: 40 sq. ft. 25 lbs.	1,284	1,364	1,420	1,452	1,508	1,566	1,620	1,676	1,728	1,786	2,046	2,236
60124-W	Guest Chair, 4-Leg Wood Base Wood Back with Upholstered Cushion 23.5" W x 25" D x 29.5" H Seat: 18" W x 18" D Seat Ht: 18.5" COM: 2 yds. COL: 40 sq. ft. 24 lbs.	1,185	1,265	1,321	1,353	1,409	1,467	1,521	1,577	1,629	1,687	1,947	2,137
60127-W	Guest Chair, Wood Swivel Base Wood Back with Upholstered Cushion 23.5" W x 24" D x 29.5" H Seat: 18" W x 18" D Seat Ht: 18.5" COM: 2 yds. COL: 40 sq. ft. 27 lbs.	1,429	1,509	1,565	1,597	1,653	1,711	1,765	1,821	1,873	1,931	2,191	2,381

OPTIONS

-PF02	Premium Metal Base Finish	\$80
-NS04	Non-Skid Glides (4-leg models only)	\$42
-NS04	Non-Skid Glides (swivel base models only)	\$42
-C02	Casters*	\$57

*Caster models feature 5-star base with swivel mechanism. Please apply upcharge to corresponding metal swivel base List price.

All shipments for this series will be blanket-wrapped as standard. If cartoning is required, a 5% upcharge will be added to each product. Please contact client services for additional information.

TWIRL™ GUEST | Designed by Chris & Jon Panichella

ORDERING REQUIREMENTS:

- Model number
- Laminate back finish
- Base finish
- Upholstery selection
- Options, as applicable

MODEL	PRODUCT SPECIFICATIONS	FABRIC GRADES										LEATHER	
		COM	A	1	2	3	4	COL 5	6	7	8	L1	L2
60121-L	Guest Chair, 4-Leg Metal Base Laminate Back with Upholstered Cushion 24.5" W x 23.5" D x 30" H Seat: 18" W x 18" D Seat Ht: 19" COM: 2 yds. COL: 40 sq. ft. 23 lbs.	1,117	1,197	1,253	1,285	1,341	1,399	1,453	1,509	1,561	1,619	1,879	2,069
60123-L	Guest Chair, Metal Swivel Base Laminate Back with Upholstered Cushion 23.5" W x 23" D x 29.5" H Seat: 18" W x 18" D Seat Ht: 18.5" COM: 2 yds. COL: 40 sq. ft. 25 lbs.	1,228	1,308	1,364	1,396	1,452	1,510	1,564	1,620	1,672	1,730	1,990	2,180
60124-L	Guest Chair, 4-Leg Wood Base Laminate Back with Upholstered Cushion 23.5" W x 25" D x 29.5" H Seat: 18" W x 18" D Seat Ht: 18.5" COM: 2 yds. COL: 40 sq. ft. 24 lbs.	1,148	1,228	1,284	1,316	1,372	1,430	1,484	1,540	1,592	1,650	1,910	2,100
60127-L	Guest Chair, Wood Swivel Base Laminate Back with Upholstered Cushion 23.5" W x 24" D x 29.5" H Seat: 18" W x 18" D Seat Ht: 18.5" COM: 2 yds. COL: 40 sq. ft. 27 lbs.	1,371	1,451	1,507	1,539	1,595	1,653	1,707	1,763	1,815	1,873	2,133	2,323

OPTIONS

-PF02	Premium Metal Base Finish	\$80
-NS04	Non-Skid Glides (4-leg models only)	\$42
-NS04	Non-Skid Glides (swivel base models only)	\$42
-C02	Casters (metal swivel base models only)	\$57

*Caster models feature 5-star base with swivel mechanism. Please apply upcharge to corresponding metal swivel base List price.

All shipments for this series will be blanket-wrapped as standard. If cartoning is required, a 5% upcharge will be added to each product. Please contact client services for additional information.

TWIRL™ GUEST | Designed by Chris & Jon Panichella

ORDERING REQUIREMENTS:

- Model number
- Base finish
- Upholstery selection
- Options, as applicable

MODEL	PRODUCT SPECIFICATIONS	FABRIC GRADES								LEATHER			
		COM	A	1	2	3	4	COL 5	6	7	8	L1	L2
60121-U	Guest Chair, 4-Leg Metal Base Fully Upholstered 25" W x 22" D x 30.5" H Seat: 18" W x 18" D Seat Ht: 19" COM: 2.25 yds. COL: 45 sq. ft. 25 lbs.	1,188	1,278	1,341	1,377	1,440	1,506	1,566	1,629	1,688	1,753	2,046	2,259
60123-U	Guest Chair, Metal Swivel Base Fully Upholstered 27.5" W x 27.5" D x 30" H Seat: 18" W x 18" D Seat Ht: 18.5" COM: 2.25 yds. COL: 45 sq. ft. 27 lbs.	1,297	1,387	1,450	1,486	1,549	1,615	1,675	1,738	1,797	1,862	2,155	2,368
60124-U	Guest Chair, 4-Leg Wood Base Fully Upholstered 25" W x 22" D x 30" H Seat: 18" W x 18" D Seat Ht: 18.5" COM: 2.25 yds. COL: 45 sq. ft. 26 lbs.	1,186	1,276	1,339	1,375	1,438	1,504	1,564	1,627	1,686	1,751	2,044	2,257
60127-U	Guest Chair, Wood Swivel Base Fully Upholstered 30.5" W x 30.5" D x 30" H Seat: 18" W x 18" D Seat Ht: 18.5" COM: 2.25 yds. COL: 45 sq. ft. 29 lbs.	1,438	1,528	1,591	1,627	1,690	1,756	1,816	1,879	1,938	2,003	2,296	2,509

OPTIONS

-PF02	Premium Metal Base Finish	\$80
-NS04	Non-Skid Glides (4-leg models only)	\$42
-NS04	Non-Skid Glides (swivel base models only)	\$42
-C02	Casters (metal swivel base models only)	\$57

*Caster models feature 5-star base with swivel mechanism. Please apply upcharge to corresponding metal swivel base List price.

TWIRL™ GUEST | Designed by Chris & Jon Panichella

UPHOLSTERY COMBINATIONS:

- For upholstery combinations, refer to the pricing below.
- When combining two COM/COV/COL fabrics, or fabrics with the same grade, add \$85 List per unit.
- When combining three or more COM/COV/COL fabrics, or fabrics with the same grade, add \$115 List per unit.
- When combining different grades of fabric, price will be based on the highest grade specified.
- Two-tone upholstery examples and yardage requirements for the most common combinations are listed below. Additional combinations available; please contact client services for yardage requirements and pricing.
- Note: Yardage amounts are based on fabric which is plain (i.e. non-directional) and a full 54" wide.
- Appropriate upholstery code must be included.



Code

Model

60121-U
60123-U
60124-U
60127-U

TW1

COM Requirement

Back Shell = 1.75 yds.
Balance of Chair = 1.25 yds.



Code

Model

60121-U
60123-U
60124-U
60127-U

TW2

COM Requirement

Back Shell & Seat Cushion = 2.5 yds.
Lower Side Panels = 1 yd.



Code

Model

60121-U
60123-U
60124-U
60127-U

TW3

COM Requirement

Back Shell & Lower Side Panels = 1.75 yds.
Seat Cushion = .75 yd.



Code

Model

60121-U
60123-U
60124-U
60127-U

TW4

COM Requirement

Inside Back Cushion & Seat Cushion = 1.5 yds.
Balance of Chair = 1.5 yds.



Code

Model

60121-W
60121-L
60123-W
60123-L
60124-W
60124-L
60127-W
60127-L

TW5

COM Requirement

Inside Back Cushion = 1 yd.
Balance of Chair = 1.25 yds.



Code

Model

60121-W
60121-L
60123-W
60123-L
60124-W
60124-L
60127-W
60127-L

TW6

COM Requirement

Inside Back Cushion & Seat Cushion = 1.5 yds.
Lower Side Panels = 1 yd.



Code

Model

60121-W
60121-L
60123-W
60123-L
60124-W
60124-L
60127-W
60127-L

TW7

COM Requirement

Inside Back Cushion & Lower Side Panels = 1.75 yds.
Seat Cushion = .75 yd.

TWIRL™ LOUNGE | Designed by Chris & Jon Panichella



SPECIFICATIONS:

- Mid- and high back models available fully upholstered or with wood or laminate back shell.
- Wood and laminate back shell models feature upholstered back cushion and fully upholstered seat.
- Laminate offered in three high gloss finishes. Please refer to listing below.
- All standard laminates also available at no upcharge. Please refer to standard finish card for options.
- Exposed plywood edge featured on wood and laminate back shell models.
- Edge finish on wood back shell models will match veneer finish as standard.
- Edge finish on laminate back shell models will be clear-coat finish as standard.
- Three base options: metal swivel, 4-leg wood and wood swivel.
- Swivel base models feature self-return.
- Metal swivel base offered in standard and premium finishes. See below for options.
- For custom metal finish colors, please contact client services for pricing.
- Wood offered in all standard and custom finishes on Ash. Please refer to standard finish card.
- For custom wood finishes, please contact client services and add one-time upcharge of \$450 List per color per order.
- 300 lb. weight capacity.
- All dimensions are nominal.
- Refer to terms and conditions for general information regarding fabrics, finishes, warranty, freight, complete condition of sales and more.

STANDARD METAL BASE FINISH COLORS:

- #06 Charcoal Grey
- #90 Metallic Silver
- #92 Polished Aluminum
- #95 Satin Black

PREMIUM METAL BASE FINISH COLORS:

- #07 Gold Shimmer
- #08 Penny
- #09 Brown Sugar
- #83 Metallic Champagne
- #94 Cotton

HIGH GLOSS LAMINATE FINISHES:

- Formica 459-90 Glossy Brite White
- Formica 909-90 Black
- Formica 928-90 Mouse

All shipments for this series will be blanket-wrapped as standard. If cartoning is required, a 5% upcharge will be added to each product. Please contact client services for additional information.

TWIRL™ LOUNGE | Designed by Chris & Jon Panichella

ORDERING REQUIREMENTS:

- Model number
- Wood finish
- Base finish
- Upholstery selection
- Options, as applicable

MODEL	PRODUCT SPECIFICATIONS	FABRIC GRADES										LEATHER	
		COM	A	1	2	3	4	COL 5	6	7	8	L1	L2
60223-M-W	Mid-Back Lounge Chair, Metal Swivel Base, Wood Back with Upholstered Cushion 29" W x 29.5" D x 32.75" H Seat: 19" W x 19" D Seat Ht: 16.5" COM: 2.5 yds. COL: 50 sq. ft. 35 lbs.	1,823	1,923	1,993	2,033	2,103	2,176	2,243	2,313	2,378	2,451	2,776	3,013
60224-M-W	Mid-Back Lounge Chair, 4-Leg Wood Base, Wood Back with Upholstered Cushion 29" W x 28.5" D x 32.75" H Seat: 19" W x 19" D Seat Ht: 16.5" COM: 2.5 yds. COL: 50 sq. ft. 34 lbs.	1,886	1,986	2,056	2,096	2,166	2,239	2,306	2,376	2,441	2,514	2,839	3,076
60227-M-W	Mid-Back Lounge Chair, Wood Swivel Base, Wood Back with Upholstered Cushion 29" W x 28.5" D x 32.75" H Seat: 19" W x 19" D Seat Ht: 16.5" COM: 2.5 yds. COL: 50 sq. ft. 37 lbs.	2,028	2,128	2,198	2,238	2,308	2,381	2,448	2,518	2,583	2,656	2,981	3,218

OPTIONS



-PF02	Premium Metal Base Finish	\$80
-NS04	Non-Skid Glides	\$42

All shipments for this series will be blanket-wrapped as standard. If cartoning is required, a 5% upcharge will be added to each product. Please contact client services for additional information.

TWIRL™ LOUNGE | Designed by Chris & Jon Panichella

ORDERING REQUIREMENTS:

- Model number
- Wood finish
- Base finish
- Upholstery selection
- Options, as applicable

MODEL	PRODUCT SPECIFICATIONS	FABRIC GRADES								LEATHER			
		COM	A	1	2	3	4	COL 5	6	7	8	L1	L2
60223-H-W 	High Back Lounge Chair, Metal Swivel Base, Wood Back with Upholstered Cushion 29" W x 32.25" D x 38.75" H Seat: 19" W x 19" D Seat Ht: 16.5" COM: 2.75 yds. COL: 55 sq. ft. 37 lbs.	1,954	2,064	2,141	2,185	2,262	2,342	2,416	2,493	2,565	2,645	3,002	3,263
60224-H-W 	High Back Lounge Chair, 4-Leg Wood Base, Wood Back with Upholstered Cushion 29" W x 31.25" D x 38.75" H Seat: 19" W x 19" D Seat Ht: 16.5" COM: 2.75 yds. COL: 55 sq. ft. 36 lbs.	2,016	2,126	2,203	2,247	2,324	2,404	2,478	2,555	2,627	2,707	3,064	3,325
60227-H-W 	High Back Lounge Chair, Wood Swivel Base, Wood Back with Upholstered Cushion 29" W x 31.25" D x 38.75" H Seat: 19" W x 19" D Seat Ht: 16.5" COM: 2.75 yds. COL: 55 sq. ft. 39 lbs.	2,159	2,269	2,346	2,390	2,467	2,547	2,621	2,698	2,770	2,850	3,207	3,468

OPTIONS

-PF02	Premium Metal Base Finish	\$80
-NS04	Non-Skid Glides	\$42

All shipments for this series will be blanket-wrapped as standard. If cartoning is required, a 5% upcharge will be added to each product. Please contact client services for additional information.

TWIRL™ LOUNGE | Designed by Chris & Jon Panichella

ORDERING REQUIREMENTS:

- Model number
- Laminate finish
- Base finish
- Upholstery selection
- Options, as applicable

MODEL	PRODUCT SPECIFICATIONS	FABRIC GRADES								LEATHER			
		COM	A	1	2	3	4	COL 5	6	7	8	L1	L2
60223-M-L	Mid-Back Lounge Chair, Metal Swivel Base, Laminate Back with Upholstered Cushion 29" W x 29.5" D x 32.75" H Seat: 19" W x 19" D Seat Ht: 16.5" COM: 2.5 yds. COL: 50 sq. ft. 35 lbs.	2,027	2,127	2,197	2,237	2,307	2,380	2,447	2,517	2,582	2,655	2,980	3,217
60224-M-L	Mid-Back Lounge Chair, 4-Leg Wood Base, Laminate Back with Upholstered Cushion 29" W x 28.5" D x 32.75" H Seat: 19" W x 19" D Seat Ht: 16.5" COM: 2.5 yds. COL: 50 sq. ft. 34 lbs.	2,090	2,190	2,260	2,300	2,370	2,443	2,510	2,580	2,645	2,718	3,043	3,280
60227-M-L	Mid-Back Lounge Chair, Wood Swivel Base, Laminate Back with Upholstered Cushion 29" W x 28.5" D x 32.75" H Seat: 19" W x 19" D Seat Ht: 16.5" COM: 2.5 yds. COL: 50 sq. ft. 37 lbs.	2,231	2,331	2,401	2,441	2,511	2,584	2,651	2,721	2,786	2,859	3,184	3,421

OPTIONS



-PF02	Premium Metal Base Finish	\$80
-NS04	Non-Skid Glides	\$42

All shipments for this series will be blanket-wrapped as standard. If cartoning is required, a 5% upcharge will be added to each product. Please contact client services for additional information.

TWIRL™ LOUNGE | Designed by Chris & Jon Panichella

ORDERING REQUIREMENTS:

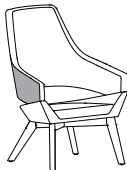
- Model number
- Laminate finish
- Base finish
- Upholstery selection
- Options, as applicable

MODEL	PRODUCT SPECIFICATIONS	FABRIC GRADES								LEATHER			
		COM	A	1	2	3	4	COL 5	6	7	8	L1	L2
60223-H-L 	High Back Lounge Chair, Metal Swivel Base, Laminate Back with Upholstered Cushion 29" W x 32.25" D x 38.75" H Seat: 19" W x 19" D Seat Ht: 16.5" COM: 2.75 yds. COL: 55 sq. ft. 37 lbs.	2,180	2,290	2,367	2,411	2,488	2,568	2,642	2,719	2,791	2,871	3,228	3,489
60224-H-L 	High Back Lounge Chair, 4-Leg Wood Base, Laminate Back with Upholstered Cushion 29" W x 31.25" D x 38.75" H Seat: 19" W x 19" D Seat Ht: 16.5" COM: 2.75 yds. COL: 55 sq. ft. 36 lbs.	2,242	2,352	2,429	2,473	2,550	2,630	2,704	2,781	2,853	2,933	3,290	3,551
60227-H-L 	High Back Lounge Chair, Wood Swivel Base, Laminate Back with Upholstered Cushion 29" W x 31.25" D x 38.75" H Seat: 19" W x 19" D Seat Ht: 16.5" COM: 2.75 yds. COL: 55 sq. ft. 39 lbs.	2,385	2,495	2,572	2,616	2,693	2,773	2,847	2,924	2,996	3,076	3,433	3,694

OPTIONS



-PF02	Premium Metal Base Finish	\$80
-NS04	Non-Skid Glides	\$42

All shipments for this series will be blanket-wrapped as standard. If cartoning is required, a 5% upcharge will be added to each product. Please contact client services for additional information.

TWIRL™ LOUNGE | Designed by Chris & Jon Panichella

ORDERING REQUIREMENTS:

- Model number
- Base finish
- Upholstery selection
- Options, as applicable

MODEL	PRODUCT SPECIFICATIONS	FABRIC GRADES								LEATHER			
		COM	A	1	2	3	4	COL 5	6	7	8	L1	L2
60223-M-U 	Mid-Back Lounge Chair, Metal Swivel Base, Fully Upholstered 29.5" W x 29.75" D x 33" H Seat: 19" W x 19" D Seat Ht: 16.5" COM: 3 yds. COL: 60 sq. ft. 35 lbs.	1,690	1,810	1,894	1,942	2,026	2,113	2,194	2,278	2,356	2,443	2,833	3,118
60224-M-U 	Mid-Back Lounge Chair, 4-Leg Wood Base, Fully Upholstered 29.5" W x 28.75" D x 33" H Seat: 19" W x 19" D Seat Ht: 16.5" COM: 3 yds. COL: 60 sq. ft. 34 lbs	1,752	1,872	1,956	2,004	2,088	2,175	2,256	2,340	2,418	2,505	2,895	3,180
60227-M-U 	Mid-Back Lounge Chair, Wood Swivel Base, Fully Upholstered 29.5" W x 28.75" D x 33" H Seat: 19" W x 19" D Seat Ht: 16.5" COM: 3 yds. COL: 60 sq. ft. 37 lbs.	1,895	2,015	2,099	2,147	2,231	2,318	2,399	2,483	2,561	2,648	3,038	3,323

OPTIONS

-PF02	Premium Metal Base Finish	\$80
-NS04	Non-Skid Glides	\$42

All shipments for this series will be blanket-wrapped as standard. If cartoning is required, a 5% upcharge will be added to each product. Please contact client services for additional information.

TWIRL™ LOUNGE | Designed by Chris & Jon Panichella

ORDERING REQUIREMENTS:

- Model number
- Base finish
- Upholstery selection
- Options, as applicable

MODEL	PRODUCT SPECIFICATIONS	FABRIC GRADES								LEATHER			
		COM	A	1	2	3	4	COL 5	6	7	8	L1	L2
60223-H-U	High Back Lounge Chair, Metal Swivel Base, Fully Upholstered 29.5" W x 33" D x 39" H Seat: 19" W x 19" D Seat Ht: 16.5" COM: 3.5 yds. COL: 70 sq. ft. 37 lbs.	1,794	1,934	2,032	2,088	2,186	2,288	2,382	2,480	2,571	2,673	3,128	3,460
60224-H-U	High Back Lounge Chair, 4-Leg Wood Base, Fully Upholstered 29.5" W x 32" D x 39" H Seat: 19" W x 19" D Seat Ht: 16.5" COM: 3.5 yds. COL: 70 sq. ft. 36 lbs.	1,857	1,997	2,095	2,151	2,249	2,351	2,445	2,543	2,634	2,736	3,191	3,523
60227-H-U	High Back Lounge Chair, Wood Swivel Base, Fully Upholstered 29.5" W x 32" D x 39" H Seat: 19" W x 19" D Seat Ht: 16.5" COM: 3.5 yds. COL: 70 sq. ft. 39 lbs.	2,000	2,140	2,238	2,294	2,392	2,494	2,588	2,686	2,777	2,879	3,334	3,666

OPTIONS

- PF02 Premium Metal Base Finish \$80
- NS04 Non-Skid Glides \$42

TWIRL™ LOUNGE | Designed by Chris & Jon Panichella

UPHOLSTERY COMBINATIONS:

- For upholstery combinations, refer to the pricing below.
- When combining two COM/COV/COL fabrics, or fabrics with the same grade, add \$85 List per unit.
- When combining three or more COM/COV/COL fabrics, or fabrics with the same grade, add \$115 List per unit.
- When combining different grades of fabric, price will be based on the highest grade specified.
- Two-tone upholstery examples and yardage requirements for the most common combinations are listed below. Additional combinations available; please contact client services for yardage requirements and pricing.
- Note: Yardage amounts are based on fabric which is plain (i.e. non-directional) and a full 54" wide.
- Appropriate upholstery code must be included.



Code	TW8
<u>Model</u>	<u>COM Requirement</u>
60223-M-U	Back Shell = 1.5 yds.
60224-M-U	Balance of Chair = 1.75 yds.
60227-M-U	

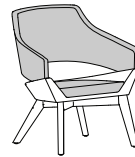

Code	TW9
<u>Model</u>	<u>COM Requirement</u>
60223-M-U	Back Shell & Seat Cushion = 2.5 yds.
60224-M-U	Lower Side Panels = 1.25 yds.
60227-M-U	



Code	TW10
<u>Model</u>	<u>COM Requirement</u>
60223-M-U	Back Shell & Lower Side Panels = 2.5 yds.
60224-M-U	Seat Cushion = .75 yd.
60227-M-U	

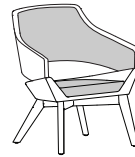

Code	TW11
<u>Model</u>	<u>COM Requirement</u>
60223_M-U	Inside Back Cushion & Seat Cushion = 1.5 yds.
60224-M-U	Balance of Chair = 1.5 yds.
60227-M-U	

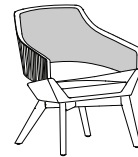

Code	TW12
<u>Model</u>	<u>COM Requirement</u>
60223-M-W	Inside Back Cushion = 1 yd.
60223-M-L	Balance of Chair = 1.75 yds.
60224-M-W	
60224-M-L	
60227-M-W	
60227-M-L	



Code	TW13
<u>Model</u>	<u>COM Requirement</u>
60223-M-W	Inside Back Cushion & Seat Cushion = 1.5 yds.
60223-M-L	Lower Side Panels = 2 yds.
60224-M-W	
60224-M-L	
60227-M-W	
60227-M-L	



Code	TW14
<u>Model</u>	<u>COM Requirement</u>
60223-M-W	Inside Back Cushion & Lower Side Panels = 2 yds.
60223-M-L	Seat Cushion = .75 yd.
60224-M-W	
60224-M-L	
60227-M-W	
60227-M-L	

TWIRL™ LOUNGE | Designed by Chris & Jon Panichella

UPHOLSTERY COMBINATIONS:

- For upholstery combinations, refer to the pricing below.
- When combining two COM/COV/COL fabrics, or fabrics with the same grade, add \$85 List per unit.
- When combining three or more COM/COV/COL fabrics, or fabrics with the same grade, add \$115 List per unit.
- When combining different grades of fabric, price will be based on the highest grade specified.
- Two-tone upholstery examples and yardage requirements for the most common combinations are listed below. Additional combinations available; please contact client services for yardage requirements and pricing.
- Note: Yardage amounts are based on fabric which is plain (i.e. non-directional) and a full 54" wide.
- Appropriate upholstery code must be included.

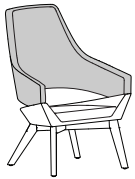

Code **TW15**
Model COM Requirement
 60223-H-U Back Shell = 1.75 yd.
 60224-H-U Balance of Chair = 1.75 yds.
 60227-H-U

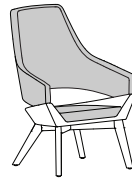

Code **TW16**
Model COM Requirement
 60223-H-U Back Shell & Seat Cushion = 2.75 yds.
 60224-H-U Lower Side Panels = 1.25 yds.
 60227-H-U

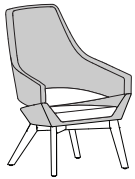

Code **TW17**
Model COM Requirement
 60223-H-U Back Shell & Lower Side Panels = 2.75 yds.
 60224-H-U Seat Cushion = 1 yd.
 60227-H-U

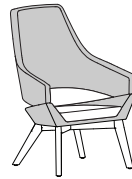

Code **TW18**
Model COM Requirement
 60223-H-U Inside Back Cushion & Seat Cushion = 1.75 yds.
 60224-H-U Balance of Chair = 1.5 yds.
 60227-H-U

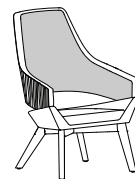

Code **TW19**
Model COM Requirement
 60223-H-W Inside Back Cushion = 1 yd.
 60223-H-L Balance of Chair = 1.75 yds.
 60224-H-W
 60224-H-L
 60227-H-W
 60227-H-L

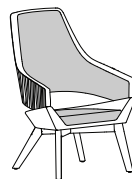

Code **TW20**
Model COM Requirement
 60223-H-W Inside Back Cushion & Seat Cushion = 1.75 yds.
 60223-H-L Lower Side Panels = 1.5 yds.
 60224-H-W
 60224-H-L
 60227-H-W
 60227-H-L

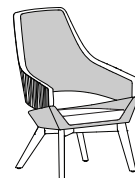

Code **TW21**
Model COM Requirement
 60223-H-W Inside Back Cushion & Lower Side Panels = 2.25 yds.
 60223-H-L Seat Cushion = .75 yd.
 60224-H-W
 60224-H-L
 60227-H-W
 60227-H-L

VISOR LOUNGE | Designed by 5d Studio



SPECIFICATIONS:

- Lounge and love seat models available in Public and Private options.
- Sled base available in four standard finishes: #06 Charcoal Grey, #90 Metallic Silver, #91 Chrome and #95 Satin Black.
- Premium finishes also available. Please refer to standard finish card.
- Swivel base lounge chair also offered.
- Swivel base is finished in stainless steel and features 360-degree turning radius with self-return.
- Lounge unit weight capacity: 350 lbs. Love seat weight capacity: 700 lbs.
- Optional contrasting welt offered on Private panels.
- Non-skid glides available for hard surface floors.
- All dimensions are nominal.
- Refer to terms and conditions for general information regarding fabrics, finishes, warranty, freight, complete condition of sales and more.

ROTATING TABLE:

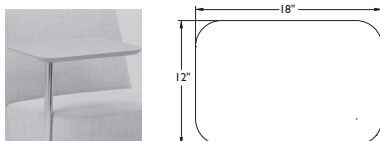

- Tablet is .75" thick, features 360-degree turning radius and is available on all Public seating units.
- Three surface options: laminate, solid surface and back-painted glass.
- Laminate and solid surface tops feature an exposed wood edge with clear-coat finish as standard.
- Solid surface available in white only.
- Glass tops are back-painted white as standard.
- For standard laminate colors, refer to standard finish card.
- For non-standard laminates, add \$550 List per color per order. Pre-approval required, please contact client services.
- For maximum durability, a laminate or solid surface with a clear-coat edge finish is recommended.
- Tablet mounting bracket will match corresponding seating unit base finish unless specified otherwise.
- 100 lb. weight capacity.

CUP HOLDER:



- Available on Private lounge units.
- Dimensions: 5" outer diameter, 3.5" inner diameter (cup size) x .25" deep.
- #92 Polished Aluminum finish.
- Black laminate insert.

All shipments for this series will be blanket-wrapped as standard. If cartoning is required, a 5% upcharge will be added to each product. Please contact client services for additional information.

VISOR LOUNGE | Designed by 5d Studio

ORDERING REQUIREMENTS:

- Model number
- Upholstery selection
- Options, as applicable

MODEL	PRODUCT SPECIFICATIONS	FABRIC GRADES										LEATHER	
		COM	A	1	2	3	4	COL 5	6	7	8	L1	L2
7725 	Public Lounge, Swivel Base 27.5" W x 28.5" D x 31.5" H Seat: 27.5" W x 19" D Seat Ht: 17.5" COM: 2 yds. COL: 40 sq. ft. 74 lbs.	1,325	1,405	1,461	1,493	1,549	1,607	1,661	1,717	1,769	1,827	2,087	2,277
7725-SP 	Semi-Private Lounge, Swivel Base 29.5" W x 30" D x 47.5" H Seat: 27.5" W x 19" D Seat Ht: 17.5" COM: 4.5 yds. COL: 90 sq. ft. 99 lbs.	1,981	2,161	2,287	2,359	2,485	2,616	2,737	2,863	2,980	3,111	3,696	4,123
7725-PR 	Private Lounge, Swivel Base 31.5" W x 30" D x 47.5" H Seat: 27.5" W x 19" D Seat Ht: 17.5" COM: 6 yds. COL: 120 sq. ft. 103 lbs.	2,029	2,269	2,437	2,533	2,701	2,875	3,037	3,205	3,361	3,535	4,315	4,885
XXXX-XX-CW	Privacy Panel Contrasting Welt COM: 1 yd. COL: n/a	155	195	223	239	267	296	323	351	377	406	n/a	n/a

OPTIONS - PUBLIC AND SEMI-PRIVATE MODELS

-TAR03-L	Laminate Rotating Tablet, Right (as seated)	\$497
-TAL03-L	Laminate Rotating Tablet, Left (as seated)	\$497
-TAR03-SF	Solid Surface Rotating Tablet, Right (as seated)	\$547
-TAL03-SF	Solid Surface Rotating Tablet, Left (as seated)	\$547
-TAR03-GL	Back-Painted Glass Rotating Tablet, Right (as seated)	\$684
-TAL03-GL	Back-Painted Glass Rotating Tablet, Left (as seated)	\$684
-MB01	Moisture Barrier (seat only)	\$52

OPTIONS - PRIVATE MODELS



-CHR01	Cup Holder, Right (as seated)	\$170
-CHL01	Cup Holder, Left (as seated)	\$170
-MB01	Moisture Barrier (seat only)	\$52

All shipments for this series will be blanket-wrapped as standard. If cartoning is required, a 5% upcharge will be added to each product. Please contact client services for additional information.

VISOR LOUNGE | Designed by 5d Studio

ORDERING REQUIREMENTS:

- Model number
- Base finish
- Upholstery selection
- Options, as applicable

MODEL	PRODUCT SPECIFICATIONS	FABRIC GRADES										LEATHER	
		COM	A	1	2	3	4	COL 5	6	7	8	L1	L2
7701 	Public Lounge, Sled Base 27.5" W x 28.5" D x 31.5" H Seat: 27.5" W x 19" D Seat Ht: 17.5" COM: 2 yds. COL: 40 sq. ft. 30 lbs.	1,082	1,162	1,218	1,250	1,306	1,364	1,418	1,474	1,526	1,584	1,844	2,034
7701-SP 	Semi-Private Lounge, Sled Base 29.5" W x 30" D x 47.5" H Seat: 27.5" W x 19" D Seat Ht: 17.5" COM: 4.5 yds. COL: 90 sq. ft. 53 lbs.	1,737	1,917	2,043	2,115	2,241	2,372	2,493	2,619	2,736	2,867	3,452	3,879
7701-PR 	Private Lounge, Sled Base 31.5" W x 30" D x 47.5" H Seat: 27.5" W x 19" D Seat Ht: 17.5" COM: 6 yds. COL: 120 sq. ft. 58 lbs.	1,785	2,025	2,193	2,289	2,457	2,631	2,793	2,961	3,117	3,291	4,071	4,641
XXXX-XX-CW	Privacy Panel Contrasting Welt COM: 1 yd. COL: n/a	155	195	223	239	267	296	323	351	377	406	n/a	n/a

OPTIONS - PUBLIC AND SEMI-PRIVATE MODELS

-PF02	Premium Metal Base Finish	\$80
-NS04	Non-Skid Glides	\$42
-MB01	Moisture Barrier (seat only)	\$52
-TAR03-L	Laminate Rotating Tablet, Right (as seated)	\$497
-TAL03-L	Laminate Rotating Tablet, Left (as seated)	\$497
-TAR03-SF	Solid Surface Rotating Tablet, Right (as seated)	\$547
-TAL03-SF	Solid Surface Rotating Tablet, Left (as seated)	\$547
-TAR03-GL	Back-Painted Glass Rotating Tablet, Right (as seated)	\$684
-TAL03-GL	Back-Painted Glass Rotating Tablet, Left (as seated)	\$684

OPTIONS - PRIVATE MODELS



-PF02	Premium Metal Base Finish	\$80
-CHR01	Cup Holder, Right (as seated)	\$170
-CHL01	Cup Holder, Left (as seated)	\$170
-NS04	Non-Skid Glides	\$42
-MB01	Moisture Barrier (seat only)	\$52

All shipments for this series will be blanket-wrapped as standard. If cartoning is required, a 5% upcharge will be added to each product. Please contact client services for additional information.

VISOR LOUNGE | Designed by 5d Studio

ORDERING REQUIREMENTS:

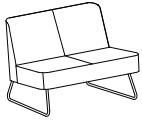
- Model number
- Base finish
- Upholstery selection
- Options, as applicable

MODEL	PRODUCT SPECIFICATIONS	FABRIC GRADES										LEATHER	
		COM	A	1	2	3	4	COL 5	6	7	8	L1	L2
7702 	Public Love Seat 45" W x 28.5" D x 31.5" H Seat: 45" W x 19" D Seat Ht: 17.5" COM: 2.75 yds. COL: 55 sq. ft. 44 lbs.	1,560	1,670	1,747	1,791	1,868	1,948	2,022	2,099	2,171	2,251	2,608	2,869
7702-SP 	Semi-Private Love Seat 47" W x 30" D x 47.5" H Seat: 45" W x 19" D Seat Ht: 17.5" COM: 5.75 yds. COL: 115 sq. ft. 68 lbs.	2,339	2,569	2,730	2,822	2,983	3,150	3,305	3,466	3,616	3,783	4,530	5,076
7702-PR 	Private Love Seat 49" W x 30" D x 47.5" H Seat: 45" W x 19" D Seat Ht: 17.5" COM: 6.5 yds. COL: 130 sq. ft. 80 lbs.	2,385	2,645	2,827	2,931	3,113	3,302	3,477	3,659	3,828	4,017	4,862	5,479
XXXX-XX-CW	Privacy Panel Contrasting Welt COM: 1 yd. COL: n/a	212	252	280	296	324	353	380	408	434	463	n/a	n/a

OPTIONS - PUBLIC AND SEMI-PRIVATE MODELS

-PF02	Premium Metal Base Finish	\$80
-NS04	Non-Skid Glides	\$42
-MB02	Moisture Barrier (seat only)	\$70
-TAR03-L	Laminate Rotating Tablet, Right (as seated)	\$497
-TAL03-L	Laminate Rotating Tablet, Left (as seated)	\$497
-TAR03-SF	Solid Surface Rotating Tablet, Right (as seated)	\$547
-TAL03-SF	Solid Surface Rotating Tablet, Left (as seated)	\$547
-TAR03-GL	Back-Painted Glass Rotating Tablet, Right (as seated)	\$684
-TAL03-GL	Back-Painted Glass Rotating Tablet, Left (as seated)	\$684

OPTIONS - PRIVATE MODELS

-PF02	Premium Metal Base Finish	\$80
-CHR01	Cup Holder, Right (as seated)	\$170
-CHL01	Cup Holder, Left (as seated)	\$170
-NS04	Non-Skid Glides	\$42
-MB02	Moisture Barrier (seat only)	\$73

VISOR LOUNGE | Designed by 5d Studio

UPHOLSTERY COMBINATIONS:

- For upholstery combinations, refer to the pricing below.
- When combining two COM/COV/COL fabrics, or fabrics with the same grade, add \$85 List per unit.
- When combining three or more COM/COV/COL fabrics, or fabrics with the same grade, add \$115 List per unit.
- When combining different grades of fabric, price will be based on the highest grade specified.
- Two-tone upholstery examples and yardage requirements for the most common combinations are listed below. Additional combinations available; please contact client services for yardage requirements and pricing.
- Note: Yardage amounts are based on fabric which is plain (i.e. non-directional) and a full 54" wide.
- Appropriate upholstery code must be included.



Code VS1
Model
 7725
COM Requirement
 Back = 1.5 yds.
 Seat = 1 yd.

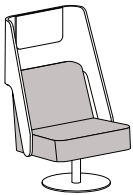

Code VS2
Model
 7725-SP
COM Requirement
 Privacy Panel = 2.5 yds.
 Back & Seat = 2.5 yds.

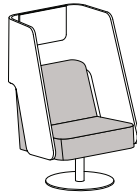

Code VS3
Model
 7725-PR
COM Requirement
 Privacy Panel = 4 yds.
 Back & Seat = 2.5 yds.

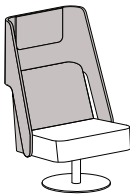

Code VS4
Model
 7725-SP
COM Requirement
 Privacy Panel & Back = 4 yds.
 Seat = 1 yd.

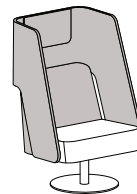

Code VS5
Model
 7725-PR
COM Requirement
 Privacy Panel & Back = 5.5 yds.
 Seat = 1 yd.

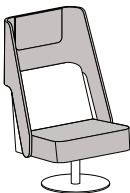

Code VS6
Model
 7725-SP
COM Requirement
 Privacy Panel & Seat = 3.5 yds.
 Back = 1.5 yds.

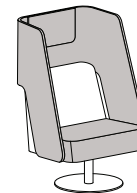

Code VS7
Model
 7725-PR
COM Requirement
 Privacy Panel & Seat = 5 yds.
 Back = 1.5 yds.

VISOR LOUNGE | Designed by 5d Studio

UPHOLSTERY COMBINATIONS:

- For upholstery combinations, refer to the pricing below.
- When combining two COM/COV/COL fabrics, or fabrics with the same grade, add \$85 List per unit.
- When combining three or more COM/COV/COL fabrics, or fabrics with the same grade, add \$115 List per unit.
- When combining different grades of fabric, price will be based on the highest grade specified.
- Two-tone upholstery examples and yardage requirements for the most common combinations are listed below. Additional combinations available; please contact client services for yardage requirements and pricing.
- Note: Yardage amounts are based on fabric which is plain (i.e. non-directional) and a full 54" wide.
- Appropriate upholstery code must be included.



Code

Model

7701
7701-M

VS8

COM Requirement

Back = 1.5 yds.
Seat = 1 yd.

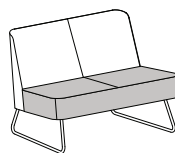

Code

Model

7702
7702-M

VS9

COM Requirement

Back = 1.5 yds.
Seat = 1.5 yds.

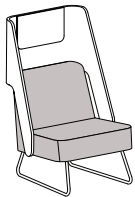

Code

Model

7701-SP

VS10

COM Requirement

Privacy Panel = 2.5 yds.
Back & Seat = 2.5 yds.

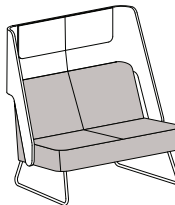

Code

Model

7702-SP

VS11

COM Requirement

Privacy Panel = 3 yds.
Back & Seat = 3 yds.

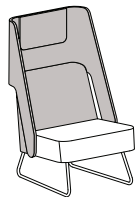

Code

Model

7701-SP

VS12

COM Requirement

Privacy Panel & Back = 4 yds.
Seat = 1 yd.

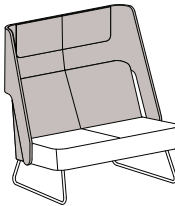

Code

Model

7702-SP

VS13

COM Requirement

Privacy Panel & Back = 5 yds.
Seat = 1.5 yds.

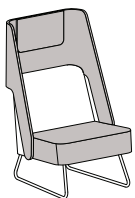

Code

Model

7701-SP

VS14

COM Requirement

Privacy Panel & Seat = 3.5 yds.
Back = 1.5 yds.

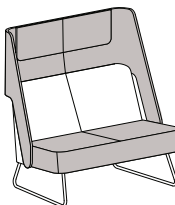

Code

Model

7702-SP

VS15

COM Requirement

Privacy Panel & Seat = 4.5 yds.
Back = 1.5 yds.

VISOR LOUNGE | Designed by 5d Studio

UPHOLSTERY COMBINATIONS:

- For upholstery combinations, refer to the pricing below.
- When combining two COM/COV/COL fabrics, or fabrics with the same grade, add \$85 List per unit.
- When combining three or more COM/COV/COL fabrics, or fabrics with the same grade, add \$115 List per unit.
- When combining different grades of fabric, price will be based on the highest grade specified.
- Two-tone upholstery examples and yardage requirements for the most common combinations are listed below. Additional combinations available; please contact client services for yardage requirements and pricing.
- Note: Yardage amounts are based on fabric which is plain (i.e. non-directional) and a full 54" wide.
- Appropriate upholstery code must be included.

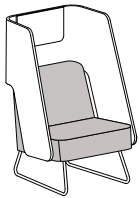

Code
Model
7701-PR

VS16
COM Requirement
Privacy Panel = 4 yds.
Back & Seat = 2.5 yds.

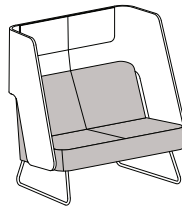

Code
Model
7702-PR

VS17
COM Requirement
Privacy Panel = 4 yds.
Back & Seat = 3 yds.

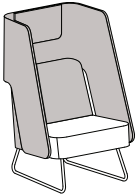

Code
Model
7701-PR

VS18
COM Requirement
Privacy Panel & Back = 5.5 yds.
Seat = 1 yd.

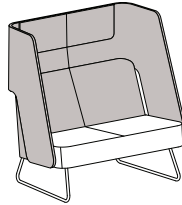

Code
Model
7702-PR

VS19
COM Requirement
Privacy Panel & Back = 5.5 yds.
Seat = 1.5 yds.

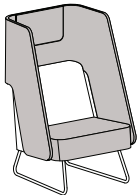

Code
Model
7701-PR

VS20
COM Requirement
Privacy Panel & Seat = 5 yds.
Back = 1.5 yds.

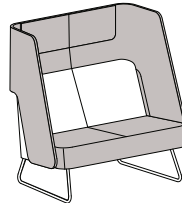

Code
Model
7702-PR

VS21
COM Requirement
Privacy Panel & Seat = 5.5 yds.
Back = 1.5 yds.

VISOR MODULAR | Designed by David Ritch and Mark Saffell of 5d Studio



PRODUCT FEATURES:

- Sled base offered in standard and premium finishes. See following page for options.
- For custom metal finish colors, please contact client services for pricing.
- All dimensions are nominal.
- Refer to terms and conditions for general information regarding fabrics, finishes, warranty, freight, complete condition of sales and more.
- Please include layout drawings or sketch with each order.

MODULAR LOUNGE SEATING:

- Lounge and love seat models available in straight and wedge-shaped options.
- Offered individually or in modular combinations.
- Straight seating units available in Public and Semi-Private styles.
- Wedge-shaped seating units available in Public style only.
- For chair-to-chair connection, wedge-shaped seating units must be specified.
- Non-skid glides offered for hard surface floors.
- Optional contrasting welt offered on Semi-Private panels. An additional COM requirement also applies.
- Optional accessories sold separately.
- Lounge unit weight capacity: 350 lbs. Love seat weight capacity: 700 lbs.
- Optional ganging connector available for chair-to-chair connection. Please specify quantity and add \$50 List per set. One set contains two brackets for connecting two units together.

CONNECTING TABLES:

- Connecting tables available for configuration with all modular seating units.
- Multiple sizes and shapes available. Please refer to individual pages for details.
- Table description indicates seating configuration angle.
- 2.5" table thickness.
- Laminate, solid surface and back-painted glass top surface options with laminate edge.
- For standard laminate colors, refer to standard finish card.
- For non-standard laminates, add \$550 List per color per order. Pre-approval required, please contact client services.
- Solid surface available in white only.
- Glass tops are back-painted white as standard and may be used as a writable surface with dry-erase markers.
- Tables with laminate top, edge finish will match top finish as standard.
- Tables with solid surface and back-painted glass top, please specify laminate edge finish.
- For all table widths, wood grain laminates will run parallel to width of table.

VISOR MODULAR | Designed by David Ritch and Mark Saffell of 5d Studio

ROTATING TABLET:

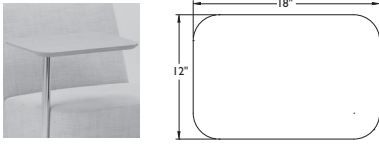

- Tablet is .75" thick, features 360-degree turning radius and is available on all Public seating units.
- Three surface options: laminate, solid surface and back-painted glass.
- For standard laminate colors, refer to standard finish card.
- For non-standard laminates, add \$550 List per color per order. Pre-approval required, please contact client services.
- Solid surface available in white only.
- Glass tops are back-painted white as standard.
- Laminate and solid surface tops feature an exposed wood edge with clear-coat finish as standard.
- For maximum durability, a laminate or solid surface with a clear-coat edge finish is recommended.
- Tablet mounting bracket will match corresponding seating unit base finish unless specified otherwise.
- For 8" W tables, tablet placement will be centered.
- For 15" W tables, please specify tablet placement as left, center or right, as seated.
- For 30-degree and 45-degree tables, please specify tablet placement as left, center or right, as seated.
- For 90-degree tables, tablet placement will be centered.
- Rotating tablet post will match base finish unless specified otherwise.
- 100 lb. weight capacity.

STANDARD METAL BASE FINISH COLORS:

- #06 Charcoal Grey
- #90 Metallic Silver
- #91 Chrome
- #95 Satin Black

PREMIUM METAL BASE FINISH COLORS:

- #07 Gold Shimmer
- #08 Penny
- #09 Brown Sugar
- #83 Metallic Champagne
- #94 Cotton

MODULAR ARRANGEMENTS:

- Optional ganging connector available on wedge-shaped seating units for seat-to-seat connection. Please specify "-GC10" with quantity and add \$50 List per set. One set contains two brackets for connecting two units together.
- Field assembly required.
- **Note: Layout drawings or sketch is required with each order.**

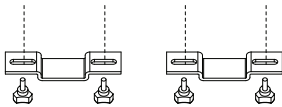

All shipments for this series will be blanket-wrapped as standard. If cartoning is required, a 5% upcharge will be added to each product. Please contact client services for additional information.

VISOR MODULAR | Designed by David Ritch and Mark Saffell of 5d Studio

ORDERING REQUIREMENTS:

- Model number
- Base finish
- Upholstery selection
- Options, as applicable

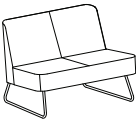
MODEL	PRODUCT SPECIFICATIONS	FABRIC GRADES								LEATHER			
		COM	A	1	2	3	4	COL 5	6	7	8	L1	L2
7701-M 	Public Modular Lounge Unit 27.5" W x 28.5" D x 31.5" H Seat: 27.5" W x 19" D Seat Ht: 17.5" COM: 2 yds. COL: 40 sq. ft. 30 lbs.	1,082	1,162	1,218	1,250	1,306	1,364	1,418	1,474	1,526	1,584	1,844	2,034
7702-M 	Public Modular Love Seat 45" W x 28.5" D x 31.5" H Seat: 45" W x 19" D Seat Ht: 17.5" COM: 2.75 yds. COL: 55 sq. ft. 44 lbs.	1,560	1,670	1,747	1,791	1,868	1,948	2,022	2,099	2,171	2,251	2,608	2,869

OPTIONS



-PF02	Premium Metal Base Finish	\$80	-TAR03-L	Laminate Rotating Tablet, Right (as seated)	\$497
-NS04	Non-Skid Glides	\$42	-TAL03-L	Laminate Rotating Tablet, Left (as seated)	\$497
-MB01	Moisture Barrier (lounge, seat only)	\$52	-TAR03-SF	Solid Surface Rotating Tablet, Right (as seated)	\$547
-MB02	Moisture Barrier (love seat, seat only)	\$73	-TAL03-SF	Solid Surface Rotating Tablet, Left (as seated)	\$547
			-TAR03-GL	Back-Painted Glass Rotating Tablet, Right (as seated)	\$684
			-TAL03-GL	Back-Painted Glass Rotating Tablet, Left (as seated)	\$684

All shipments for this series will be blanket-wrapped as standard. If cartoning is required, a 5% upcharge will be added to each product. Please contact client services for additional information.

VISOR MODULAR | Designed by David Ritch and Mark Saffell of 5d Studio

ORDERING REQUIREMENTS:

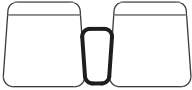
- Model number
- Top finish
- Edge finish
- Options, as applicable
- Layout drawing or sketch

MODEL	PRODUCT SPECIFICATIONS	LAMINATE TOP (-L)	SOLID SURFACE TOP (-SF)	BACK-PAINTED GLASS TOP (-GL)	WEIGHT
7730-8-() 	8" Wide Straight Table 9.75" W x 18" D	530	613	624	6
7730-15-() 	15" Wide Straight Table 16.75" W x 18" D	571	695	689	10

OPTIONS

-TAR03-L	Laminate Rotating Tablet, Right (as seated)	\$497	-TAR03-GL	Back-Painted Glass Rotating Tablet, Right (as seated)	\$684
-TAC03-L	Laminate Rotating Tablet, Center	\$497	-TAC03-GL	Back-Painted Glass Rotating Tablet, Center	\$684
-TAL03-L	Laminate Rotating Tablet, Left (as seated)	\$497	-TAL03-GL	Back-Painted Glass Rotating Tablet, Left (as seated)	\$684
-TAR03-SF	Solid Surface Rotating Tablet, Right (as seated)	\$547			
-TAC03-SF	Solid Surface Rotating Tablet, Center	\$547			
-TAL03-SF	Solid Surface Rotating Tablet, Left (as seated)	\$547			

Please Note That Tablet Placement on 8" Wide Straight Table is Centered (Left/Right Not Available).

All shipments for this series will be blanket-wrapped as standard. If cartoning is required, a 5% upcharge will be added to each product. Please contact client services for additional information.

VISOR MODULAR | Designed by David Ritch and Mark Saffell of 5d Studio

ORDERING REQUIREMENTS:

- Model number
- Top finish
- Edge finish
- Options, as applicable
- Layout drawing or sketch

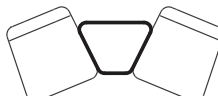
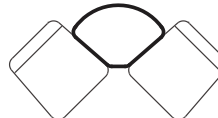
MODEL	PRODUCT SPECIFICATIONS	LAMINATE TOP (-L)	SOLID SURFACE TOP (-SF)	BACK-PAINTED GLASS TOP (-GL)	WEIGHT
7731-30-() 	30-Degree Table, Inside Wedge 24.25" W x 18" D	595	802	797	12
7731-45-() 	45-Degree Table, Inside Wedge 25.5" W x 18" D	595	802	797	11
7731-90-() 	90-Degree Table, Inside Wedge 32" W x 24.5" D	673	1,017	1,007	14

OPTIONS

-TAR03-L	Laminate Rotating Tablet, Right (as seated)	\$497	-TAR03-GL	Back-Painted Glass Rotating Tablet, Right (as seated)	\$684
-TAC03-L	Laminate Rotating Tablet, Center	\$497	-TAC03-GL	Back-Painted Glass Rotating Tablet, Center	\$684
-TAL03-L	Laminate Rotating Tablet, Left (as seated)	\$497	-TAL03-GL	Back-Painted Glass Rotating Tablet, Left (as seated)	\$684
-TAR03-SF	Solid Surface Rotating Tablet, Right (as seated)	\$547			
-TAC03-SF	Solid Surface Rotating Tablet, Center	\$547			
-TAL03-SF	Solid Surface Rotating Tablet, Left (as seated)	\$547			



Please Note That Tablet Placement on 90-Degree Inside Wedge Table is Centered (Left/Right Placement Not Available).

All shipments for this series will be blanket-wrapped as standard. If cartoning is required, a 5% upcharge will be added to each product. Please contact client services for additional information.

VISOR MODULAR | Designed by David Ritch and Mark Saffell of 5d Studio

ORDERING REQUIREMENTS:

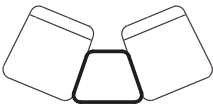
- Model number
- Top finish
- Edge finish
- Options, as applicable
- Layout drawing or sketch

MODEL	PRODUCT SPECIFICATIONS	LAMINATE TOP (-L)	SOLID SURFACE TOP (-SF)	BACK-PAINTED GLASS TOP (-GL)	WEIGHT
7732-45-() 	45-Degree Table, Outside Wedge 24.5" W x 18" D	595	802	797	12
7732-60-() 	60-Degree Table, Outside Wedge 25.5" W x 18" D	595	802	797	11
7732-90-() 	90-Degree Table, Outside Wedge 36" W x 27.25" D	695	1,039	1,029	15

OPTIONS



-TAR03-L	Laminate Rotating Tablet, Right (as seated)	\$497
-TAL03-L	Laminate Rotating Tablet, Left (as seated)	\$497
-TAR03-SF	Solid Surface Rotating Tablet, Right (as seated)	\$547
-TAL03-SF	Solid Surface Rotating Tablet, Left (as seated)	\$547
-TAR03-GL	Back-Painted Glass Rotating Tablet, Right (as seated)	\$684
-TAL03-GL	Back-Painted Glass Rotating Tablet, Left (as seated)	\$684

All shipments for this series will be blanket-wrapped as standard. If cartoning is required, a 5% upcharge will be added to each product. Please contact client services for additional information.

VISOR MODULAR | Designed by David Ritch and Mark Saffell of 5d Studio

ORDERING REQUIREMENTS:

- Model number
- Base finish
- Upholstery selection
- Options, as applicable
- Layout drawing or sketch

MODEL	PRODUCT SPECIFICATIONS	FABRIC GRADES								LEATHER			
		COM	A	1	2	3	4	COL 5	6	7	8	L1	L2
7711	 <p>Public Modular Wedge Lounge Unit 31" W x 28.5" D x 31.5" H Seat: 31" W x 19" D Seat Ht: 17.5" COM: 2.25 yds. COL: 45 sq. ft. 34 lbs.</p>	1,121	1,211	1,274	1,310	1,373	1,439	1,499	1,562	1,621	1,686	1,979	2,192
7712	 <p>Public Modular Wedge Love Seat 52.5" W x 28.5" D x 31.5" H Seat: 52.5" W x 19" D Seat Ht: 17.5" COM: 3.5 yds. COL: 70 sq. ft. 48 lbs.</p>	1,597	1,737	1,835	1,891	1,989	2,091	2,185	2,283	2,374	2,476	2,931	3,263

OPTIONS



-PF02	Premium Metal Base Finish	\$80	-TAR03-L	Laminate Rotating Tablet, Right (as seated)	\$497
-GC10	Ganging Connector	\$50	-TAL03-L	Laminate Rotating Tablet, Left (as seated)	\$497
-NS04	Non-Skid Glides	\$42	-TAR03-SF	Solid Surface Rotating Tablet, Right (as seated)	\$547
-MB01	Moisture Barrier (lounge, seat only)	\$52	-TAL03-SF	Solid Surface Rotating Tablet, Left (as seated)	\$547
-MB02	Moisture Barrier (love seat, seat only)	\$73	-TAR03-GL	Back-Painted Glass Rotating Tablet, Right (as seated)	\$684
			-TAL03-GL	Back-Painted Glass Rotating Tablet, Left (as seated)	\$684

All shipments for this series will be blanket-wrapped as standard. If cartoning is required, a 5% upcharge will be added to each product. Please contact client services for additional information.

VISOR MODULAR | Designed by David Ritch and Mark Saffell of 5d Studio

ORDERING REQUIREMENTS:

- Model number
- Base finish
- Upholstery selection
- Options, as applicable
- Layout drawing or sketch

MODEL	PRODUCT SPECIFICATIONS	FABRIC GRADES										LEATHER	
		COM	A	1	2	3	4	COL 5	6	7	8	L1	L2
7711-SP 	Semi-Private Modular Wedge Lounge Unit 33.5" W x 30.25" D x 47.5" H Seat: 31.25" W x 19" D Seat Ht: 17.5" COM: 4.75 yds. COL: 95 sq. ft. 58 lbs.	1,777	1,967	2,100	2,176	2,309	2,447	2,575	2,708	2,832	2,970	3,587	4,038
XXXX-XX-CW	Privacy Panel Contrasting Welt COM: 1 yd. COL: n/a	155	195	223	239	267	296	323	351	377	406	n/a	n/a
7712-SP 	Semi-Private Modular Wedge Love Seat 55" W x 30.25" D x 47.5" H Seat: 52.5" W x 19" D Seat Ht: 17.5" COM: 6.5 yds. COL: 130 sq. ft. 71 lbs.	2,374	2,634	2,816	2,920	3,102	3,291	3,466	3,648	3,817	4,006	4,851	5,468
XXXX-XX-CW	Privacy Panel Contrasting Welt COM: 1 yd. COL: n/a	212	252	280	296	324	353	380	408	434	463	n/a	n/a

OPTIONS



-PF02	Premium Metal Base Finish	\$80	-TAR03-L	Laminate Rotating Tablet, Right (as seated)	\$497
-GC10	Ganging Connector	\$50	-TAL03-L	Laminate Rotating Tablet, Left (as seated)	\$497
-NS04	Non-Skid Glides	\$42	-TAR03-SF	Solid Surface Rotating Tablet, Right (as seated)	\$547
-MB01	Moisture Barrier (lounge, seat only)	\$52	-TAL03-SF	Solid Surface Rotating Tablet, Left (as seated)	\$547
-MB02	Moisture Barrier (love seat, seat only)	\$73	-TAR03-GL	Back-Painted Glass Rotating Tablet, Right (as seated)	\$684
			-TAL03-GL	Back-Painted Glass Rotating Tablet, Left (as seated)	\$684

All shipments for this series will be blanket-wrapped as standard. If cartoning is required, a 5% upcharge will be added to each product. Please contact client services for additional information.

VISOR MODULAR | Designed by David Ritch and Mark Saffell of 5d Studio

ORDERING REQUIREMENTS:

- Model number
- Top finish
- Edge finish
- Options, as applicable
- Layout drawing or sketch

MODEL	PRODUCT SPECIFICATIONS	LAMINATE TOP (-L)	SOLID SURFACE TOP (-SF)	BACK-PAINTED GLASS TOP (-GL)	WEIGHT
7740-15-() 	15" Wide Straight Table 15" W x 14" D	519	623	597	6
7740-20-() 	20" Wide Straight Table 20" W x 14" D	537	675	621	7

OPTIONS

-TAR03-L	Laminate Rotating Tablet, Right (as seated)	\$497	-TAR03-GL	Back-Painted Glass Rotating Tablet, Right (as seated)	\$684
-TAC03-L	Laminate Rotating Tablet, Center	\$497	-TAC03-GL	Back-Painted Glass Rotating Tablet, Center	\$684
-TAL03-L	Laminate Rotating Tablet, Left (as seated)	\$497	-TAL03-GL	Back-Painted Glass Rotating Tablet, Left (as seated)	\$684
-TAR03-SF	Solid Surface Rotating Tablet, Right (as seated)	\$547			
-TAC03-SF	Solid Surface Rotating Tablet, Center	\$547			
-TAL03-SF	Solid Surface Rotating Tablet, Left (as seated)	\$547			

All shipments for this series will be blanket-wrapped as standard. If cartoning is required, a 5% upcharge will be added to each product. Please contact client services for additional information.

VISOR MODULAR | Designed by David Ritch and Mark Saffell of 5d Studio

ORDERING REQUIREMENTS:

- Model number
- Top finish
- Edge finish
- Options, as applicable
- Layout drawing or sketch

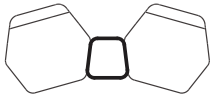
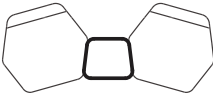
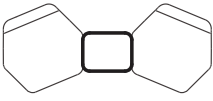
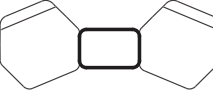
MODEL	PRODUCT SPECIFICATIONS	LAMINATE TOP (-L)	SOLID SURFACE TOP (-SF)	BACK-PAINTED GLASS TOP (-GL)	WEIGHT
7741-30-() 	30-Degree Narrow Table 14" W x 14" D	523	609	606	6
7741-31-() 	30-Degree Wide Table 17.25" W x 14" D	530	634	626	8
7741-45-() 	45-Degree Narrow Table 18" W x 14" D	545	649	630	10
7741-46-() 	45-Degree Wide Table 22" W x 14" D	572	710	658	12

OPTIONS

-TAR03-L	Laminate Rotating Tablet, Right (as seated)	\$497	-TAR03-GL	Back-Painted Glass Rotating Tablet, Right (as seated)	\$684
-TAC03-L	Laminate Rotating Tablet, Center	\$497	-TAC03-GL	Back-Painted Glass Rotating Tablet, Center	\$684
-TAL03-L	Laminate Rotating Tablet, Left (as seated)	\$497	-TAL03-GL	Back-Painted Glass Rotating Tablet, Left (as seated)	\$684
-TAR03-SF	Solid Surface Rotating Tablet, Right (as seated)	\$547			
-TAC03-SF	Solid Surface Rotating Tablet, Center	\$547			
-TAL03-SF	Solid Surface Rotating Tablet, Left (as seated)	\$547			



Please Note That Tablet Placement on 45-Degree Wide Table Must be Specified as Left or Right (Center Placement Not Available).

All shipments for this series will be blanket-wrapped as standard. If cartoning is required, a 5% upcharge will be added to each product. Please contact client services for additional information.

VISOR MODULAR | Designed by David Ritch and Mark Saffell of 5d Studio

ORDERING REQUIREMENTS:

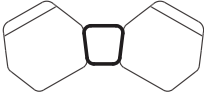
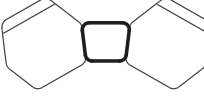
- Model number
- Top finish
- Edge finish
- Options, as applicable
- Layout drawing or sketch

MODEL	PRODUCT SPECIFICATIONS	LAMINATE TOP (-L)	SOLID SURFACE TOP (-SF)	BACK-PAINTED GLASS TOP (-GL)	WEIGHT
7741-60-() 	60-Degree Narrow Table 14" W x 14" D	523	609	606	6
7741-61-() 	60-Degree Wide Table 17.25" W x 14" D	530	634	626	8
7741-90-() 	90-Degree Narrow Table 15" W x 14" D	519	623	597	6
7741-91-() 	90-Degree Wide Table 20" W x 14" D	537	675	621	7

OPTIONS

-TAR03-L	Laminate Rotating Tablet, Right (as seated)	\$497	-TAR03-GL	Back-Painted Glass Rotating Tablet, Right (as seated)	\$684
-TAC03-L	Laminate Rotating Tablet, Center	\$497	-TAC03-GL	Back-Painted Glass Rotating Tablet, Center	\$684
-TAL03-L	Laminate Rotating Tablet, Left (as seated)	\$497	-TAL03-GL	Back-Painted Glass Rotating Tablet, Left (as seated)	\$684
-TAR03-SF	Solid Surface Rotating Tablet, Right (as seated)	\$547			
-TAC03-SF	Solid Surface Rotating Tablet, Center	\$547			
-TAL03-SF	Solid Surface Rotating Tablet, Left (as seated)	\$547			

Please Note That Tablet Placement on 90-Degree Narrow Table is Centered (Left/Right Placement Not Available).

All shipments for this series will be blanket-wrapped as standard. If cartoning is required, a 5% upcharge will be added to each product. Please contact client services for additional information.

VISOR MODULAR - CONFIGURATION & ORDERING EXAMPLES

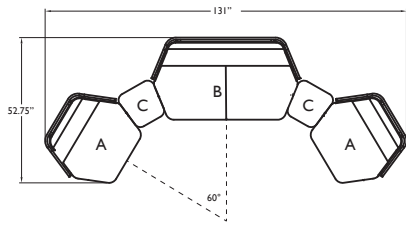

Qty	Model #	Description	COM List	Key
2	7711-SP	Semi-Private Modular Wedge Lounge Unit (\$1,777 List each)	\$3,554	A
2	7741-60-L	60-Degree Narrow Connecting Table, Laminate Top (\$523 List each)	\$1,046	C
1	7712-SP	Semi-Private Modular Wedge Love Seat	\$2,374	B
			\$6,974	

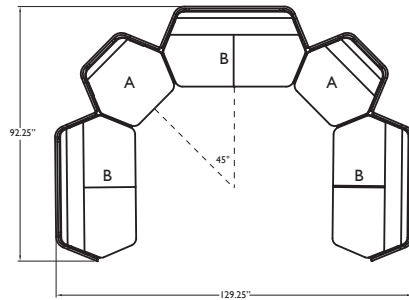

Qty	Model #	Description	COM List	Key
3	7712-SP	Semi-Private Modular Wedge Love Seat (\$2,374 List each)	\$7,122	B
2	7711-SP	Semi-Private Modular Wedge Lounge Unit (\$1,777 List each)	\$3,554	A
			\$10,676	

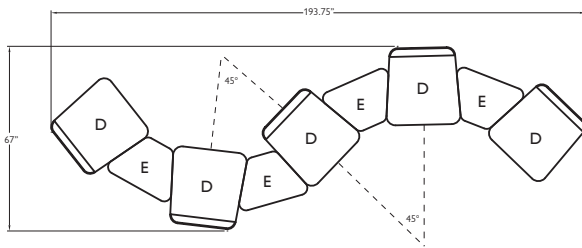

Qty	Model #	Description	COM List	Key
5	7701-M	Public Modular Lounge Unit (\$1,082 List each)	\$5,410	D
4	7731-45-L	45-Degree Connecting Table, Inside Wedge, Laminate Top (\$595 List each)	\$2,380	E
			\$7,790	

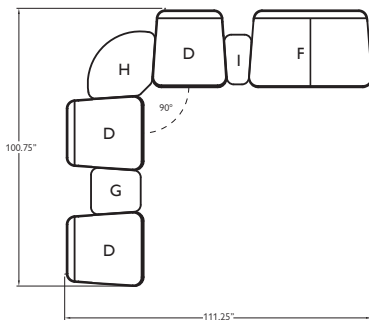

Qty	Model #	Description	COM List	Key
3	7701-M	Public Modular Lounge Unit (\$1,082 List each)	\$3,246	D
1	7730-15-L	15-Inch Wide Straight Connecting Table, Laminate Top	\$571	G
1	7731-90-L	90-Degree Connecting Table, Inside Wedge, Laminate Top	\$673	H
1	7730-8-L	8-Inch Wide Straight Connecting Table, Laminate Top	\$530	I
1	7702-M	Public Modular Love Seat	\$1,560	F
			\$6,580	

VISOR MODULAR | Designed by 5d Studio

UPHOLSTERY COMBINATIONS:

- For upholstery combinations, refer to the pricing below.
- When combining two COM/COV/COL fabrics, or fabrics with the same grade, add \$85 List per unit.
- When combining three or more COM/COV/COL fabrics, or fabrics with the same grade, add \$115 List per unit.
- When combining different grades of fabric, price will be based on the highest grade specified.
- Two-tone upholstery examples and yardage requirements for the most common combinations are listed below. Additional combinations available; please contact client services for yardage requirements and pricing.
- Note: Yardage amounts are based on fabric which is plain (i.e. non-directional) and a full 54" wide.
- Appropriate upholstery code must be included.



Code VS8
Model 7701
 7701-M
COM Requirement
 Back = 1.5 yds.
 Seat = 1 yd.

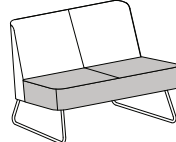

Code VS9
Model 7702
 7702-M
COM Requirement
 Back = 1.5 yds.
 Seat = 1.5 yds.



Code VS22
Model 7711
COM Requirement
 Back = 1.5 yds.
 Seat = 1 yd.

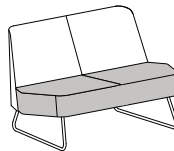

Code VS23
Model 7712
COM Requirement
 Back = 1.75 yds.
 Seat = 1.75 yds.

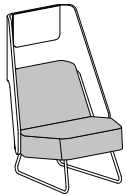

Code VS24
Model 7711-SP
COM Requirement
 Privacy Panel = 2.5 yds.
 Back & Seat = 2.5 yds.

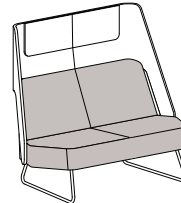

Code VS25
Model 7712-SP
COM Requirement
 Privacy Panel = 3 yds.
 Back & Seat = 3.5 yds.

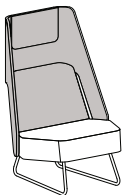

Code VS26
Model 7711-SP
COM Requirement
 Privacy Panel & Back = 4 yds.
 Seat = 1 yd.

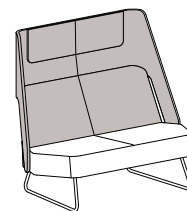

Code VS27
Model 7712-SP
COM Requirement
 Privacy Panel & Back = 4.75 yds.
 Seat = 1.75 yds.

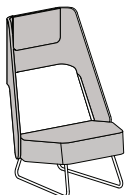

Code VS28
Model 7711-SP
COM Requirement
 Privacy Panel & Seat = 3.5 yds.
 Back = 1.5 yds.

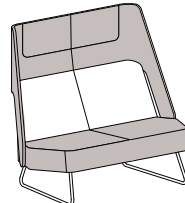

Code VS29
Model 7712-SP
COM Requirement
 Privacy Panel & Seat = 4.75 yds.
 Back = 1.75 yds.

WAKE STOOLS | Designed by Chris Panichella



SPECIFICATIONS:

- Three seated heights: 18", 25" and 30".
- Fully upholstered and sculpted plywood seat models available.
- Three wood species available: Beech, White Oak and Walnut.
- Available in all standard wood finishes. Please refer to standard finish card.
- ½" diameter steel rod frame.
- Frame available in standard and premium finishes. Please refer to listing below.
- All models stack up to 5 high.
- 350 lb. weight capacity.
- Optional clear glides for hard surface flooring.
- All dimensions are nominal.
- Refer to terms and conditions for general information regarding fabrics, finishes, warranty, freight, complete condition of sales and more.

STANDARD FRAME FINISH COLORS:

- #06 Charcoal Grey
- #90 Metallic Silver
- #91 Chrome
- #95 Satin Black

PREMIUM METAL FRAME FINISH COLORS:

- #07 Gold Shimmer
- #08 Penny
- #09 Brown Sugar
- #83 Metallic Champagne
- #94 Cotton

All shipments for this series will be blanket-wrapped as standard. If cartoning is required, a 5% upcharge will be added to each product. Please contact client services for additional information.



WAKE STOOLS | Designed by Chris Panichella



(Natural Beech, Natural Walnut and Natural White Oak wood finishes with #90 Metallic Silver and #91 Chrome frame finishes only)

ORDERING REQUIREMENTS:

- Model number
- Wood finish
- Frame finish
- Options, as applicable

MODEL	PRODUCT SPECIFICATIONS	LIST
1110-18 	18" Height Stool, Wood Seat 21.25" W x 19" D x 19.5" H Seat: 16.75" W x 16.25" D Seat Ht: 18" 13 lbs.	528
1110-25 	25" Height Stool, Wood Seat 21.25" W x 20" D x 25.5" H Seat: 16.75" W x 16.25" D Seat Ht: 25" 18 lbs.	589
1110-30 	30" Height Stool, Wood Seat 21.25" W x 20" D x 31.25" H Seat: 16.75" W x 16.25" D Seat Ht: 30" 20 lbs.	595

OPTIONS

- PF02 Premium Metal Frame Finish \$80
- CG02 Clear Glides (Set of 4) \$10

All shipments for this series will be blanket-wrapped as standard. If cartoning is required, a 5% upcharge will be added to each product. Please contact client services for additional information.

WAKE STOOLS | Designed by Chris Panichella

ORDERING REQUIREMENTS:

- Model number
- Wood finish
- Frame finish
- Upholstery selection
- Options, as applicable

MODEL	PRODUCT SPECIFICATIONS	FABRIC GRADES										LEATHER	
		COM	A	1	2	3	4	COL 5	6	7	8	L1	L2
1120-18	18" Height Stool, Wood Seat with Upholstered Cushion 21.25" W x 19" D x 19.5" H Seat: 16.75" W x 16.25" D Seat Ht: 18.5" COM: .75 yd. COL: 15 sq. ft. 14 lbs.	585	615	636	648	669	691	711	732	752	774	871	942
1120-25	25" Counter-Height Stool, Wood Seat with Upholstered Cushion 21.25" W x 20" D x 25.5" H Seat: 16.75" W x 16.25" D Seat Ht: 25" COM: .75 yd. COL: 15 sq. ft. 19 lbs.	661	691	712	724	745	767	787	808	828	850	947	1,018
1120-30	30" Bar-Height Stool, Wood Seat with Upholstered Cushion 21.25" W x 20" D x 31.25" H Seat: 16.75" W x 16.25" D Seat Ht: 30.5" COM: .75 yd. COL: 15 sq. ft. 21 lbs.	666	696	717	729	750	772	792	813	833	855	952	1,023

OPTIONS

- PF02 Premium Metal Frame Finish \$80
- CG02 Clear Glides (Set of 4) \$10

All shipments for this series will be blanket-wrapped as standard. If cartoning is required, a 5% upcharge will be added to each product. Please contact client services for additional information.

WAKE STOOLS | Designed by Chris Panichella

ORDERING REQUIREMENTS:

- Model number
- Wood finish
- Frame finish
- Upholstery selection
- Options, as applicable

MODEL	PRODUCT SPECIFICATIONS	FABRIC GRADES										LEATHER	
		COM	A	1	2	3	4	COL 5	6	7	8	L1	L2
1130-18	18" Height Stool, Fully Upholstered Seat 21.25" W x 19" D x 19.5" H Seat: 16.75" W x 16.25" D Seat Ht: 18.5" COM: .75 yd. COL: 15 sq. ft. 14 lbs.	577	607	628	640	661	683	703	724	744	766	863	934
1130-25	25" Counter-Height Stool, Fully Upholstered Seat 21.25" W x 20" D x 25.5" H Seat: 16.75" W x 16.25" D Seat Ht: 25" COM: .75 yd. COL: 15 sq. ft. 19 lbs.	636	666	687	699	720	742	762	783	803	825	922	993
1130-30	30" Bar-Height Stool, Fully Upholstered Seat 21.25" W x 20" D x 31.25" H Seat: 16.75" W x 16.25" D Seat Ht: 30.5" COM: .75 yd. COL: 15 sq. ft. 21 lbs.	642	672	693	705	726	748	768	789	809	831	928	999

OPTIONS

- PF02 Premium Metal Frame Finish \$80
- CG02 Clear Glides (Set of 4) \$10

WHIM BEAM



SPECIFICATIONS:

- 2-unit, 3-unit and 4-unit beam configurations with seating and tables.
- Seating models available in polypropylene and upholstered back and seat combinations.
- Arm and armless models available.
- Arms offered in standard and premium finishes. Refer to options below.
- Arm models feature polypropylene arm caps.
- Arm cap color will match poly back and/or seat as applicable, unless specified otherwise.
- Each seating unit features 300 lb. weight capacity.
- Beam manufactured in 14 gauge steel, available in black only.
- Leg finish available in metallic silver or black.
- Table is 18" wide x 14" deep and is offered in all standard laminate finishes. Please refer to standard finish card.
- Polypropylene available in 8 colors. Refer to options below.
- All dimensions are nominal.
- Note: model number sequence identifies location of seating and tables on beam (as facing, left to right).
- Refer to terms and conditions for general information regarding fabrics, finishes, warranty, freight, complete condition of sales and more.

STANDARD METAL ARM FINISH COLORS:

- #06 Charcoal Grey
- #90 Metallic Silver
- #91 Chrome
- #95 Satin Black

PREMIUM METAL ARM FINISH COLORS:

- #07 Gold Shimmer
- #08 Penny
- #09 Brown Sugar
- #83 Metallic Champagne
- #94 Cotton

POLYPROPYLENE COLORS:

- #115 Powder
- #116 Fog
- #117 Pitch
- #118 Sable
- #119 Candy Apple
- #120 Pistachio
- #121 Lemonade
- #122 Peacock

All shipments for this series will be blanket-wrapped as standard. If cartoning is required, a 5% upcharge will be added to each product. Please contact client services for additional information.

WHIM BEAM - 2 UNIT COMBINATIONS, POLY BACK & SEAT

ORDERING REQUIREMENTS:

- Model number
- Poly back shell and seat color
- Arm finish/poly arm cap color, as applicable
- Table finish, as applicable
- Leg finish
- Options, as applicable

MODEL	PRODUCT SPECIFICATIONS	LIST
43126-CC-BP-SP	Two Chairs on Beam, Arms Sequence: Chair, Chair Weight: 50 lbs.	1,100
43126-TC-BP-SP	One Table, One Chair on Beam, Arms Sequence: Table, Chair Weight: 50 lbs.	1,193
43126-CT-BP-SP	One Table, One Chair on Beam, Arms Sequence: Chair, Table Weight: 50 lbs.	1,193
43116-CC-BP-SP	Two Chairs on Beam, Armless Sequence: Chair, Chair Weight: 46 lbs.	1,015
43116-TC-BP-SP	One Table, One Chair on Beam, Armless Sequence: Table, Chair Weight: 46 lbs.	1,108
43116-CT-BP-SP	One Table, One Chair on Beam, Armless Sequence: Chair, Table Weight: 46 lbs.	1,108

OPTIONS

-PF02 Premium Metal Arm Finish \$80

WHIM BEAM - 2 UNIT COMBINATIONS, POLY BACK, UPHOLSTERED SEAT

ORDERING REQUIREMENTS:

- Model number
- Poly back shell color
- Arm finish/poly arm cap color, as applicable
- Upholstery selection
- Table finish, as applicable
- Leg finish
- Options, as applicable

MODEL	PRODUCT SPECIFICATIONS	FABRIC GRADES								LEATHER			
		COM	A	1	2	3	4	COL 5	6	7	8	L1	L2
43126-CC-BP-SU	Two Chairs on Beam, Arms Sequence: Chair, Chair COM: .75 yd. COL: 15 sq. ft 50 lbs.	1,218	1,248	1,269	1,281	1,302	1,324	1,344	1,365	1,385	1,407	1,504	1,575
43126-TC-BP-SU	One Table, One Chair on Beam, Arms Sequence: Table, Chair COM: .75 yd. COL: 15 sq. ft 50 lbs.	1,252	1,282	1,303	1,315	1,336	1,358	1,378	1,399	1,419	1,441	1,538	1,609
43126-CT-BP-SU	One Table, One Chair on Beam, Arms Sequence: Chair, Table COM: .75 yd. COL: 15 sq. ft 50 lbs.	1,252	1,282	1,303	1,315	1,336	1,358	1,378	1,399	1,419	1,441	1,538	1,609
43116-CC-BP-SU	Two Chairs on Beam, Armless Sequence: Chair, Chair COM: .75 yd. COL: 15 sq. ft 46 lbs.	1,133	1,163	1,184	1,196	1,217	1,239	1,259	1,280	1,300	1,322	1,419	1,490
43116-TC-BP-SU	One Table, One Chair on Beam, Armless Sequence: Table, Chair COM: .75 yd. COL: 15 sq. ft 46 lbs.	1,167	1,197	1,218	1,230	1,251	1,273	1,293	1,314	1,334	1,356	1,453	1,524
43116-CT-BP-SU	One Table, One Chair on Beam, Armless Sequence: Chair, Table COM: .75 yd. COL: 15 sq. ft 46 lbs.	1,167	1,197	1,218	1,230	1,251	1,273	1,293	1,314	1,334	1,356	1,453	1,524

OPTIONS

-PF02 Premium Metal Arm Finish \$80

All shipments for this series will be blanket-wrapped as standard. If cartoning is required, a 5% upcharge will be added to each product. Please contact client services for additional information.

WHIM BEAM - 2 UNIT COMBINATIONS, UPHOLSTERED BACK & SEAT

ORDERING REQUIREMENTS:

- Model number
- Arm finish/poly arm cap color, as applicable
- Upholstery selection
- Table finish, as applicable
- Leg finish
- Options, as applicable

MODEL	PRODUCT SPECIFICATIONS	FABRIC GRADES								LEATHER			
		COM	A	1	2	3	4	COL 5	6	7	8	L1	L2
43126-CC-BU-SU	Two Chairs on Beam, Arms Sequence: Chair, Chair COM: 2 yds. COL: 25 sq. ft 50 lbs.	1,308	1,388	1,444	1,476	1,532	1,590	1,644	1,700	1,752	1,810	2,070	2,260
43126-TC-BU-SU	One Table, One Chair on Beam, Arms Sequence: Table, Chair COM: 1.25 yds. COL: 25 sq. ft 50 lbs.	1,297	1,347	1,382	1,402	1,437	1,474	1,507	1,542	1,575	1,611	1,774	1,892
43126-CT-BU-SU	One Table, One Chair on Beam, Arms Sequence: Chair, Table COM: 1.25 yds. COL: 25 sq. ft 50 lbs.	1,297	1,347	1,382	1,402	1,437	1,474	1,507	1,542	1,575	1,611	1,774	1,892
43116-CC-BU-SU	Two Chairs on Beam, Armless Sequence: Chair, Chair COM: 2 yds. COL: 25 sq. ft 46 lbs.	1,223	1,303	1,359	1,391	1,447	1,505	1,559	1,615	1,667	1,725	1,985	2,175
43116-TC-BU-SU	One Table, One Chair on Beam, Armless Sequence: Table, Chair COM: 1.25 yds. COL: 25 sq. ft 46 lbs.	1,212	1,262	1,297	1,317	1,352	1,389	1,422	1,457	1,490	1,526	1,689	1,807
43116-CT-BU-SU	One Table, One Chair on Beam, Armless Sequence: Chair, Table COM: 1.25 yds. COL: 25 sq. ft 46 lbs.	1,212	1,262	1,297	1,317	1,352	1,389	1,422	1,457	1,490	1,526	1,689	1,807

OPTIONS

-PF02 Premium Metal Arm Finish \$80

All shipments for this series will be blanket-wrapped as standard. If cartoning is required, a 5% upcharge will be added to each product. Please contact client services for additional information.

WHIM BEAM - 3 UNIT COMBINATIONS, POLY BACK & SEAT

ORDERING REQUIREMENTS:

- Model number
- Poly back shell and seat color
- Arm finish/poly arm cap color, as applicable
- Table finish, as applicable
- Leg finish
- Options, as applicable

MODEL	PRODUCT SPECIFICATIONS	LIST
43126-CCC-BP-SP	Three Chairs on Beam, Arms Sequence: Chair, Chair, Chair Weight: 65 lbs.	1,593
43126-TCC-BP-SP	One Table, Two Chairs on Beam, Arms Sequence: Table, Chair, Chair Weight: 65 lbs.	1,686
43126-CTC-BP-SP	One Table, Two Chairs on Beam, Arms Sequence: Chair, Table, Chair Weight: 65 lbs.	1,686
43126-CCT-BP-SP	One Table, Two Chairs on Beam, Arms Sequence: Chair, Chair, Table Weight: 65 lbs.	1,686
43116-CCC-BP-SP	Three Chairs on Beam, Armless Sequence: Chair, Chair, Chair Weight: 61 lbs.	1,453
43116-TCC-BP-SP	One Table, Two Chairs on Beam, Armless Sequence: Table, Chair, Chair Weight: 61 lbs.	1,546
43116-CTC-BP-SP	One Table, Two Chairs on Beam, Armless Sequence: Chair, Table, Chair Weight: 61 lbs.	1,546
43116-CCT-BP-SP	One Table, Two Chairs on Beam, Armless Sequence: Chair, Chair, Table Weight: 61 lbs.	1,546

OPTIONS

-PF02 Premium Metal Arm Finish \$80

WHIM BEAM - 3 UNIT COMBINATIONS, POLY BACK, UPHOLSTERED SEAT

ORDERING REQUIREMENTS:

- Model number
- Poly back shell color
- Arm finish/poly arm cap color, as applicable
- Upholstery selection
- Table finish, as applicable
- Leg finish
- Options, as applicable

MODEL	PRODUCT SPECIFICATIONS	FABRIC GRADES										LEATHER	
		COM	A	1	2	3	4	COL 5	6	7	8	L1	L2
43126-CCC-BP-SU	Three Chairs on Beam, Arms Sequence: Chair, Chair, Chair COM: 1.5 yds. COL: 30 sq. ft 65 lbs.	1,770	1,830	1,872	1,896	1,938	1,982	2,022	2,064	2,103	2,147	2,342	2,484
43126-TCC-BP-SU	One Table, Two Chairs on Beam, Arms Sequence: Table, Chair, Chair COM: .75 yd. COL: 15 sq. ft 65 lbs.	1,804	1,834	1,855	1,867	1,888	1,910	1,930	1,951	1,971	1,993	2,090	2,161
43126-CTC-BP-SU	One Table, Two Chairs on Beam, Arms Sequence: Chair, Table, Chair COM: .75 yd. COL: 15 sq. ft 65 lbs.	1,804	1,834	1,855	1,867	1,888	1,910	1,930	1,951	1,971	1,993	2,090	2,161
43126-CCT-BP-SU	One Table, Two Chairs on Beam, Arms Sequence: Chair, Chair, Table COM: .75 yd. COL: 15 sq. ft 65 lbs.	1,804	1,834	1,855	1,867	1,888	1,910	1,930	1,951	1,971	1,993	2,090	2,161
43116-CCC-BP-SU	Three Chairs on Beam, Armless Sequence: Chair, Chair, Chair COM: 1.5 yds. COL: 30 sq. ft. 61 lbs.	1,630	1,690	1,732	1,756	1,798	1,842	1,882	1,924	1,963	2,007	2,202	2,344
43116-TCC-BP-SU	One Table, Two Chairs on Beam, Armless Sequence: Table, Chair, Chair COM: .75 yd. COL: 15 sq. ft. 61 lbs.	1,664	1,694	1,715	1,727	1,748	1,770	1,790	1,811	1,831	1,853	1,950	2,021
43116-CTC-BP-SU	One Table, Two Chairs on Beam, Armless Sequence: Chair, Table, Chair COM: .75 yd. COL: 15 sq. ft. 61 lbs.	1,664	1,694	1,715	1,727	1,748	1,770	1,790	1,811	1,831	1,853	1,950	2,021
43116-CCT-BP-SU	One Table, Two Chairs on Beam, Armless Sequence: Chair, Chair, Table COM: .75 yd. COL: 15 sq. ft. 61 lbs.	1,664	1,694	1,715	1,727	1,748	1,770	1,790	1,811	1,831	1,853	1,950	2,021

OPTIONS

-PF02 Premium Metal Arm Finish \$80

All shipments for this series will be blanket-wrapped as standard. If cartoning is required, a 5% upcharge will be added to each product. Please contact client services for additional information.

WHIM BEAM - 3 UNIT COMBINATIONS, UPHOLSTERED BACK & SEAT

ORDERING REQUIREMENTS:

- Model number
- Arm finish/poly arm cap color, as applicable
- Upholstery selection
- Table finish, as applicable
- Leg finish
- Options, as applicable

MODEL	PRODUCT SPECIFICATIONS	FABRIC GRADES										LEATHER	
		COM	A	1	2	3	4	COL 5	6	7	8	L1	L2
43126-CCC-BU-SU	Three Chairs on Beam, Arms Sequence: Chair, Chair, Chair COM: 3.25 yds. COL: 65 sq. ft 65 lbs.	1,905	2,035	2,126	2,178	2,269	2,364	2,451	2,542	2,627	2,721	3,144	3,452
43126-TCC-BU-SU	One Table, Two Chairs on Beam, Arms Sequence: Table, Chair, Chair COM: 2 yds. COL: 40 sq. ft 65 lbs.	1,894	1,974	2,030	2,062	2,118	2,176	2,230	2,286	2,338	2,396	2,656	2,846
43126-CTC-BU-SU	One Table, Two Chairs on Beam, Arms Sequence: Chair, Table, Chair COM: 2 yds. COL: 40 sq. ft 65 lbs.	1,894	1,974	2,030	2,062	2,118	2,176	2,230	2,286	2,338	2,396	2,656	2,846
43126-CCT-BU-SU	One Table, Two Chairs on Beam, Arms Sequence: Chair, Chair, Table COM: 2 yds. COL: 40 sq. ft 65 lbs.	1,894	1,974	2,030	2,062	2,118	2,176	2,230	2,286	2,338	2,396	2,656	2,846
43116-CCC-BU-SU	Three Chairs on Beam, Armless Sequence: Chair, Chair, Chair COM: 3.25 yds. COL: 65 sq. ft 61 lbs.	1,765	1,895	1,986	2,038	2,129	2,224	2,311	2,402	2,487	2,581	3,004	3,312
43116-TCC-BU-SU	One Table, Two Chairs on Beam, Armless Sequence: Table, Chair, Chair COM: 2 yds. COL: 40 sq. ft 61 lbs.	1,754	1,834	1,890	1,922	1,978	2,036	2,090	2,146	2,198	2,256	2,516	2,706
43116-CTC-BU-SU	One Table, Two Chairs on Beam, Armless Sequence: Chair, Table, Chair COM: 2 yds. COL: 40 sq. ft 61 lbs.	1,754	1,834	1,890	1,922	1,978	2,036	2,090	2,146	2,198	2,256	2,516	2,706
43116-CCT-BU-SU	One Table, Two Chairs on Beam, Armless Sequence: Chair, Chair, Table COM: 2 yds. COL: 40 sq. ft 61 lbs.	1,754	1,834	1,890	1,922	1,978	2,036	2,090	2,146	2,198	2,256	2,516	2,706

OPTIONS

-PF02 Premium Metal Arm Finish \$80

All shipments for this series will be blanket-wrapped as standard. If cartoning is required, a 5% upcharge will be added to each product. Please contact client services for additional information.

WHIM BEAM - 4 UNIT COMBINATIONS, POLY BACK & SEAT

ORDERING REQUIREMENTS:

- Model number
- Poly back shell and seat color
- Arm finish/poly arm cap color, as applicable
- Table finish, as applicable
- Leg finish
- Options, as applicable

MODEL	PRODUCT SPECIFICATIONS	LIST
43126-CCCC-BP-SP	Four Chairs on Beam, Arms Sequence: Chair, Chair, Chair, Chair Weight: 80 lbs.	2,085
43126-TCCC-BP-SP	One Table, Three Chairs on Beam, Arms Sequence: Table, Chair, Chair, Chair Weight: 80 lbs.	2,178
43126-CCCT-BP-SP	One Table, Three Chairs on Beam, Arms Sequence: Chair, Chair, Chair, Table Weight: 80 lbs.	2,178
43126-CTCC-BP-SP	One Table, Three Chairs on Beam, Arms Sequence: Chair, Table, Chair, Chair Weight: 80 lbs.	2,178
43126-CCTC-BP-SP	One Table, Three Chairs on Beam, Arms Sequence: Chair, Chair, Table, Chair Weight: 80 lbs.	2,178
43126-TCTC-BP-SP	Two Tables, Two Chairs on Beam, Arms Sequence: Table, Chair, Table, Chair Weight: 80 lbs.	2,271
43126-CTCT-BP-SP	Two Tables, Two Chairs on Beam, Arms Sequence: Chair, Table, Chair, Table Weight: 80 lbs.	2,271
43126-TCCT-BP-SP	Two Tables, Two Chairs on Beam, Arms Sequence: Table, Chair, Chair, Table Weight: 80 lbs.	2,271

OPTIONS

-PF02 Premium Metal Arm Finish \$80

WHIM BEAM - 4 UNIT COMBINATIONS, POLY BACK & SEAT

ORDERING REQUIREMENTS:

- Model number
- Poly back shell and seat color
- Arm finish/poly arm cap color, as applicable
- Table finish, as applicable
- Leg finish

MODEL	PRODUCT SPECIFICATIONS	LIST
43116-CCCC-BP-SP	Four Chairs on Beam, Armless Sequence: Chair, Chair, Chair, Chair Weight: 76 lbs.	1,899
43116-TCCC-BP-SP	One Table, Three Chairs on Beam, Armless Sequence: Table, Chair, Chair, Chair Weight: 76 lbs.	1,992
43116-CCCT-BP-SP	One Table, Three Chairs on Beam, Armless Sequence: Chair, Chair, Chair, Table Weight: 76 lbs.	1,992
43116-CTCC-BP-SP	One Table, Three Chairs on Beam, Armless Sequence: Chair, Table, Chair, Chair Weight: 76 lbs.	1,992
43116-CCTC-BP-SP	One Table, Three Chairs on Beam, Armless Sequence: Chair, Chair, Table, Chair Weight: 76 lbs.	1,992
43116-TCTC-BP-SP	Two Tables, Two Chairs on Beam, Armless Sequence: Table, Chair, Table Chair Weight: 76 lbs.	2,085
43116-CTCT-BP-SP	Two Tables, Two Chairs on Beam, Armless Sequence: Chair, Table, Chair, Table Weight: 76 lbs.	2,085
43116-TCCT-BP-SP	Two Tables, Two Chairs on Beam, Armless Sequence: Table, Chair, Chair, Table Weight: 76 lbs.	2,085

All shipments for this series will be blanket-wrapped as standard. If cartoning is required, a 5% upcharge will be added to each product. Please contact client services for additional information.

WHIM BEAM - 4 UNIT COMBINATIONS, POLY BACK, UPHOLSTERED SEAT

ORDERING REQUIREMENTS:

- Model number
- Poly back shell color
- Arm finish/poly arm cap color, as applicable
- Upholstery selection
- Table finish, as applicable
- Leg finish
- Options, as applicable

MODEL	PRODUCT SPECIFICATIONS	FABRIC GRADES										LEATHER	
		COM	A	1	2	3	4	COL 5	6	7	8	L1	L2
43126-CCCC-BP-SU	Four Chairs on Beam, Arms Sequence: Chair, Chair, Chair, Chair COM: 1.5 yds. COL: 30 sq. ft 80 lbs.	2,321	2,381	2,423	2,447	2,489	2,533	2,573	2,615	2,654	2,698	2,893	3,035
43126-TCCC-BP-SU	One Table, Three Chairs on Beam, Arms Sequence: Table, Chair, Chair, Chair COM: 1.5 yds. COL: 30 sq. ft 80 lbs.	2,355	2,415	2,457	2,481	2,523	2,567	2,607	2,649	2,688	2,732	2,927	3,069
43126-CCCT-BP-SU	One Table, Three Chairs on Beam, Arms Sequence: Chair, Chair, Chair, Table COM: 1.5 yds. COL: 30 sq. ft 80 lbs..	2,355	2,415	2,457	2,481	2,523	2,567	2,607	2,649	2,688	2,732	2,927	3,069
43126-CTCC-BP-SU	One Table, Three Chairs on Beam, Arms Sequence: Chair, Table, Chair, Chair COM: 1.5 yds. COL: 30 sq. ft 80 lbs.	2,355	2,415	2,457	2,481	2,523	2,567	2,607	2,649	2,688	2,732	2,927	3,069
43126-CCTC-BP-SU	One Table, Three Chairs on Beam, Arms Sequence: Chair, Chair, Table, Chair COM: 1.5 yds. COL: 30 sq. ft 80 lbs.	2,355	2,415	2,457	2,481	2,523	2,567	2,607	2,649	2,688	2,732	2,927	3,069
43126-TCTC-BP-SU	Two Tables, Two Chairs on Beam, Arms Sequence: Table, Chair, Table, Chair COM: .75 yd. COL: 15 sq. ft 80 lbs.	2,389	2,419	2,440	2,452	2,473	2,495	2,515	2,536	2,556	2,578	2,675	2,746
43126-CTCT-BP-SU	Two Tables, Two Chairs on Beam, Arms Sequence: Chair, Table, Chair, Table COM: .75 yd. COL: 15 sq. ft 80 lbs.	2,389	2,419	2,440	2,452	2,473	2,495	2,515	2,536	2,556	2,578	2,675	2,746
43126-TCCT-BP-SU	Two Tables, Two Chairs on Beam, Arms Sequence: Table, Chair, Chair, Table COM: .75 yd. COL: 15 sq. ft 80 lbs.	2,389	2,419	2,440	2,452	2,473	2,495	2,515	2,536	2,556	2,578	2,675	2,746

OPTIONS

-PF02 Premium Metal Arm Finish \$80

WHIM BEAM - 4 UNIT COMBINATIONS, POLY BACK, UPHOLSTERED SEAT

ORDERING REQUIREMENTS:

- Model number
- Poly back shell color
- Arm finish/poly arm cap color, as applicable
- Upholstery selection
- Table finish, as applicable
- Leg finish

MODEL	PRODUCT SPECIFICATIONS	FABRIC GRADES										LEATHER	
		COM	A	1	2	3	4	COL 5	6	7	8	L1	L2
43116-CCCC-BP-SU	Four Chairs on Beam, Armless Sequence: Chair, Chair, Chair, Chair COM: 1.5 yds. COL: 30 sq. ft 76 lbs.	2,135	2,195	2,237	2,261	2,303	2,347	2,387	2,429	2,468	2,512	2,707	2,849
43116-TCCC-BP-SU	One Table, Three Chairs on Beam, Armless Sequence: Table, Chair, Chair, Chair COM: 1.5 yds. COL: 30 sq. ft 76 lbs.	2,169	2,229	2,271	2,295	2,337	2,381	2,421	2,463	2,502	2,546	2,741	2,883
43116-CCCT-BP-SU	One Table, Three Chairs on Beam, Armless Sequence: Chair, Chair, Chair, Table COM: 1.5 yds. COL: 30 sq. ft 76 lbs.	2,169	2,229	2,271	2,295	2,337	2,381	2,421	2,463	2,502	2,546	2,741	2,883
43116-CTCC-BP-SU	One Table, Three Chairs on Beam, Armless Sequence: Chair, Table, Chair, Chair COM: 1.5 yds. COL: 30 sq. ft 76 lbs.	2,169	2,229	2,271	2,295	2,337	2,381	2,421	2,463	2,502	2,546	2,741	2,883
43116-CCTC-BP-SU	One Table, Three Chairs on Beam, Armless Sequence: Chair, Chair, Table, Chair COM: 1.5 yds. COL: 30 sq. ft 76 lbs.	2,169	2,229	2,271	2,295	2,337	2,381	2,421	2,463	2,502	2,546	2,741	2,883
43116-TCTC-BP-SU	Two Tables, Two Chairs on Beam, Armless Sequence: Table, Chair, Table Chair COM: .75 yd. COL: 15 sq. ft 76 lbs.	2,203	2,233	2,254	2,266	2,287	2,309	2,329	2,350	2,370	2,392	2,489	2,560
43116-CTCT-BP-SU	Two Tables, Two Chairs on Beam, Armless Sequence: Chair, Table, Chair, Table COM: .75 yd. COL: 15 sq. ft 76 lbs.	2,203	2,233	2,254	2,266	2,287	2,309	2,329	2,350	2,370	2,392	2,489	2,560
43116-TCCT-BP-SU	Two Tables, Two Chairs on Beam, Armless Sequence: Table, Chair, Chair, Table COM: .75 yd. COL: 15 sq. ft 76 lbs.	2,203	2,233	2,254	2,266	2,287	2,309	2,329	2,350	2,370	2,392	2,489	2,560

WHIM BEAM - 4 UNIT COMBINATIONS, UPHOLSTERED BACK & SEAT

ORDERING REQUIREMENTS:

- Model number
- Arm finish/poly arm cap color, as applicable
- Upholstery selection
- Table finish, as applicable
- Leg finish
- Options, as applicable

MODEL	PRODUCT SPECIFICATIONS	FABRIC GRADES								LEATHER			
		COM	A	1	2	3	4	COL 5	6	7	8	L1	L2
43126-CCCC-BU-SU	Four Chairs on Beam, Arms Sequence: Chair, Chair, Chair, Chair COM: 4 yds. COL: 80 sq. ft 80 lbs.	2,501	2,661	2,773	2,837	2,949	3,065	3,173	3,285	3,389	3,505	4,025	4,405
43126-TCCC-BU-SU	One Table, Three Chairs on Beam, Arms Sequence: Table, Chair, Chair, Chair COM: 3.25 yds. COL: 65 sq. ft 80 lbs.	2,490	2,620	2,711	2,763	2,854	2,949	3,036	3,127	3,212	3,306	3,729	4,037
43126-CCCT-BU-SU	One Table, Three Chairs on Beam, Arms Sequence: Chair, Chair, Chair, Table COM: 3.25 yds. COL: 65 sq. ft 80 lbs.	2,490	2,620	2,711	2,763	2,854	2,949	3,036	3,127	3,212	3,306	3,729	4,037
43126-CTCC-BU-SU	One Table, Three Chairs on Beam, Arms Sequence: Chair, Table, Chair, Chair COM: 3.25 yds. COL: 65 sq. ft 80 lbs.	2,490	2,620	2,711	2,763	2,854	2,949	3,036	3,127	3,212	3,306	3,729	4,037
43126-CCTC-BU-SU	One Table, Three Chairs on Beam, Arms Sequence: Chair, Chair, Table, Chair COM: 3.25 yds. COL: 65 sq. ft 80 lbs.	2,490	2,620	2,711	2,763	2,854	2,949	3,036	3,127	3,212	3,306	3,729	4,037
43126-TCTC-BU-SU	Two Tables, Two Chairs on Beam, Arms Sequence: Table, Chair, Table, Chair COM: 2 yds. COL: 40 sq. ft 80 lbs.	2,479	2,559	2,615	2,647	2,703	2,761	2,815	2,871	2,923	2,981	3,241	3,431
43126-CTCT-BU-SU	Two Tables, Two Chairs on Beam, Arms Sequence: Chair, Table, Chair, Table COM: 2 yds. COL: 15 sq. ft 80 lbs.	2,479	2,559	2,615	2,647	2,703	2,761	2,815	2,871	2,923	2,981	3,241	3,431
43126-TCCT-BU-SU	Two Tables, Two Chairs on Beam, Arms Sequence: Table, Chair, Chair, Table COM: 2 yds. COL: 40 sq. ft 80 lbs.	2,479	2,559	2,615	2,647	2,703	2,761	2,815	2,871	2,923	2,981	3,241	3,431

OPTIONS

-PF02 Premium Metal Arm Finish \$80

WHIM BEAM - 4 UNIT COMBINATIONS, UPHOLSTERED BACK & SEAT

ORDERING REQUIREMENTS:

- Model number
- Arm finish/poly arm cap color, as applicable
- Upholstery selection
- Table finish, as applicable
- Leg finish

MODEL	PRODUCT SPECIFICATIONS	FABRIC GRADES										LEATHER	
		COM	A	1	2	3	4	COL 5	6	7	8	L1	L2
43116-CCCC-BU-SU	Four Chairs on Beam, Armless Sequence: Chair, Chair, Chair, Chair COM: 4 yds. COL: 80 sq. ft 76 lbs.	2,315	2,475	2,587	2,651	2,763	2,879	2,987	3,099	3,203	3,319	3,839	4,219
43116-TCCC-BU-SU	One Table, Three Chairs on Beam, Armless Sequence: Table, Chair, Chair, Chair COM: 3.25 yds. COL: 65 sq. ft 76 lbs.	2,304	2,434	2,525	2,577	2,668	2,763	2,850	2,941	3,026	3,120	3,543	3,851
43116-CCCT-BU-SU	One Table, Three Chairs on Beam, Armless Sequence: Chair, Chair, Chair, Table COM: 3.25 yds. COL: 65 sq. ft 76 lbs.	2,304	2,434	2,525	2,577	2,668	2,763	2,850	2,941	3,026	3,120	3,543	3,851
43116-CTCC-BU-SU	One Table, Three Chairs on Beam, Armless Sequence: Chair, Table, Chair, Chair COM: 3.25 yds. COL: 65 sq. ft 76 lbs.	2,304	2,434	2,525	2,577	2,668	2,763	2,850	2,941	3,026	3,120	3,543	3,851
43116-CCTC-BU-SU	One Table, Three Chairs on Beam, Armless Sequence: Chair, Chair, Table, Chair COM: 3.25 yds. COL: 65 sq. ft 76 lbs.	2,304	2,434	2,525	2,577	2,668	2,763	2,850	2,941	3,026	3,120	3,543	3,851
43116-TCTC-BU-SU	Two Tables, Two Chairs on Beam, Armless Sequence: Table, Chair, Table Chair COM: 2 yds. COL: 40 sq. ft 76 lbs.	2,293	2,373	2,429	2,461	2,517	2,575	2,629	2,685	2,737	2,795	3,055	3,245
43116-CTCT-BU-SU	Two Tables, Two Chairs on Beam, Armless Sequence: Chair, Table, Chair, Table COM: 2 yds. COL: 40 sq. ft 76 lbs.	2,293	2,373	2,429	2,461	2,517	2,575	2,629	2,685	2,737	2,795	3,055	3,245
43116-TCCT-BU-SU	Two Tables, Two Chairs on Beam, Armless Sequence: Table, Chair, Chair, Table COM: 2 yds. COL: 40 sq. ft 76 lbs.	2,293	2,373	2,429	2,461	2,517	2,575	2,629	2,685	2,737	2,795	3,055	3,245

WHIM GUEST



SPECIFICATIONS:

- Upholstered, polypropylene and mesh suspension back models available.
- Please refer to listing below for polypropylene and mesh suspension colors.
- Arm and armless models available with glides or casters.
- Arm models feature polypropylene arm caps.
- Arm cap color will match poly back and seat unless specified otherwise.
- Tubular steel frame.
- Frame available in standard and premium finishes. Please refer to listing below.
- Arm models stack up to 8-high.
- Armless models stack up to 8-high standing or 14-high on dolly.
- 300 lb. weight capacity.
- All dimensions are nominal.
- Refer to terms and conditions for general information regarding fabrics, finishes, warranty, freight, complete condition of sales and more.

STANDARD METAL ARM FINISH COLORS:

- #06 Charcoal Grey
- #90 Metallic Silver
- #91 Chrome
- #95 Satin Black

PREMIUM METAL ARM FINISH COLORS:

- #07 Gold Shimmer
- #08 Penny
- #09 Brown Sugar
- #83 Metallic Champagne
- #94 Cotton

POLYPROPYLENE COLORS:

- #115 Powder
- #116 Fog
- #117 Pitch
- #118 Sable
- #119 Candy Apple
- #120 Pistachio
- #121 Lemonade
- #122 Peacock

MESH SUSPENSION COLORS:

- #107 Sterling
- #109 Night
- #126 Wheat

All shipments for this series will be blanket-wrapped as standard. If cartoning is required, a 5% upcharge will be added to each product. Please contact client services for additional information.





WHIM GUEST - POLY BACK & SEAT



#90 Metallic Silver and #91 Chrome finishes only

ORDERING REQUIREMENTS:

- Model number
- Poly back shell and seat color
- Frame finish
- Options, as applicable

MODEL	PRODUCT SPECIFICATIONS	LIST
 <p>43121-BP-SP</p>	<p>Poly Back and Seat, Arms, Glides</p> <p>23.75" W x 21.75" D x 33.5" H Seat: 18" W x 17.5" D Seat Ht: 17" Arm Ht: 25.5" Weight: 17 lbs.</p>	294
 <p>43125-BP-SP</p>	<p>Poly Back and Seat, Arms, Casters</p> <p>23.75" W x 21.75" D x 33.5" H Seat: 18" W x 17.5" D Seat Ht: 17" Arm Ht: 25.5" Weight: 18 lbs.</p>	313
 <p>43111-BP-SP</p>	<p>Poly Back and Seat, Armless, Glides</p> <p>18" W x 21.75" D x 33.5" H Seat: 18" W x 17.5" D Seat Ht: 17" Weight: 13 lbs.</p>	258
 <p>43115-BP-SP</p>	<p>Poly Back and Seat, Armless, Casters</p> <p>18" W x 21.75" D x 33.5" H Seat: 18" W x 17.5" D Seat Ht: 17" Weight: 14 lbs.</p>	277

OPTIONS

- PF02 Premium Metal Frame Finish \$80
- STC02 Soft Tread Casters \$26

All shipments for this series will be blanket-wrapped as standard. If cartoning is required, a 5% upcharge will be added to each product. Please contact client services for additional information.

WHIM GUEST - POLY BACK, UPHOLSTERED SEAT

ORDERING REQUIREMENTS:

- Model number
- Poly back color
- Frame finish
- Upholstery selection
- Options, as applicable

MODEL	PRODUCT SPECIFICATIONS	FABRIC GRADES								LEATHER			
		COM	A	1	2	3	4	COL 5	6	7	8	L1	L2
43121-BP-SU	Poly Back, Upholstered Seat, Arms, Glides 23.75" W x 22.25" D x 33.5" H Seat: 18.5" W x 18" D Seat Ht: 18" Arm Ht: 25.5" COM: .75 yd. COL: 15 sq. ft. 17 lbs.	351	381	402	414	435	457	477	498	518	540	637	708
43125-BP-SU	Poly Back, Upholstered Seat, Arms, Casters 23.75" W x 22.25" D x 33.5" H Seat: 18.5" W x 18" D Seat Ht: 18" Arm Ht: 25.5" COM: .75 yd. COL: 15 sq. ft. 18 lbs.	370	400	421	433	454	476	496	517	537	559	656	727
43111-BP-SU	Poly Back, Upholstered Seat, Armless, Glides 18.5" W x 22.25" D x 33.5" H Seat: 18.5" W x 18" D Seat Ht: 18" COM: .75 yd. COL: 15 sq. ft. 13 lbs.	314	344	365	377	398	420	440	461	481	503	600	671
43115-BP-SU	Poly Back, Upholstered Seat, Armless, Casters 18.5" W x 22.25" D x 33.5" H Seat: 18.5" W x 18" D Seat Ht: 18" COM: .75 yd. COL: 15 sq. ft. 14 lbs.	333	363	384	396	417	439	459	480	500	522	619	690

OPTIONS

- PF02 Premium Metal Frame Finish \$80
- STC02 Soft Tread Casters \$26

All shipments for this series will be blanket-wrapped as standard. If cartoning is required, a 5% upcharge will be added to each product. Please contact client services for additional information.





WHIM GUEST - UPHOLSTERED BACK & SEAT



#90 Metallic Silver and #91 Chrome finishes only

ORDERING REQUIREMENTS:

- Model number
- Poly arm cap color, as applicable
- Frame finish
- Upholstery selection
- Options, as applicable

MODEL	PRODUCT SPECIFICATIONS	FABRIC GRADES								LEATHER			
		COM	A	1	2	3	4	COL 5	6	7	8	L1	L2
43121-BU-SU	Upholstered Back and Seat, Arms, Glides  23.75" W x 22.25" D x 33.5" H Seat: 18.5" W x 18" D Seat Ht: 18" Arm Ht: 25.5" COM: 1.25 yds. COL: 25 sq. ft 18 lbs.	393	443	478	498	533	570	603	638	671	707	870	988
43125-BU-SU	Upholstered Back and Seat, Arms, Casters  23.75" W x 22.25" D x 33.5" H Seat: 18.5" W x 18" D Seat Ht: 18" Arm Ht: 25.5" COM: 1.25 yds. COL: 25 sq. ft 19 lbs.	412	462	497	517	552	589	622	657	690	726	889	1,007
43111-BU-SU	Upholstered Back and Seat, Armless, Glides  18.5" W x 22.25" D x 33.5" H Seat: 18.5" W x 18" D Seat Ht: 18" COM: 1.25 yds. COL: 25 sq. ft 14 lbs.	356	406	441	461	496	533	566	601	634	670	833	951
43115-BU-SU	Upholstered Back and Seat, Armless, Casters  18.5" W x 22.25" D x 33.5" H Seat: 18.5" W x 18" D Seat Ht: 18" COM: 1.25 yds. COL: 25 sq. ft 15 lbs.	375	425	460	480	515	552	585	620	653	689	852	970

OPTIONS





- PF02 Premium Metal Frame Finish \$80
- STC02 Soft Tread Casters \$26

All shipments for this series will be blanket-wrapped as standard. If cartoning is required, a 5% upcharge will be added to each product. Please contact client services for additional information.

WHIM GUEST - MESH BACK, UPHOLSTERED SEAT

ORDERING REQUIREMENTS:

- Model number
- Mesh suspension color
- Poly back color
- Poly arm cap color, as applicable
- Frame finish
- Upholstery selection
- Options, as applicable

MODEL	PRODUCT SPECIFICATIONS	FABRIC GRADES								LEATHER			
		COM	A	1	2	3	4	COL 5	6	7	8	L1	L2
43121-BK-SU 	Mesh Back, Upholstered Seat, Arms, Glides 23.75" W x 22.25" D x 33.5" H Seat: 18.5" W x 18" D Seat Ht: 18" Arm Ht: 25.5" COM: .75 yd. COL: 15 sq. ft. 17 lbs.	380	410	431	443	464	486	506	527	547	569	666	737
43125-BK-SU 	Mesh Back, Upholstered Seat, Arms, Casters 23.75" W x 22.25" D x 33.5" H Seat: 18.5" W x 18" D Seat Ht: 18" Arm Ht: 25.5" COM: .75 yd. COL: 15 sq. ft. 18 lbs.	399	429	450	462	483	505	525	546	566	588	685	756
43111-BK-SU 	Mesh Back, Upholstered Seat, Armless, Glides 18.5" W x 22.25" D x 33.5" H Seat: 18.5" W x 18" D Seat Ht: 18" COM: .75 yd. COL: 15 sq. ft. 13 lbs.	344	374	395	407	428	450	470	491	511	533	630	701
43115-BK-SU 	Mesh Back, Upholstered Seat, Armless, Casters 18.5" W x 22.25" D x 33.5" H Seat: 18.5" W x 18" D Seat Ht: 18" COM: .75 yd. COL: 15 sq. ft. 14 lbs.	363	393	414	426	447	469	489	510	530	552	649	720

OPTIONS





- PF02 Premium Metal Frame Finish \$80
- STC02 Soft Tread Casters \$26

All shipments for this series will be blanket-wrapped as standard. If cartoning is required, a 5% upcharge will be added to each product. Please contact client services for additional information.

WHIM GUEST - MESH BACK, POLY SEAT

ORDERING REQUIREMENTS:

- Model number
- Mesh suspension color
- Poly back color
- Poly arm cap color, as applicable
- Frame finish
- Upholstery selection
- Options, as applicable

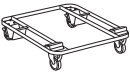
MODEL	PRODUCT SPECIFICATIONS	LIST
43121-BK-SP 	Mesh Back, Poly Seat, Arms, Glides 23.75" W x 21.75" D x 33.5" H Seat: 18" W x 17.5" D Seat Ht: 17" Arm Ht: 25.5" Weight: 17 lbs.	324
43125-BK-SP 	Mesh Back, Poly Seat, Arms, Casters 23.75" W x 21.75" D x 33.5" H Seat: 18" W x 17.5" D Seat Ht: 18" Arm Ht: 25.5" Weight: 18 lbs.	343
43111-BK-SP 	Mesh Back, Poly Seat, Armless, Glides 18" W x 21.75" D x 33.5" H Seat: 18" W x 17.5" D Seat Ht: 17" Weight: 13 lbs.	287
43115-BK-SP 	Mesh Back, Poly Seat, Armless, Casters 18" W x 21.75" D x 33.5" H Seat: 18" W x 17.5" D Seat Ht: 17.5" Weight: 14 lbs.	306
4300 	Dolly (Black Finish Only) 24" W x 30" D x 6" H 37 lbs.	427

OPTIONS

- PF02 Premium Metal Frame Finish \$80
- STC02 Soft Tread Casters \$26

All shipments for this series will be cartoned as standard. If blanket-wrapped shipping is required, please contact client services for additional information.

WHIM TASK



SPECIFICATIONS:

- Upholstered, polypropylene and mesh suspension back models with upholstered seat.
- Please refer to listing below for polypropylene and mesh suspension colors.
- Arm and armless models available.
- Arms available in standard and premium finishes. Please refer to listing below.
- Arm models feature polypropylene arm caps.
- Arm cap color will match poly back unless specified otherwise.
- Fixed back height.
- Two base options: black nylon and polished aluminum.
- 300 lb. weight capacity.
- Ships KD (knocked down).
- All dimensions are nominal.
- Refer to terms and conditions for general information regarding fabrics, finishes, warranty, freight, complete condition of sales and more.

STANDARD METAL ARM FINISH COLORS:

- #06 Charcoal Grey
- #90 Metallic Silver
- #91 Chrome
- #95 Satin Black

PREMIUM METAL ARM FINISH COLORS:

- #07 Gold Shimmer
- #08 Penny
- #09 Brown Sugar
- #83 Metallic Champagne
- #94 Cotton

POLYPROPYLENE COLORS:

- #115 Powder
- #116 Fog
- #117 Pitch
- #118 Sable
- #119 Candy Apple
- #120 Pistachio
- #121 Lemonade
- #122 Peacock

MESH SUSPENSION COLORS:

- #107 Sterling
- #109 Night
- #126 Wheat



All shipments for this series will be cartoned as standard. If blanket-wrapped shipping is required, please contact client services for additional information.

WHIM TASK - POLY BACK, UPHOLSTERED SEAT

Non-Tilt, Height Adjustable Swivel Mechanism

ORDERING REQUIREMENTS:

- Model number
- Poly back color
- Arm finish/poly arm cap color, as applicable
- Base finish
- Upholstery selection
- Options, as applicable

MODEL	PRODUCT SPECIFICATIONS	BASE FINISH	FABRIC GRADES								LEATHER			
			COM	A	1	2	3	4	COL 5	6	7	8	L1	L2
43123-BP-SU 	Poly Back, Upholstered Seat, Arms 23.75" W x 21.75" D x 31.5" - 34.5" H Seat: 18" W x 17.5" D Seat Ht: 16" - 19" Arm Ht: 27" Back: 18" W x 15" H COM: .75 yds. COL: 15 sq. ft. 24 lbs.	Black Nylon	608	638	659	671	692	714	734	755	775	797	894	965
		Polished Aluminum	687	717	738	750	771	793	813	834	854	876	973	1,044
43113-BP-SU 	Poly Back, Upholstered Seat, Armless 18.5" W x 21.75" D x 31.5" - 34.5" H Seat: 18" W x 17.5" D Seat Ht: 16" - 19" Back: 18" W x 15" H COM: .75 yds. COL: 15 sq. ft. 20 lbs.	Black Nylon	571	601	622	634	655	677	697	718	738	760	857	928
		Polished Aluminum	650	680	701	713	734	756	776	797	817	839	936	1,007

OPTIONS

-PF02	Premium Metal Arm Finish	\$80
-STC02	Soft Tread Casters	\$26
-STLC02	Soft Tread Self-Locking Casters	\$52
-GD04	Glides	\$26
-J01	Jury Base (black only)	\$150

All shipments for this series will be cartoned as standard. If blanket-wrapped shipping is required, please contact client services for additional information.

WHIM TASK - UPHOLSTERED BACK & SEAT





#90 Metallic Silver and
#91 Chrome arm finishes only

Non-Tilt, Height Adjustable Swivel Mechanism

ORDERING REQUIREMENTS:

- Model number
- Arm finish/poly arm cap color, as applicable
- Base finish
- Upholstery selection
- Options, as applicable

MODEL	PRODUCT SPECIFICATIONS	BASE FINISH	FABRIC GRADES								LEATHER			
			COM	A	1	2	3	4	COL 5	6	7	8	L1	L2
43123-BU-SU 	Upholstered Back and Seat, Arms 23.75" W x 21.75" D x 31.5" - 34.5" H Seat: 18" W x 17.5" D Seat Ht: 16" - 19" Arm Ht: 27" Back: 18" W x 15" H COM: 1.25 yds. COL: 25 sq. ft. 25 lbs.	Black Nylon	651	701	736	756	791	828	861	896	929	965	1,128	1,246
		Polished Aluminum	730	780	815	835	870	907	940	975	1,008	1,044	1,207	1,325
43113-BU-SU 	Upholstered Back and Seat, Armless 18.5" W x 21.75" D x 31.5" - 34.5" H Seat: 18" W x 17.5" D Seat Ht: 16" - 19" Back: 18" W x 15" H COM: 1.25 yds. COL: 25 sq. ft. 21 lbs.	Black Nylon	614	664	699	719	754	791	824	859	892	928	1,091	1,209
		Polished Aluminum	693	743	778	798	833	870	903	938	971	1,007	1,170	1,288

OPTIONS

-PF02	Premium Metal Arm Finish	\$80
-STC02	Soft Tread Casters	\$26
-STLC02	Soft Tread Self-Locking Casters	\$52
-GD04	Glides	\$26
-J01	Jury Base (black only)	\$150



All shipments for this series will be cartoned as standard. If blanket-wrapped shipping is required, please contact client services for additional information.

WHIM TASK - MESH BACK, UPHOLSTERED SEAT

Non-Tilt, Height Adjustable Swivel Mechanism

ORDERING REQUIREMENTS:

- Model number
- Mesh suspension color
- Poly back shell color
- Arm finish/poly arm cap color, as applicable
- Base finish
- Upholstery selection
- Options, as applicable

MODEL	PRODUCT SPECIFICATIONS	BASE FINISH	FABRIC GRADES								LEATHER			
			COM	A	1	2	3	4	COL 5	6	7	8	L1	L2
43123-BK-SU 	Mesh Back, Upholstered Seat, Arms 23.75" W x 21.75" D x 31.5" - 34.5" H Seat: 18" W x 17.5" D Seat Ht: 16" - 19" Arm Ht: 27" Back: 18" W x 15" H COM: .75 yds. COL: 15 sq. ft. 24 lbs.	Black Nylon	637	667	688	700	721	743	763	784	804	826	923	994
		Polished Aluminum	716	746	767	779	800	822	842	863	883	905	1,002	1,073
43113-BK-SU 	Mesh Back, Upholstered Seat, Armless 18.5" W x 21.75" D x 31.5" - 34.5" H Seat: 18" W x 17.5" D Seat Ht: 16" - 19" Back: 18" W x 15" H COM: .75 yds. COL: 15 sq. ft. 20 lbs.	Black Nylon	601	631	652	664	685	707	727	748	768	790	887	958
		Polished Aluminum	680	710	731	743	764	786	806	827	847	869	966	1,037

OPTIONS

-PF02	Premium Metal Arm Finish	\$80
-STC02	Soft Tread Casters	\$26
-STLC02	Soft Tread Self-Locking Casters	\$52
-GD04	Glides	\$26
-J01	Jury Base (black only)	\$150



800 585 5957 | 714 562 8200 | encoreseating.com

• An Arcadia Company •