

All shipments for this series will be blanket-wrapped as standard. For customers located in Territory 1 who require cartoning, a 5% upcharge will be added to each product. Please contact client services for additional information.

CHANCE GUEST | Designed by Francisco Romero of PhiDesign



SPECIFICATIONS:

- Fully upholstered arm and armless models.
- Fully upholstered bariatric models with enhanced seat and back size also available.
- Arms feature black finish as standard.
- Silver arm finish also available. Please specify (-SA01) after model number and add \$32 list.
- Round tubular steel frame.
- Frame available in standard and premium finishes. See below for options.
- For custom finish colors, please contact client services for pricing.
- Available with glides or on casters.
- Chairs with glides or casters stack up to 4 high standing or 5 with dolly.
- Optional ganging device available.
- If cartoning is required, chairs are packaged in units of three (3). A \$20 List carton break charge will be applied for orders with only one or two chairs.
- Guest chairs feature 300 lb. weight capacity.
- Bariatric models feature 500 lb. weight capacity.
- Refer to terms and conditions for general information regarding fabrics, finishes, warranty, freight, complete condition of sales and more.

STANDARD METAL FRAME FINISH COLORS:

- 0405 Charcoal Grey
- 0535 Metallic Silver
- 0630 Satin Black

PREMIUM METAL FRAME FINISH COLORS:









- 0605 Matte Black
- 0705 Matte Cotton
- 0788 Glossy Cotton
- 0805 Oasis
- 0905 Mint
- 1005 Mercury
- 1105 Canary
- 1205 Stone
- 1305 Sage
- 1405 Ice Blue
- 1505 Clay

All shipments for this series will be blanket-wrapped as standard. For customers located in Territory 1 who require cartoning, a 5% upcharge will be added to each product. Please contact client services for additional information.

CHANCE GUEST | Designed by Francisco Romero of PhiDesign

ORDERING REQUIREMENTS:

- Model number
- Arm finish, as applicable
- Frame finish
- Upholstery selection
- Options, as applicable

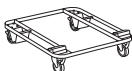
MODEL	PRODUCT SPECIFICATIONS	FABRIC GRADES								LEATHER			
		COM	A	1	2	3	4	COL 5	6	7	8	L1	L2
2510 	 Guest Chair, Fully Upholstered Arms, Glides 23.5" W x 23.5" D x 31" H Seat: 18.5" W x 18.5" D Seat Ht: 17.75" Arm Ht: 26" COM: 1.25 yds. COL: 25 sq. ft. 22 lbs.	614	694	738	764	806	851	891	933	974	1,017	1,214	1,357
2515 	 Guest Chair, Fully Upholstered Arms, Casters 23.5" W x 23.5" D x 31" H Seat: 18.5" W x 18.5" D Seat Ht: 17.75" Arm Ht: 26" COM: 1.25 yds. COL: 25 sq. ft. 22 lbs.	614	694	738	764	806	851	891	933	974	1,017	1,214	1,357
2530 	 Guest Chair, Fully Upholstered Armless, Glides 21" W x 23.5" D x 31" H Seat: 18.5" W x 18.5" D Seat Ht: 17.75" COM: 1.25 yds. COL: 25 sq. ft. 20 lbs.	565	645	689	715	757	802	842	884	925	968	1,165	1,308
2535 	 Guest Chair, Fully Upholstered Armless, Casters 21" W x 23.5" D x 31" H Seat: 18.5" W x 18.5" D Seat Ht: 17.75" COM: 1.25 yds. COL: 25 sq. ft. 20 lbs.	585	665	709	735	777	822	862	904	945	988	1,185	1,328
2500 	Dolly (Black Finish Only) 24" W x 30" D x 6" H 37 lbs.	435											

OPTIONS

-PF02	Premium Metal Frame Finish	\$101	-STC02	Soft Tread Casters	\$33
-SA01	Silver Arms	\$32	-VCT04	VCT Tile Glides	\$28
-EF01	1" Additional Seat Foam	\$44	-MB01	Moisture Barrier (seat only)	\$68
-GCO1	Ganging Connector	\$42			

 = Available on quick-ship program (0535 Metallic Silver base finish only).

All shipments for this series will be blanket-wrapped as standard. For customers located in Territory 1 who require cartoning, a 5% upcharge will be added to each product. Please contact client services for additional information.

CHANCE GUEST | Designed by Francisco Romero of PhiDesign

ORDERING REQUIREMENTS:

- Model number
- Arm finish, as applicable
- Frame finish
- Upholstery selection
- Options, as applicable

MODEL	PRODUCT SPECIFICATIONS	FABRIC GRADES								LEATHER			
		COM	A	1	2	3	4	COL 5	6	7	8	L1	L2
2580 	Bariatric Chair, Fully Upholstered Arms, Glides 34.5" W x 24.5" D x 32" H Seat: 30" W x 19" D Seat Ht: 18" Arm Ht: 26" COM: 2.5 yds. COL: 50 sq. ft. 50 lbs.	1,262	1,422	1,510	1,562	1,645	1,735	1,815	1,900	1,982	2,067	2,462	2,747

OPTIONS

- PF02 Premium Metal Frame Finish \$101
- SA01 Silver Arms \$32
- EF02 1" Additional Seat Foam \$98
- VCT04 VCT Tile Glides \$28
- MB02 Moisture Barrier (seat only) \$89

CHANCE GUEST | Designed by Francisco Romero of PhiDesign

UPHOLSTERY COMBINATIONS:

- For upholstery combinations, refer to the pricing below.
- When combining two COM/COV/COL fabrics, or fabrics with the same grade, add \$120 List per unit.
- When combining three or more COM/COV/COL fabrics, or fabrics with the same grade, add \$150 List per unit.
- When combining different grades of fabric, price will be based on the highest grade specified.
- Two-tone upholstery examples and yardage requirements for the most common combinations are listed below. Additional combinations available; please contact client services for yardage requirements and pricing.
- Note: Yardage amounts are based on fabric which is plain (i.e. non-directional) and a full 54" wide.
- Appropriate upholstery code must be included.



Code	CS1
<u>Model</u>	<u>COM Requirement</u>
2510	Seat = .5 yd.
2515	Back = .75 yd.
2530	
2535	



Code	CS3
<u>Model</u>	<u>COM Requirement</u>
2580	Seat = 1.25 yds.
	Back = 1.25 yds.

All shipments for this series will be blanket-wrapped as standard. For customers located in Territory 1 who require cartoning, a 5% upcharge will be added to each product. Please contact client services for additional information.

CHIRP GUEST



SPECIFICATIONS:

- Three base options available: sled base, swivel base with self-return or wood legs.
- Sled and swivel base available in standard and premium finishes. See below for options.
- For custom finish colors, please contact client services for pricing.
- 300 lb. weight capacity.
- Fixed wood legs offered in all standard finishes on Beech.
- For custom wood finishes, please add \$531 List per color per order.
- For Super Matte Sable Beech finish, upcharge applies. Refer to option section for pricing.
- All dimensions are nominal.
- Refer to terms and conditions for general information regarding fabrics, finishes, warranty, freight, complete condition of sales and more.

STANDARD METAL BASE FINISH COLORS:

- 0405 Charcoal Grey
- 0535 Metallic Silver
- 0199 Chrome (sled base only)
- 0299 Polished Aluminum (swivel base only)
- 0630 Satin Black

PREMIUM METAL BASE FINISH COLORS:



- 0605 Matte Black
- 0705 Matte Cotton
- 0788 Glossy Cotton
- 0805 Oasis
- 0905 Mint
- 1005 Mercury
- 1105 Canary
- 1205 Stone
- 1305 Sage
- 1405 Ice Blue
- 1505 Clay

All shipments for this series will be blanket-wrapped as standard. For customers located in Territory 1 who require cartoning, a 5% upcharge will be added to each product. Please contact client services for additional information.

CHIRP GUEST

ORDERING REQUIREMENTS:

- Model number
- Base finish
- Upholstery selection
- Options, as applicable

MODEL	PRODUCT SPECIFICATIONS	FABRIC GRADES										LEATHER	
		COM	A	1	2	3	4	COL 5	6	7	8	L1	L2
30112 	Guest Chair, Sled Base 21.75" W x 23" D x 32" H Seat: 19.75" W x 17" D Seat Ht: 18" COM: 1.5 yds. COL: 30 sq. ft. 18 lbs.	1,104	1,200	1,253	1,284	1,334	1,388	1,436	1,487	1,536	1,587	1,824	1,995
30113 	Guest Chair, Swivel Base 20.5" W x 23" D x 31.75" H Seat: 19.75" W x 17" D Seat Ht: 17.75" COM: 1.5 yds. COL: 30 sq. ft. 22 lbs.	1,268	1,364	1,417	1,448	1,498	1,552	1,600	1,651	1,700	1,751	1,988	2,159
30114 	Guest Chair, Wood Legs 20.5" W x 23" D x 31.75" H Seat: 19.75" W x 17" D Seat Ht: 17.75" COM: 1.5 yds. COL: 30 sq. ft. 17 lbs.	1,316	1,412	1,465	1,496	1,546	1,600	1,648	1,699	1,748	1,799	2,036	2,207

OPTIONS

-PF02	Premium Metal Base Finish	\$101
-SM02	Super Matte Sable Wood Finish	\$23
-CG02	Clear Glides (sled base models only)	\$12
-FG04	Felt Glides (sled base and wood leg models only)	\$26
-NS04	Non-Skid Glides (sled base and wood leg models only)	\$26

CHIRP GUEST

UPHOLSTERY COMBINATIONS:

- For upholstery combinations, refer to the pricing below.
- When combining two COM/COV/COL fabrics, or fabrics with the same grade, add \$120 List per unit.
- When combining three or more COM/COV/COL fabrics, or fabrics with the same grade, add \$150 List per unit.
- When combining different grades of fabric, price will be based on the highest grade specified.
- Two-tone upholstery examples and yardage requirements for the most common combinations are listed below. Additional combinations available; please contact client services for yardage requirements and pricing.
- Note: Yardage amounts are based on fabric which is plain (i.e. non-directional) and a full 54" wide.
- Appropriate upholstery code must be included.



Code	CH1
<u>Model</u>	<u>COM Requirement</u>
All Models	Side/Front Panels = .75 yd. Balance of Chair = 1.25 yds.



Code	CH2
<u>Model</u>	<u>COM Requirement</u>
All Models	Seat Front/Back Front = .75 yd. Balance of Chair = 1 yd.



Code	CH3
<u>Model</u>	<u>COM Requirement</u>
All Models	Seat Front/Back Front/ Side & Front Panels = 1.25 yds. Balance of Chair = .75 yd.

All shipments for this series will be blanket-wrapped as standard. For customers located in Territory 1 who require cartoning, a 5% upcharge will be added to each product. Please contact client services for additional information.

CHIRP LOUNGE

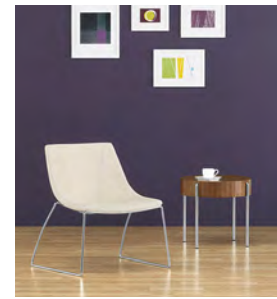

SPECIFICATIONS:

- Two base options available: sled base and swivel base with self-return.
- Bases available in standard and premium finishes. See below for options.
- For custom finish colors, please contact client services for pricing.
- 300 lb. weight capacity.
- All dimensions are nominal.
- Refer to terms and conditions for general information regarding fabrics, finishes, warranty, freight, complete condition of sales and more.

STANDARD METAL BASE FINISH COLORS:

- 0405 Charcoal Grey
- 0535 Metallic Silver
- 0199 Chrome (sled base only)
- 0299 Polished Aluminum (swivel base only)
- 0630 Satin Black

PREMIUM METAL BASE FINISH COLORS:



- 0605 Matte Black
- 0705 Matte Cotton
- 0788 Glossy Cotton
- 0805 Oasis
- 0905 Mint
- 1005 Mercury
- 1105 Canary
- 1205 Stone
- 1305 Sage
- 1405 Ice Blue
- 1505 Clay

All shipments for this series will be blanket-wrapped as standard. For customers located in Territory 1 who require cartoning, a 5% upcharge will be added to each product. Please contact client services for additional information.

CHIRP LOUNGE

ORDERING REQUIREMENTS:

- Model number
- Base finish
- Upholstery selection
- Options, as applicable

MODEL	PRODUCT SPECIFICATIONS	FABRIC GRADES								LEATHER			
		COM	A	1	2	3	4	COL 5	6	7	8	L1	L2
30212-M 	Mid-Back Lounge Chair, Sled Base 26.5" W x 24.25" D x 30" H Seat: 22.5" W x 17" D Seat Ht: 16.5" COM: 1.75 yds. COL: 35 sq. ft. 20 lbs.	1,247	1,359	1,421	1,457	1,515	1,578	1,634	1,694	1,751	1,811	2,087	2,287
30213-M 	Mid-Back Lounge Chair, Swivel Base 23" W x 24.25" D x 30" H Seat: 22.5" W x 17" D Seat Ht: 16.5" COM: 1.75 yds. COL: 35 sq. ft. 22 lbs.	1,410	1,522	1,584	1,620	1,678	1,741	1,797	1,857	1,914	1,974	2,250	2,450

OPTIONS



-PF02	Premium Metal Base Finish	\$101
-CG02	Clear Glides (sled base models only)	\$12
-FG04	Felt Glides (sled base models only)	\$26
-NS04	Non-Skid Glides (sled base models only)	\$26

All shipments for this series will be blanket-wrapped as standard. For customers located in Territory 1 who require cartoning, a 5% upcharge will be added to each product. Please contact client services for additional information.

CHIRP LOUNGE

ORDERING REQUIREMENTS:

- Model number
- Base finish
- Upholstery selection
- Options, as applicable

MODEL	PRODUCT SPECIFICATIONS	FABRIC GRADES										LEATHER	
		COM	A	1	2	3	4	COL 5	6	7	8	L1	L2
30212-H 	High Back Lounge Chair, Sled Base 26.5" W x 24.25" D x 38" H Seat: 22.5" W x 17" D Seat Ht: 16.5" COM: 2 yds. COL: 40 sq. ft. 24 lbs.	1,334	1,462	1,532	1,574	1,640	1,712	1,776	1,844	1,910	1,978	2,294	2,522
30213-H 	High Back Lounge Chair, Swivel Base 23" W x 24.25" D x 38" H Seat: 22.5" W x 17" D Seat Ht: 16.5" COM: 2 yds. COL: 40 sq. ft. 26 lbs.	1,499	1,627	1,697	1,739	1,805	1,877	1,941	2,009	2,075	2,143	2,459	2,687

OPTIONS

-PF02	Premium Metal Base Finish	\$101
-CG02	Clear Glides (sled base models only)	\$12
-FG04	Felt Glides (sled base models only)	\$26
-NS04	Non-Skid Glides (sled base models only)	\$26

CHIRP LOUNGE

UPHOLSTERY COMBINATIONS:

- For upholstery combinations, refer to the pricing below.
- When combining two COM/COV/COL fabrics, or fabrics with the same grade, add \$120 List per unit.
- When combining three or more COM/COV/COL fabrics, or fabrics with the same grade, add \$150 List per unit.
- When combining different grades of fabric, price will be based on the highest grade specified.
- Two-tone upholstery examples and yardage requirements for the most common combinations are listed below. Additional combinations available; please contact client services for yardage requirements and pricing.
- Note: Yardage amounts are based on fabric which is plain (i.e. non-directional) and a full 54" wide.
- Appropriate upholstery code must be included.



Code	CH4
<u>Model</u>	<u>COM Requirement</u>
30212-M	Side/Front Panels = .75 yd.
30213-M	Balance of Chair = 1.5 yds.



Code	CH5
<u>Model</u>	<u>COM Requirement</u>
30212-M	Seat Front/Back Front = .75 yd.
30213-M	Balance of Chair = 1 yd.



Code	CH6
<u>Model</u>	<u>COM Requirement</u>
30212-M	Seat Front/Back Front/ Side & Front Panels = 1.25 yds.
30213-M	Balance of Chair = .75 yd.



Code	CH7
<u>Model</u>	<u>COM Requirement</u>
30212-H	Side/Front Panels = .75 yd.
30213-H	Balance of Chair = 1.5 yds.



Code	CH8
<u>Model</u>	<u>COM Requirement</u>
30212-H	Seat Front/Back Front = .75 yd.
30213-H	Balance of Chair = 1.25 yds.

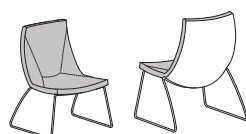

Code	CH9
<u>Model</u>	<u>COM Requirement</u>
30212-H	Seat Front/Back Front/ Side & Front Panels = 1.5 yds.
30213-H	Balance of Chair = .75 yd.

All shipments for this series will be blanket-wrapped as standard. For customers located in Territory 1 who require cartoning, a 5% upcharge will be added to each product. Please contact client services for additional information.

CHIRP STOOLS

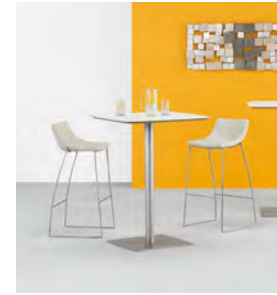

SPECIFICATIONS:

- Bar and counter-height models.
- ½" diameter steel rod frame.
- Frame available in standard and premium finishes. See below for options.
- For custom finish colors, please contact client services for pricing.
- 30" bar-height stool features footrest with 11.5" clearance from the floor.
- 27" counter-height stool features footrest with 10" clearance from the floor.
- 300 lb. weight capacity.
- Optional glides for hard surface flooring.
- All dimensions are nominal.
- Refer to terms and conditions for general information regarding fabrics, finishes, warranty, freight, complete condition of sales and more.

STANDARD METAL FRAME FINISH COLORS:

- 0405 Charcoal Grey
- 0535 Metallic Silver
- 0199 Chrome
- 0630 Satin Black

PREMIUM METAL FRAME FINISH COLORS:



- 0605 Matte Black
- 0705 Matte Cotton
- 0788 Glossy Cotton
- 0805 Oasis
- 0905 Mint
- 1005 Mercury
- 1105 Canary
- 1205 Stone
- 1305 Sage
- 1405 Ice Blue
- 1505 Clay

All shipments for this series will be blanket-wrapped as standard. For customers located in Territory 1 who require cartoning, a 5% upcharge will be added to each product. Please contact client services for additional information.

CHIRP STOOLS

ORDERING REQUIREMENTS:

- Model number
- Frame finish
- Upholstery selection
- Options, as applicable

MODEL	PRODUCT SPECIFICATIONS	FABRIC GRADES								LEATHER			
		COM	A	1	2	3	4	COL 5	6	7	8	L1	L2
30612-27 	Counter-Height Stool 19.75" W x 20.5" D x 35.5" H Seat: 16" W x 14" D Seat Ht: 27" COM: 1 yd. COL: 20 sq. ft. 14 lbs.	1,111	1,175	1,210	1,231	1,264	1,300	1,332	1,366	1,399	1,433	1,591	1,705
30612-30 	Bar-Height Stool 19.75" W x 20.5" D x 38.5" H Seat: 16" W x 14" D Seat Ht: 30" COM: 1 yd. COL: 20 sq. ft. 16 lbs.	1,131	1,195	1,230	1,251	1,284	1,320	1,352	1,386	1,419	1,453	1,611	1,725

OPTIONS

-PF02	Premium Metal Frame Finish	\$101
-CG02	Clear Glides	\$12
-FG04	Felt Glides	\$26

CHIRP STOOLS

UPHOLSTERY COMBINATIONS:

- For upholstery combinations, refer to the pricing below.
- When combining two COM/COV/COL fabrics, or fabrics with the same grade, add \$120 List per unit.
- When combining three or more COM/COV/COL fabrics, or fabrics with the same grade, add \$150 List per unit.
- When combining different grades of fabric, price will be based on the highest grade specified.
- Two-tone upholstery examples and yardage requirements for the most common combinations are listed below. Additional combinations available; please contact client services for yardage requirements and pricing.
- Note: Yardage amounts are based on fabric which is plain (i.e. non-directional) and a full 54" wide.
- Appropriate upholstery code must be included.



Code	CH10
<u>Model</u>	<u>COM Requirement</u>
All Models	Side/Front Panels = .5 yd. Balance of Chair = .75 yd.



Code	CH11
<u>Model</u>	<u>COM Requirement</u>
All Models	Seat Front/Back Front = .5 yd. Balance of Chair = .5 yd.



Code	CH12
<u>Model</u>	<u>COM Requirement</u>
All Models	Seat Front/Back Front/ Side & Front Panels = .75 yd. Balance of Chair = .5 yd.

All shipments for this series will be blanket-wrapped as standard. For customers located in Territory 1 who require cartoning, a 5% upcharge will be added to each product. Please contact client services for additional information.

CIELO® LOUNGE | Designed by Chris Panichella



SPECIFICATIONS:

- Lounge and love seat models.
- Sled base comprised of 3/4" diameter tubular steel.
- Swivel base lounge chairs also offered.
- Swivel base models feature self-return.
- Sled and swivel base offered in standard and premium finishes. See below for options.
- For custom finish colors, please contact client services for pricing.
- Lounge chair features 350 lb. weight capacity.
- Love seat features 600 lb. weight capacity.
- All dimensions are nominal.
- Refer to terms and conditions for general information regarding fabrics, finishes, warranty, freight, complete condition of sales and more.

STANDARD METAL BASE FINISH COLORS:

- 0405 Charcoal Grey
- 0535 Metallic Silver
- 0199 Chrome (sled base only)
- 0299 Polished Aluminum (swivel base only)
- 0630 Satin Black

PREMIUM METAL BASE FINISH COLORS:



- 0605 Matte Black
- 0705 Matte Cotton
- 0788 Glossy Cotton
- 0805 Oasis
- 0905 Mint
- 1005 Mercury
- 1105 Canary
- 1205 Stone
- 1305 Sage
- 1405 Ice Blue
- 1505 Clay

All shipments for this series will be blanket-wrapped as standard. For customers located in Territory 1 who require cartoning, a 5% upcharge will be added to each product. Please contact client services for additional information.

CIELO® LOUNGE | Designed by Chris Panichella

ORDERING REQUIREMENTS:

- Model number
- Base finish
- Upholstery selection
- Options, as applicable

MODEL	PRODUCT SPECIFICATIONS	FABRIC GRADES								LEATHER			
		COM	A	1	2	3	4	COL 5	6	7	8	L1	L2
8070 	Lounge Chair, Sled Base 22.5" W x 27.25" D x 30.5" H Seat: 22.5" W x 17" D Seat Ht: 17" COM: 1.75 yds. COL: 35 sq. ft. 25 lbs.	1,507	1,619	1,681	1,717	1,775	1,838	1,894	1,954	2,011	2,071	2,347	2,547
8080 	Love Seat, Sled Base 44.5" W x 27.25" D x 30.5" H Seat: 44.5" W x 17" D Seat Ht: 17" COM: 2.75 yds. COL: 55 sq. ft. 40 lbs.	2,231	2,407	2,504	2,561	2,652	2,751	2,839	2,933	3,023	3,117	3,551	3,865

OPTIONS

-PF02	Premium Metal Base Finish	\$101
-MB01	Moisture Barrier (lounge, seat only)	\$68
-MB02	Moisture Barrier (love seat, seat only)	\$89
-NS04	Non-Skid Glides	\$26

All shipments for this series will be blanket-wrapped as standard. For customers located in Territory 1 who require cartoning, a 5% upcharge will be added to each product. Please contact client services for additional information.

CIELO® LOUNGE | Designed by Chris Panichella

ORDERING REQUIREMENTS:

- Model number
- Base finish
- Upholstery selection
- Options, as applicable

MODEL	PRODUCT SPECIFICATIONS	FABRIC GRADES								LEATHER			
		COM	A	1	2	3	4	COL 5	6	7	8	L1	L2
8075 	Lounge Chair, Swivel Base 28" W x 27.25" D x 30.5" H Seat: 22.5" W x 17" D Seat Ht: 17" COM: 1.75 yds. COL: 35 sq. ft. 32 lbs.	1,818	1,930	1,992	2,028	2,086	2,149	2,205	2,265	2,322	2,382	2,658	2,858

OPTIONS

- PF02 Premium Metal Base Finish \$101
- MB01 Moisture Barrier (seat only) \$68
- NS04 Non-Skid Glides \$26

CIELO® LOUNGE | Designed by Chris Panichella

UPHOLSTERY COMBINATIONS:

- For upholstery combinations, refer to the pricing below.
- When combining two COM/COV/COL fabrics, or fabrics with the same grade, add \$120 List per unit.
- When combining three or more COM/COV/COL fabrics, or fabrics with the same grade, add \$150 List per unit.
- When combining different grades of fabric, price will be based on the highest grade specified.
- Two-tone upholstery examples and yardage requirements for the most common combinations are listed below. Additional combinations available; please contact client services for yardage requirements and pricing.
- Note: Yardage amounts are based on fabric which is plain (i.e. non-directional) and a full 54" wide.
- Appropriate upholstery code must be included.



Code **CC1**
Model COM Requirement
8070 Top of Seat & Front of Back = .75 yd.
 Balance of Chair = 1.5 yds.

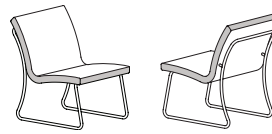

Code **CC2**
Model COM Requirement
8070 Band = .75 yd.
 Balance of Chair = 1.5 yds.



Code **CC3**
Model COM Requirement
8075 Top of Seat & Front of Back = .75 yd.
8077 Balance of Chair = 1.5 yds.



Code **CC4**
Model COM Requirement
8075 Band = .75 yd.
8077 Balance of Chair = 1.5 yds.



Code **CC5**
Model COM Requirement
8080 Top of Seat & Front of Back = 1 yd.
 Balance of Chair = 1.75 yds.

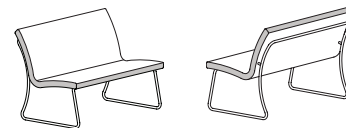

Code **CC6**
Model COM Requirement
8080 Band = .75 yd.
 Balance of Chair = 2 yds.

All shipments for this series will be blanket-wrapped as standard. For customers located in Territory 1 who require cartoning, a 5% upcharge will be added to each product. Please contact client services for additional information.

CIELO® OCCASIONAL TABLES | Designed by Chris Panichella



SPECIFICATIONS:

- Round and square top shapes.
- Pull-up table also available.
- Occasional tables offered with laminate, solid surface and glass top surface options.
- Pull-up table available in laminate and solid surface only.
- For standard wood grain laminate or solid black laminate tops, edge will match unless specified otherwise.
- For all other solid laminates, edge will be exposed plywood substrate with clear coat finish.
- Solid surface available in white only.
- Glass tops are back-painted white as standard and may be used as a writable surface with dry-erase markers.
- Back-painted glass and solid surface tops feature exposed plywood substrate edge with clear coat finish.
- Laminate available in all standard colors.
- For custom laminate options, add \$649 List per color per order. Pre-approval required, please contact client services.
- Laminate tops are 3/4" thick, solid surface tops are 1/2" thick and back-painted glass tops are 1/4" thick.
- Metal base available in standard and premium finishes. See below for options.
- For custom metal finish colors, please contact client services for pricing.
- All dimensions are nominal.
- Refer to terms and conditions for general information regarding finishes, warranty, freight, complete condition of sales and more.

STANDARD METAL BASE FINISH COLORS:

- 0405 Charcoal Grey
- 0535 Metallic Silver
- 0199 Chrome
- 0630 Satin Black

PREMIUM METAL BASE FINISH COLORS:

- 0605 Matte Black
- 0705 Matte Cotton
- 0788 Glossy Cotton
- 0805 Oasis
- 0905 Mint
- 1005 Mercury
- 1105 Canary
- 1205 Stone
- 1305 Sage
- 1405 Ice Blue
- 1505 Clay

All shipments for this series will be blanket-wrapped as standard. For customers located in Territory 1 who require cartoning, a 5% upcharge will be added to each product. Please contact client services for additional information.

CIELO® OCCASIONAL TABLES | Designed by Chris Panichella

ORDERING REQUIREMENTS:

- Model number
- Table top finish
- Base finish
- Options, as applicable

	MODEL	DIMENSIONS	LAMINATE TOP (-L)	SOLID SURFACE TOP (-SF)	BACK-PAINTED GLASS TOP (-GL)	WEIGHT
	Round Table 8060-1818-() 8060-2218-()	18" Dia. x 18" H 22" Dia. x 18" H	1,207 1,274	1,381 1,580	1,290 1,382	11 lbs. 13 lbs.
	Square Table 8065-181818-() 8065-222218-()	18" W x 18" D x 18" H 22" W x 22" D x 18" H	1,162 1,199	1,336 1,505	1,248 1,307	13 lbs. 15 lbs.

OPTIONS

- PF02 Premium Metal Base Finish \$101
- NS04 Non-Skid Glides \$26

Note: Round solid surface and glass tops may vary slightly in size from the dimensions listed above. Please contact client services if exact dimensions are required.



Ⓞ = Available on quick-ship program (laminates and glass tops with O535 Metallic Silver or O199 Chrome base finishes only).

All shipments for this series will be blanket-wrapped as standard. For customers located in Territory 1 who require cartoning, a 5% upcharge will be added to each product. Please contact client services for additional information.

CIELO® PULL-UP TABLE | Designed by Chris Panichella

ORDERING REQUIREMENTS:

- Model number
- Table top finish
- Base finish
- Options, as applicable

MODEL	DESCRIPTION	LAMINATE TOP (-L)	SOLID SURFACE TOP (-SF)	WEIGHT
8055-() 	 Free-Standing Pull-Up Table 18" W x 14" D x 26.5" H	1,049	1,195	16 lbs.

OPTIONS

-PF02 Premium Metal Base Finish \$101

 = Available on quick-ship program (laminated tops with 0535 Metallic Silver or 0199 Chrome base finishes only).

All shipments for this series will be blanket-wrapped as standard. For customers located in Territory 1 who require cartoning, a 5% upcharge will be added to each product. Please contact client services for additional information.

CLIPSE LOUNGE | Designed by 5d Studio



SPECIFICATIONS:

- Lounge, love seat and sofa models available with wood legs or platform base with metal legs.
- Wood legs available in all standard finishes on Ash.
- For custom wood finishes, please add \$531 List per color per order.
- For Super Matte Sable Ash finish, upcharge applies. Refer to option section for pricing.
- Platform base with metal legs available in standard and premium finishes. See following page for options.
- For custom metal finish colors, please contact client services for pricing.
- VCT tile glides available for hard surface floors. Please specify "-VCT04" after model number and add \$28 List per unit.
- Swivel base also offered.
- Swivel base is finished in stainless steel and features 360-degree turning radius with self-return.
- Standard and premium base finishes also offered on swivel base model.
- 350 lb. weight capacity.
- All dimensions are nominal.
- Refer to terms and conditions for general information regarding fabrics, finishes, warranty, freight, complete condition of sales and more.

ROTATING TABLET:

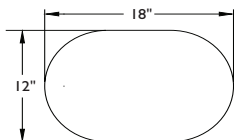

- Tablet affixed to right or left arm, as specified.
- Tablet size is 18" W x 12" D x .75" thick and features 360-degree turning radius.
- Two tablet surface options: Laminate and solid surface.
- Solid surface available in white only.
- Solid surface tops feature exposed plywood substrate edge with clear coat finish.
- For custom laminate options, add \$649 List per color per order. Pre-approval required, please contact client services.
- For standard wood grain laminate or solid black laminate tops, edge will match unless specified otherwise.
- For all other solid laminates, edge will be exposed plywood substrate with clear coat finish.
- Tablet mounting bracket features 0535 Metallic Silver finish as standard. 0630 Satin Black finish also available. Please specify.
- 100 lb. weight capacity.

CLIPSE LOUNGE | Designed by 5d Studio

POWER UNITS:

- Available on fixed leg models only (not available on swivel base version).
- Dimensions: 5.25" W x 4.25" L
- Touch latch lid provides easy access to electrical features.
- 72" electrical cord (no hardwire option available for this series).
- Unit will be positioned on right side, as seated, unless otherwise specified.
- If specified in conjunction with a tablet, power unit will be mounted to same side as tablet, unless otherwise specified.
- UL listed.

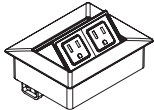

Portal Power 2 (PP2):

- Two outlets.
- Touch latch lid with metallic silver finish

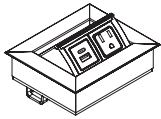

Portal Power 3 (PP3):

- One outlet, one USB-A and one USB-C charging ports.
- Touch latch lid with metallic silver finish

STANDARD METAL BASE FINISH COLORS:

- 0405 Charcoal Grey
- 0535 Metallic Silver
- 0199 Chrome (metal leg base only)
- 0399 Polished Stainless Steel (swivel base only)
- 0630 Satin Black

PREMIUM METAL BASE FINISH COLORS:





- 0605 Matte Black
- 0705 Matte Cotton
- 0788 Glossy Cotton
- 0805 Oasis
- 0905 Mint
- 1005 Mercury
- 1105 Canary
- 1205 Stone
- 1305 Sage
- 1405 Ice Blue
- 1505 Clay

All shipments for this series will be blanket-wrapped as standard. For customers located in Territory 1 who require cartoning, a 5% upcharge will be added to each product. Please contact client services for additional information.

CLIPSE LOUNGE | Designed by 5d Studio

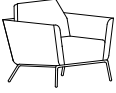
ORDERING REQUIREMENTS:

- Model number
- Base finish
- Upholstery selection
- Options, as applicable

MODEL	PRODUCT SPECIFICATIONS	FABRIC GRADES								LEATHER			
		COM	A	1	2	3	4	COL 5	6	7	8	L1	L2
6270 	 Lounge Chair, Metal Legs 32" W x 29" D x 29.5" H Seat: 24" W x 20" D Seat Ht: 17.5" COM: 4 yds. COL: 80 sq. ft. 55 lbs.	2,063	2,319	2,459	2,543	2,675	2,819	2,947	3,083	3,215	3,351	3,983	4,439
6270-W 	Lounge Chair, Wood Legs 32" W x 29" D x 29.5" H Seat: 24" W x 20" D Seat Ht: 17.5" COM: 4 yds. COL: 80 sq. ft. 55 lbs.	2,187	2,443	2,583	2,667	2,799	2,943	3,071	3,207	3,339	3,475	4,107	4,563
6276 	Lounge Chair, Swivel Base 32" W x 29" D x 29.5" H Seat: 24" W x 20" D Seat Ht: 17.5" COM: 4 yds. COL: 80 sq. ft. 72 lbs.	2,434	2,690	2,830	2,914	3,046	3,190	3,318	3,454	3,586	3,722	4,354	4,810

OPTIONS

-PF02	Premium Metal Base Finish, Fixed Metal Leg Models	\$101	-PP2	Portal Power 2 (dual power)	\$758
-PF04	Premium Metal Base Finish, Swivel Base Models	\$172	-PP3	Portal Power 3 (1 power, 2 USB)	\$895
-SM01	Super Matte Sable Wood Finish	\$12	-NS04	Non-Skid Glides (wood leg models only)	\$26
-TAR01-L	Laminate Rotating Tablet, Right (as seated)	\$570	-VCT04	VCT Tile Glides (fixed metal leg models only)	\$28
-TAL01-L	Laminate Rotating Tablet, Left (as seated)				
-TAR01-SF	Solid Surface Rotating Tablet, Right (as seated)	\$683			
-TAL01-SF	Solid Surface Rotating Tablet, Left (as seated)				





 = Available on quick-ship program (0535 Metallic Silver and 0199 Chrome base finishes only).

All shipments for this series will be blanket-wrapped as standard. For customers located in Territory 1 who require cartoning, a 5% upcharge will be added to each product. Please contact client services for additional information.

CLIPSE LOUNGE | Designed by 5d Studio

ORDERING REQUIREMENTS:

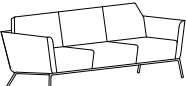
- Model number
- Base finish
- Upholstery selection
- Options, as applicable

MODEL	PRODUCT SPECIFICATIONS	FABRIC GRADES								LEATHER			
		COM	A	1	2	3	4	COL 5	6	7	8	L1	L2
6280 	Love Seat, Metal Legs 58" W x 29" D x 29.5" H Seat: 49" W x 20" D Seat Ht: 17.5" COM: 5.5 yds. COL: 110 sq. ft. 85 lbs.	2,886	3,238	3,431	3,546	3,728	3,926	4,102	4,289	4,470	4,657	5,526	6,153
6280-W 	Love Seat, Wood Legs 58" W x 29" D x 29.5" H Seat: 49" W x 20" D Seat Ht: 17.5" COM: 5.5 yds. COL: 110 sq. ft. 85 lbs.	3,035	3,387	3,580	3,695	3,877	4,075	4,251	4,438	4,619	4,806	5,675	6,302
6290 	Sofa, Metal Legs 81.5" W x 29" D x 29.5" H Seat: 73" W x 20" D Seat Ht: 17.5" COM: 7.25 yds. COL: 145 sq. ft. 130 lbs.	4,090	4,554	4,808	4,960	5,200	5,461	5,693	5,939	6,178	6,425	7,570	8,397
6290-W 	Sofa, Wood Legs 81.5" W x 29" D x 29.5" H Seat: 73" W x 20" D Seat Ht: 17.5" COM: 7.25 yds. COL: 145 sq. ft. 130 lbs.	4,153	4,617	4,871	5,023	5,263	5,524	5,756	6,002	6,241	6,488	7,633	8,460

OPTIONS

-PF02	Premium Metal Base Finish	\$101	-PP2	Portal Power 2 (dual power)	\$758
-SM01	Super Matte Sable Wood Finish	\$12	-PP3	Portal Power 3 (1 power, 2 USB)	\$895
-TAR01-L	Laminate Rotating Tablet, Right (as seated)	\$570	-NS04	Non-Skid Glides (wood leg models only)	\$26
-TAL01-L	Laminate Rotating Tablet, Left (as seated)		-VCT04	VCT Tile Glides (fixed metal leg models only)	\$28
-TAR01-SF	Solid Surface Rotating Tablet, Right (as seated)	\$683			
-TAL01-SF	Solid Surface Rotating Tablet, Left (as seated)				

CLIPSE LOUNGE | Designed by 5d Studio

UPHOLSTERY COMBINATIONS:

- For upholstery combinations, refer to the pricing below.
- When combining two COM/COV/COL fabrics, or fabrics with the same grade, add \$120 List per unit.
- When combining three or more COM/COV/COL fabrics, or fabrics with the same grade, add \$150 List per unit.
- When combining different grades of fabric, price will be based on the highest grade specified.
- Two-tone upholstery examples and yardage requirements for the most common combinations are listed below. Additional combinations available; please contact client services for yardage requirements and pricing.
- Note: Yardage amounts are based on fabric which is plain (i.e. non-directional) and a full 54" wide.
- Appropriate upholstery code must be included.

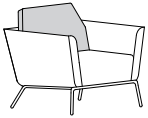

Code	CL1
<u>Model</u>	<u>COM Requirement</u>
6270	Back Cushion Only = 1.25 yds.
6270-W	Balance of Chair = 3.5 yds.
6276	

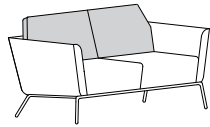

Code	CL2
<u>Model</u>	<u>COM Requirement</u>
6280	Back Cushion Only = 1.75 yds.
6280-W	Balance of Love Seat = 4.25 yds.

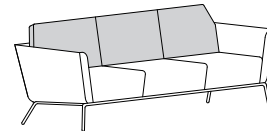

Code	CL3
<u>Model</u>	<u>COM Requirement</u>
6290	Back Cushion Only = 2.25 yds.
6290-W	Balance of Sofa = 5.5 yds.

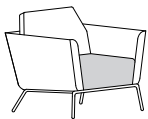

Code	CL4
<u>Model</u>	<u>COM Requirement</u>
6270	Seat Cushion Only = 1.25 yds.
6270-W	Balance of Chair = 3 yds.
6276	

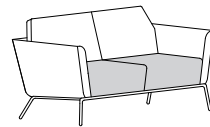

Code	CL5
<u>Model</u>	<u>COM Requirement</u>
6280	Seat Cushion Only = 1.75 yds.
6280-W	Balance of Love Seat = 4 yds.

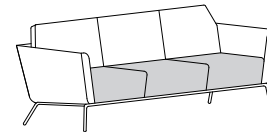

Code	CL6
<u>Model</u>	<u>COM Requirement</u>
6290	Seat Cushion Only = 2.5 yds.
6290-W	Balance of Sofa = 5 yds.

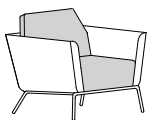

Code	CL7
<u>Model</u>	<u>COM Requirement</u>
6270	Back & Seat Cushion = 2 yds.
6270-W	Balance of Chair = 2.75 yds.
6276	

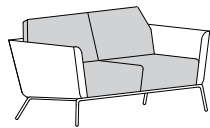

Code	CL8
<u>Model</u>	<u>COM Requirement</u>
6280	Back & Seat Cushion = 3.25 yds.
6280-W	Balance of Love Seat = 2.5 yds.

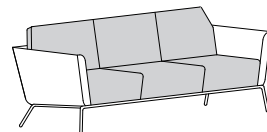

Code	CL9
<u>Model</u>	<u>COM Requirement</u>
6290	Back & Seat Cushion = 4.5 yds.
6290-W	Balance of Sofa = 3.25 yds.

All shipments for this series will be cartoned as standard. If blanket-wrapped shipping is required, please contact client services for additional information.

ESPO | Designed by Henner Jahns of Gecco Vision



SPECIFICATIONS:

- Adjustable t-arm and signature polished aluminum cantilever arm models.
- Polished aluminum cantilever arm features black polyurethane arm cap.
- Adjustable t-arm features 3" arm height adjustment.
- Weight-activated synchro-tilt and swivel-tilt mechanism options.
- Fixed back height.
- Black nylon base as standard.
- Polished aluminum base also available. Please specify (-ABO2) after model number and refer to listed pricing.
- 300 lb. weight capacity.
- All dimensions are nominal.
- Refer to terms and conditions for general information regarding fabrics, finishes, warranty, freight, complete condition of sales and more.



All shipments for this series will be cartoned as standard. If blanket-wrapped shipping is required, please contact client services for additional information.

ESPO | Designed by Henner Jahns of Gecco Vision

Weight-Activated Synchro-Tilt Mechanism

ORDERING REQUIREMENTS:

- Model number
- Base finish
- Upholstery selection
- Options, as applicable

MODEL	PRODUCT SPECIFICATIONS	BASE FINISH	FABRIC GRADES								LEATHER			
			COM	A	1	2	3	4	COL 5	6	7	8	L1	L2
8413 	Adjustable T-Arms 25.5" W x 23.75" D x 38.75" - 42.75" H Seat: 21" W x 18.75" D Seat Ht: 16" - 20" Back: 21" W x 24" H COM: 1.75 yds. COL: 35 sq. ft. 40 lbs.	Black Nylon	1,606	1,718	1,780	1,816	1,874	1,937	1,993	2,053	2,110	2,170	2,446	2,646
		Polished Aluminum	1,793	1,905	1,967	2,003	2,061	2,124	2,180	2,240	2,297	2,357	2,633	2,833
8414 	Cantilever Arms 27" W x 23.75" D x 38.75" - 42.75" H Seat: 21" W x 18.75" D Seat Ht: 16" - 20" Back: 21" W x 24" H COM: 1.75 yds. COL: 35 sq. ft. 40 lbs.	Black Nylon	1,722	1,834	1,896	1,932	1,990	2,053	2,109	2,169	2,226	2,286	2,562	2,762
		Polished Aluminum	1,909	2,021	2,083	2,119	2,177	2,240	2,296	2,356	2,413	2,473	2,749	2,949

OPTIONS

- STC02 Soft Tread Casters \$33
- STLC02 Soft Tread Self-Locking Casters \$63

 = Available on quick-ship program.



All shipments for this series will be cartoned as standard. If blanket-wrapped shipping is required, please contact client services for additional information.

ESPO | Designed by Henner Jahns of Gecco Vision

Swivel-Tilt with Tilt-Lock Mechanism

ORDERING REQUIREMENTS:

- Model number
- Base finish
- Upholstery selection
- Options, as applicable

MODEL	PRODUCT SPECIFICATIONS	BASE FINISH	FABRIC GRADES								LEATHER			
			COM	A	1	2	3	4	COL 5	6	7	8	L1	L2
8453 	Adjustable T-Arms 25.5" W x 23.75" D x 38.75" - 42.75" H Seat: 21" W x 18.75" D Seat Ht: 16" - 20" Back: 21" W x 24" H COM: 1.75 yds. COL: 35 sq. ft. 40 lbs.	Black Nylon	1,600	1,712	1,774	1,810	1,868	1,931	1,987	2,047	2,104	2,164	2,440	2,640
		Polished Aluminum	1,787	1,899	1,961	1,997	2,055	2,118	2,174	2,234	2,291	2,351	2,627	2,827
8454 	Cantilever Arms 27" W x 23.75" D x 38.75" - 42.75" H Seat: 21" W x 18.75" D Seat Ht: 16" - 20" Back: 21" W x 24" H COM: 1.75 yds. COL: 35 sq. ft. 40 lbs.	Black Nylon	1,716	1,828	1,890	1,926	1,984	2,047	2,103	2,163	2,220	2,280	2,556	2,756
		Polished Aluminum	1,903	2,015	2,077	2,113	2,171	2,234	2,290	2,350	2,407	2,467	2,743	2,943

OPTIONS

- STC02 Soft Tread Casters \$33
- STLC02 Soft Tread Self-Locking Casters \$63

 = Available on quick-ship program.

All shipments for this series will be blanket-wrapped as standard. For customers located in Territory 1 who require cartoning, a 5% upcharge will be added to each product. Please contact client services for additional information.

FACTION EXECUTIVE + TASK | Designed by 5d Studio



SPECIFICATIONS:

- Executive and task models.
- Executive models available with polished aluminum cantilever arms or loop arms.
- Task models offered with adjustable t-arms that feature 3" travel.
- Weight-activated and synchro-tilt mechanism options.
- Fixed back height.
- Black nylon base as standard.
- Polished aluminum base also available. Please specify (-ABO2) after model number and refer to listed pricing.
- 300 lb. weight capacity.
- All dimensions are nominal.
- Refer to terms and conditions for general information regarding fabrics, finishes, warranty, freight, complete condition of sales and more.



All shipments for this series will be blanket-wrapped as standard. For customers located in Territory 1 who require cartoning, a 5% upcharge will be added to each product. Please contact client services for additional information.

FACTION EXECUTIVE | Designed by 5d Studio

Weight-Activated Synchro-Tilt Mechanism

ORDERING REQUIREMENTS:

- Model number
- Base finish
- Upholstery selection
- Options, as applicable

MODEL	PRODUCT SPECIFICATIONS	BASE FINISH	FABRIC GRADES								LEATHER			
			COM	A	1	2	3	4	COL 5	6	7	8	L1	L2
1812-M 	Mid-Back, Cantilever Arms 23.5" W x 23" D x 38.5" - 42.5" H Seat: 19" W x 18" D Seat Ht: 17.5" - 21.5" Back : 19" W x 21" H COM: 1.75 yds. COL: 35 sq. ft. 45 lbs.	Black Nylon	1,816	1,928	1,990	2,026	2,084	2,147	2,203	2,263	2,320	2,380	2,656	2,856
		Polished Aluminum	2,003	2,115	2,177	2,213	2,271	2,334	2,390	2,450	2,507	2,567	2,843	3,043
1814-M 	Mid-Back, Loop Arms 23" W x 23" D x 38.5" - 42.5" H Seat: 19" W x 18" D Seat Ht: 17.5" - 21.5" Back : 19" W x 21" H COM: 1.75 yds. COL: 35 sq. ft. 46 lbs.	Black Nylon	1,861	1,973	2,035	2,071	2,129	2,192	2,248	2,308	2,365	2,425	2,701	2,901
		Polished Aluminum	2,048	2,160	2,222	2,258	2,316	2,379	2,435	2,495	2,552	2,612	2,888	3,088

OPTIONS

- STC02 Soft Tread Casters \$33
- STLC02 Soft Tread Self-Locking Casters \$63



All shipments for this series will be blanket-wrapped as standard. For customers located in Territory 1 who require cartoning, a 5% upcharge will be added to each product. Please contact client services for additional information.

FACTION EXECUTIVE | Designed by 5d Studio

Weight-Activated Synchro-Tilt Mechanism

ORDERING REQUIREMENTS:

- Model number
- Base finish
- Upholstery selection
- Options, as applicable

MODEL	PRODUCT SPECIFICATIONS	BASE FINISH	FABRIC GRADES								LEATHER			
			COM	A	1	2	3	4	COL 5	6	7	8	L1	L2
1812-H 	High Back, Cantilever Arms 23.5" W x 23" D x 45.5" - 49.5" H Seat: 19" W x 18" D Seat Ht: 17.5" - 21.5" Back : 19" W x 28.5" H COM: 2 yds. COL: 40 sq. ft. 48 lbs.	Black Nylon	1,892	2,020	2,090	2,132	2,198	2,270	2,334	2,402	2,468	2,536	2,852	3,080
		Polished Aluminum	2,079	2,207	2,277	2,319	2,385	2,457	2,521	2,589	2,655	2,723	3,039	3,267
1814-H 	High Back, Loop Arms 23" W x 23" D x 45.5" - 49.5" H Seat: 19" W x 18" D Seat Ht: 17.5" - 21.5" Back : 19" W x 28.5" H COM: 2 yds. COL: 40 sq. ft. 49 lbs.	Black Nylon	1,936	2,064	2,134	2,176	2,242	2,314	2,378	2,446	2,512	2,580	2,896	3,124
		Polished Aluminum	2,123	2,251	2,321	2,363	2,429	2,501	2,565	2,633	2,699	2,767	3,083	3,311

OPTIONS

-STC02	Soft Tread Casters	\$33
-STLC02	Soft Tread Self-Locking Casters	\$63



All shipments for this series will be blanket-wrapped as standard. For customers located in Territory 1 who require cartoning, a 5% upcharge will be added to each product. Please contact client services for additional information.

FACTION EXECUTIVE | Designed by 5d Studio

Synchro-Tilt Mechanism

ORDERING REQUIREMENTS:

- Model number
- Base finish
- Upholstery selection
- Options, as applicable

MODEL	PRODUCT SPECIFICATIONS	BASE FINISH	FABRIC GRADES								LEATHER			
			COM	A	1	2	3	4	COL 5	6	7	8	L1	L2
1892-M 	Mid-Back, Cantilever Arms 23.5" W x 23" D x 38.5" - 42.5" H Seat: 19" W x 18" D Seat Ht: 17.5" - 21.5" Back: 19" W x 21" H COM: 1.75 yds. COL: 35 sq. ft. 45 lbs.	Black Nylon	1,643	1,755	1,817	1,853	1,911	1,974	2,030	2,090	2,147	2,207	2,483	2,683
		Polished Aluminum	1,830	1,942	2,004	2,040	2,098	2,161	2,217	2,277	2,334	2,394	2,670	2,870
1894-M 	Mid-Back, Loop Arms 23" W x 23" D x 38.5" - 42.5" H Seat: 19" W x 18" D Seat Ht: 17.5" - 21.5" Back: 19" W x 21" H COM: 1.75 yds. COL: 35 sq. ft. 46 lbs.	Black Nylon	1,855	1,967	2,029	2,065	2,123	2,186	2,242	2,302	2,359	2,419	2,695	2,895
		Polished Aluminum	2,042	2,154	2,216	2,252	2,310	2,373	2,429	2,489	2,546	2,606	2,882	3,082

OPTIONS

-SS01	Seat Slider	\$102
-STC02	Soft Tread Casters	\$33
-STLC02	Soft Tread Self-Locking Casters	\$63



All shipments for this series will be blanket-wrapped as standard. For customers located in Territory 1 who require cartoning, a 5% upcharge will be added to each product. Please contact client services for additional information.

FACTION EXECUTIVE | Designed by 5d Studio

Synchro-Tilt Mechanism

ORDERING REQUIREMENTS:

- Model number
- Base finish
- Upholstery selection
- Options, as applicable

MODEL	PRODUCT SPECIFICATIONS	BASE FINISH	FABRIC GRADES								LEATHER			
			COM	A	1	2	3	4	COL 5	6	7	8	L1	L2
1892-H 	High Back, Cantilever Arms 23.5" W x 23" D x 45.5" - 49.5" H Seat: 19" W x 18" D Seat Ht: 17.5" - 21.5" Back: 19" W x 28.5" H COM: 2 yds. COL: 40 sq. ft. 48 lbs.	Black Nylon	1,753	1,881	1,951	1,993	2,059	2,131	2,195	2,263	2,329	2,397	2,713	2,941
		Polished Aluminum	1,940	2,068	2,138	2,180	2,246	2,318	2,382	2,450	2,516	2,584	2,900	3,128
1894-H 	High Back, Loop Arms 23" W x 23" D x 45.5" - 49.5" H Seat: 19" W x 18" D Seat Ht: 17.5" - 21.5" Back: 19" W x 28.5" H COM: 2 yds. COL: 40 sq. ft. 49 lbs.	Black Nylon	1,848	1,976	2,046	2,088	2,154	2,226	2,290	2,358	2,424	2,492	2,808	3,036
		Polished Aluminum	2,035	2,163	2,233	2,275	2,341	2,413	2,477	2,545	2,611	2,679	2,995	3,223

OPTIONS

-SS01	Seat Slider	\$102
-STC02	Soft Tread Casters	\$33
-STLC02	Soft Tread Self-Locking Casters	\$63

All shipments for this series will be blanket-wrapped as standard. For customers located in Territory 1 who require cartoning, a 5% upcharge will be added to each product. Please contact client services for additional information.

FACTION TASK | Designed by 5d Studio

Synchro-Tilt Mechanism

ORDERING REQUIREMENTS:

- Model number
- Base finish
- Upholstery selection
- Options, as applicable

MODEL	PRODUCT SPECIFICATIONS	BASE FINISH	FABRIC GRADES								LEATHER			
			COM	A	1	2	3	4	COL 5	6	7	8	L1	L2
1893 	Adjustable T-Arms 27.75" W x 23" D x 38.5" - 42.5" H Seat: 19.5" W x 18" D Seat Ht: 17.5" - 21.5" Back: 19.5" W x 21"H COM: 1.75 yds. COL: 35 sq. ft. 40 lbs.	Black Nylon	1,579	1,691	1,753	1,789	1,847	1,910	1,966	2,026	2,083	2,143	2,419	2,619
		Polished Aluminum	1,766	1,878	1,940	1,976	2,034	2,097	2,153	2,213	2,270	2,330	2,606	2,806

OPTIONS

-SS01	Seat Slider	\$102
-CT01	Chrome Trim Arm Detail	\$67
-STC02	Soft Tread Casters	\$33
-STLC02	Soft Tread Self-Locking Casters	\$63

All shipments for this series will be blanket-wrapped as standard. For customers located in Territory 1 who require cartoning, a 5% upcharge will be added to each product. Please contact client services for additional information.

FACTION GUEST + NESTING | Designed by 5d Studio



SPECIFICATIONS:

- Fully upholstered and poly-back models.
- Polypropylene back available in four colors.
- Tubular steel frame.
- Guest models available with three arm options: armless, metal cantilever arms or polypropylene loop arms.
- Nesting models feature flip-up seat and are offered armless or with metal cantilever arms.
- Please see below for back and arm finish options.
- Metal arm finish will match frame finish unless specified otherwise.
- For custom finish colors, please contact client services for pricing.
- Guest models with glides feature wall-saver leg design.
- If cartoning is required, chairs are packaged in units of three (3). A \$20 List carton break charge will be applied for orders with only one or two chairs.
- Chairs stack up to 4-high standing or 5 with dolly. Please note that dolly is not recommended for caster models.
- 300 lb. weight capacity.
- All dimensions are nominal.
- Refer to terms and conditions for general information regarding fabrics, finishes, warranty, freight, complete condition of sales and more.

STANDARD METAL ARM/FRAME FINISH COLORS:

- 0405 Charcoal Grey
- 0535 Metallic Silver
- 0199 Chrome (frame only)
- 0299 Polished Aluminum (arm only)
- 0630 Satin Black

PREMIUM METAL ARM/FRAME FINISH COLORS:

- 0605 Matte Black
- 0705 Matte Cotton
- 0788 Glossy Cotton
- 0805 Oasis
- 0905 Mint
- 1005 Mercury
- 1105 Canary
- 1205 Stone
- 1305 Sage
- 1405 Ice Blue
- 1505 Clay

POLYPROPYLENE BACK/ARM COLORS:



- 136 Studio White
- 137 Simply Black
- 138 Soft Grey
- 139 Charcoal

All shipments for this series will be blanket-wrapped as standard. For customers located in Territory 1 who require cartoning, a 5% upcharge will be added to each product. Please contact client services for additional information.

FACTION GUEST | Designed by 5d Studio

ORDERING REQUIREMENTS:

- Model number
- Arm finish, as applicable
- Frame finish
- Upholstery selection
- Options, as applicable

MODEL	PRODUCT SPECIFICATIONS	FABRIC GRADES										LEATHER	
		COM	A	1	2	3	4	COL 5	6	7	8	L1	L2
18111-U 	Guest Chair, Upholstered Back, Armless, Glides 20.75" W x 22" D x 33" H Seat: 18" W x 19" D Seat Ht: 18" COM: 1.25 yds. COL: 25 sq. ft. 23 lbs.	877	957	1,001	1,027	1,069	1,114	1,154	1,196	1,237	1,280	1,477	1,620
18121-U 	Guest Chair, Upholstered Back, Metal Cantilever Arms, Glides 24.75" W x 22" D x 33" H Seat: 18" W x 19" D Seat Ht: 18" Arm Ht: 26.75" COM: 1.25 yds. COL: 25 sq. ft. 26 lbs.	1,026	1,106	1,150	1,176	1,218	1,263	1,303	1,345	1,386	1,429	1,626	1,769
18141-U 	Guest Chair, Upholstered Back, Poly Loop Arms, Glides 24.75" W x 22" D x 33" H Seat: 18" W x 19" D Seat Ht: 18" Arm Ht: 26.75" COM: 1.25 yds. COL: 25 sq. ft. 27 lbs.	915	995	1,039	1,065	1,107	1,152	1,192	1,234	1,275	1,318	1,515	1,658

OPTIONS



- PF02 Premium Metal Finish \$101
- VCT04 VCT Tile Glides \$28

All shipments for this series will be blanket-wrapped as standard. For customers located in Territory 1 who require cartoning, a 5% upcharge will be added to each product. Please contact client services for additional information.

FACTION GUEST | Designed by 5d Studio

ORDERING REQUIREMENTS:

- Model number
- Arm finish, as applicable
- Frame finish
- Upholstery selection
- Options, as applicable

MODEL	PRODUCT SPECIFICATIONS	FABRIC GRADES										LEATHER	
		COM	A	1	2	3	4	COL 5	6	7	8	L1	L2
18115-U 	Guest Chair, Upholstered Back, Armless, Casters 20.75" W x 22" D x 33" H Seat: 18" W x 19" D Seat Ht: 18" COM: 1.25 yds. COL: 25 sq. ft. 23 lbs.	870	950	994	1,020	1,062	1,107	1,147	1,189	1,230	1,273	1,470	1,613
18125-U 	Guest Chair, Upholstered Back, Metal Cantilever Arms, Casters 24.75" W x 22" D x 33" H Seat: 18" W x 19" D Seat Ht: 18" Arm Ht: 26.75" COM: 1.25 yds. COL: 25 sq. ft. 26 lbs.	1,019	1,099	1,143	1,169	1,211	1,256	1,296	1,338	1,379	1,422	1,619	1,762
18145-U 	Guest Chair, Upholstered Back, Poly Loop Arms, Casters 24.75" W x 22" D x 33" H Seat: 18" W x 19" D Seat Ht: 18" Arm Ht: 26.75" COM: 1.25 yds. COL: 25 sq. ft. 28 lbs.	933	1,013	1,057	1,083	1,125	1,170	1,210	1,252	1,293	1,336	1,533	1,676

OPTIONS



- PF02 Premium Metal Finish \$101
- STC02 Soft Tread Casters \$33

All shipments for this series will be blanket-wrapped as standard. For customers located in Territory 1 who require cartoning, a 5% upcharge will be added to each product. Please contact client services for additional information.

FACTION GUEST | Designed by 5d Studio

ORDERING REQUIREMENTS:

- Model number
- Poly back color
- Arm finish, as applicable
- Frame finish
- Upholstery selection
- Options, as applicable

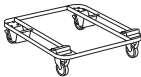
MODEL	PRODUCT SPECIFICATIONS	FABRIC GRADES								LEATHER			
		COM	A	1	2	3	4	COL 5	6	7	8	L1	L2
18111-P 	Guest Chair, Poly Back Armless, Glides 20.75" W x 22" D x 33" H Seat: 18" W x 19" D Seat Ht: 18" COM: .75 yd. COL: 15 sq. ft. 22 lbs.	781	829	856	871	896	923	947	973	997	1,023	1,141	1,227
18121-P 	Guest Chair, Poly Back Metal Cantilever Arms, Glides 24.75" W x 22" D x 33" H Seat: 18" W x 19" D Seat Ht: 18" Arm Ht: 26.75" COM: .75 yd. COL: 15 sq. ft. 25 lbs.	930	978	1,005	1,020	1,045	1,072	1,096	1,122	1,146	1,172	1,290	1,376
18141-P 	Guest Chair, Poly Back Poly Loop Arms, Glides 24.75" W x 22" D x 33" H Seat: 18" W x 19" D Seat Ht: 18" Arm Ht: 26.75" COM: .75 yd. COL: 15 sq. ft. 27 lbs.	816	864	891	906	931	958	982	1,008	1,032	1,058	1,176	1,262
1800 	Dolly (Black Finish Only) 24" W x 30" D x 6" H 37 lbs.	422											

OPTIONS

- PF02 Premium Metal Finish \$101
- VCT04 VCT Tile Glides \$28



 = Available on quick-ship program (0535 Metallic Silver and 0199 Chrome frame finishes, model 18121-P 0299 Polished Aluminum arms only).

All shipments for this series will be blanket-wrapped as standard. For customers located in Territory 1 who require cartoning, a 5% upcharge will be added to each product. Please contact client services for additional information.

FACTION GUEST | Designed by 5d Studio

ORDERING REQUIREMENTS:

- Model number
- Poly back color
- Arm finish, as applicable
- Frame finish
- Upholstery selection
- Options, as applicable

MODEL	PRODUCT SPECIFICATIONS	FABRIC GRADES										LEATHER	
		COM	A	1	2	3	4	COL 5	6	7	8	L1	L2
18115-P	 <p>Guest Chair, Poly Back Armless, Casters 20.75" W x 22" D x 33" H Seat: 18" W x 19" D Seat Ht: 18" COM: .75 yd. COL: 15 sq. ft. 22 lbs.</p>	775	823	850	865	890	917	941	967	991	1,017	1,135	1,221
18125-P	 <p>Guest Chair, Poly Back Metal Cantilever Arms, Casters 24.75" W x 22" D x 33" H Seat: 18" W x 19" D Seat Ht: 18" Arm Ht: 26.75" COM: .75 yd. COL: 15 sq. ft. 25 lbs.</p>	924	972	999	1,014	1,039	1,066	1,090	1,116	1,140	1,166	1,284	1,370
18145-P	 <p>Guest Chair, Poly Back Poly Loop Arms, Casters 24.75" W x 22" D x 33" H Seat: 18" W x 19" D Seat Ht: 18" Arm Ht: 26.75" COM: .75 yd. COL: 15 sq. ft. 27 lbs.</p>	838	886	913	928	953	980	1,004	1,030	1,054	1,080	1,198	1,284

OPTIONS

- PF02 Premium Metal Finish \$101
- STC02 Soft Tread Casters \$33



 = Available on quick-ship program (0535 Metallic Silver and 0199 Chrome frame finishes, model 18125-P 0299 Polished Aluminum arms only).

All shipments for this series will be blanket-wrapped as standard. For customers located in Territory 1 who require cartoning, a 5% upcharge will be added to each product. Please contact client services for additional information.

FACTION NESTING | Designed by 5d Studio

ORDERING REQUIREMENTS:

- Model number
- Arm finish, as applicable
- Frame finish
- Upholstery selection
- Options, as applicable

MODEL	PRODUCT SPECIFICATIONS	FABRIC GRADES								LEATHER			
		COM	A	1	2	3	4	COL 5	6	7	8	L1	L2
18715-U 	Nesting Chair, Fully Upholstered Armless, Casters 20.75" W x 22" D x 33" H Seat: 18" W x 19" D Seat Ht: 18" COM: 1.25 yds. COL: 25 sq. ft. 18 lbs.	919	999	1,043	1,069	1,111	1,156	1,196	1,238	1,279	1,322	1,519	1,662
18725-U 	Nesting Chair, Fully Upholstered Metal Cantilever Arms, Casters 24.75" W x 22" D x 33" H Seat: 18" W x 19" D Seat Ht: 18" Arm Ht: 26.75" COM: 1.25 yds. COL: 25 sq. ft. 21 lbs.	1,068	1,148	1,192	1,218	1,260	1,305	1,345	1,387	1,428	1,471	1,668	1,811

OPTIONS NESTING DIMENSIONS

- PF02 Premium Metal Finish \$101
- STC02 Soft Tread Casters \$33

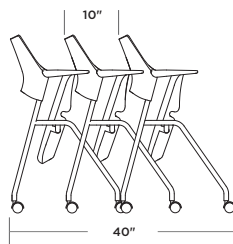



All shipments for this series will be blanket-wrapped as standard. For customers located in Territory 1 who require cartoning, a 5% upcharge will be added to each product. Please contact client services for additional information.

FACTION NESTING | Designed by 5d Studio

ORDERING REQUIREMENTS:

- Model number
- Poly back color
- Arm finish, as applicable
- Frame finish
- Upholstery selection
- Options, as applicable

MODEL	PRODUCT SPECIFICATIONS	FABRIC GRADES								LEATHER			
		COM	A	1	2	3	4	COL 5	6	7	8	L1	L2
18715-P 	Nesting Chair, Poly Back Armless, Casters 20.75" W x 22" D x 33" H Seat: 18" W x 19" D Seat Ht: 18" COM: .75 yd. COL: 15 sq. ft. 17 lbs.	821	869	896	911	936	963	987	1,013	1,037	1,063	1,181	1,267
18725-P 	Nesting Chair, Poly Back Metal Cantilever Arms, Casters 24.75" W x 22" D x 33" H Seat: 18" W x 19" D Seat Ht: 18" Arm Ht: 26.75" COM: .75 yd. COL: 15 sq. ft. 20 lbs.	970	1,018	1,045	1,060	1,085	1,112	1,136	1,162	1,186	1,212	1,330	1,416

OPTIONS NESTING DIMENSIONS

- PF02 Premium Metal Finish \$101
- STC02 Soft Tread Casters \$33

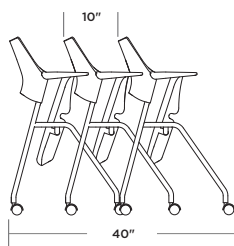

 = Available on quick-ship program (0535 Metallic Silver and 0199 Chrome frame finishes with 0299 Polished Aluminum arms only).

All shipments for this series will be cartoned as standard. If blanket-wrapped shipping is required, please contact client services for additional information.

FACTION SWIVEL | Designed by 5d Studio



SPECIFICATIONS:

- Fully upholstered and poly-back models.
- Polypropylene back available in four colors.
- Armless and metal cantilever arm models.
- Arms and frame available in standard and premium finishes. See below for options.
- Arm finish will match frame finish unless specified otherwise.
- For custom finish colors, please contact client services for pricing.
- For armless models, please specify frame finish.
- Two base options: black nylon and polished aluminum.
- Black nylon base option reduces seat height by 1".
- Fixed back height.
- Non-tilt, height adjustable swivel mechanism.
- 300 lb. weight capacity.
- Ships KD (knocked down).
- All dimensions are nominal.
- Refer to terms and conditions for general information regarding fabrics, finishes, warranty, freight, complete condition of sales and more.

STANDARD METAL ARM/FRAME FINISH COLORS:

- 0405 Charcoal Grey
- 0535 Metallic Silver
- 0199 Chrome (frame only)
- 0299 Polished Aluminum (arm only)
- 0630 Satin Black

PREMIUM METAL ARM/FRAME FINISH COLORS:

- 0605 Matte Black
- 0705 Matte Cotton
- 0788 Glossy Cotton
- 0805 Oasis
- 0905 Mint
- 1005 Mercury
- 1105 Canary
- 1205 Stone
- 1305 Sage
- 1405 Ice Blue
- 1505 Clay

POLYPROPYLENE BACK COLORS:



- 136 Studio White
- 137 Simply Black
- 138 Soft Grey
- 139 Charcoal

All shipments for this series will be cartoned as standard. If blanket-wrapped shipping is required, please contact client services for additional information.

FACTION SWIVEL | Designed by 5d Studio

ORDERING REQUIREMENTS:

- Model number
- Arm finish, as applicable
- Frame finish
- Base finish
- Upholstery selection
- Options, as applicable

MODEL	PRODUCT SPECIFICATIONS	BASE FINISH	FABRIC GRADES								LEATHER			
			COM	A	1	2	3	4	COL 5	6	7	8	L1	L2
18113-U 	Fully Upholstered, Armless 20.75" W x 25.25" D x 32.5" - 37" H Seat: 18" W x 19" D Seat Ht: 18" Back: 18" W x 15" H COM: 1.25 yds. COL: 25 sq. ft. 28 lbs.	Black Nylon	1,047	1,127	1,171	1,197	1,239	1,284	1,324	1,366	1,407	1,450	1,647	1,790
		Polished Aluminum	1,234	1,314	1,358	1,384	1,426	1,471	1,511	1,553	1,594	1,637	1,834	1,977
18123-U 	Fully Upholstered, Metal Cantilever Arms 24.75" W x 25.25" D x 32.5" - 37" H Seat: 18" W x 19" D Seat Ht: 18" Back: 18" W x 15" H COM: 1.25 yds. COL: 25 sq. ft. 31 lbs.	Black Nylon	1,196	1,276	1,320	1,346	1,388	1,433	1,473	1,515	1,556	1,599	1,796	1,939
		Polished Aluminum	1,383	1,463	1,507	1,533	1,575	1,620	1,660	1,702	1,743	1,786	1,983	2,126

OPTIONS



-PF02	Premium Metal Finish (arms/frame only)	\$101
-STC02	Soft Tread Casters	\$33
-STLC02	Soft Tread Self-Locking Casters	\$63
-SK01	Stool Kit	\$120

All shipments for this series will be cartoned as standard. If blanket-wrapped shipping is required, please contact client services for additional information.

FACTION SWIVEL | Designed by 5d Studio

ORDERING REQUIREMENTS:

- Model number
- Poly back color
- Arm finish, as applicable
- Frame finish
- Base finish
- Upholstery selection
- Options, as applicable

MODEL	PRODUCT SPECIFICATIONS	BASE FINISH	FABRIC GRADES								LEATHER			
			COM	A	1	2	3	4	COL 5	6	7	8	L1	L2
18113-P 	☉ Poly Back, Armless 20.75" W x 25.25" D x 32.5" - 37" H Seat: 18" W x 19" D Seat Ht: 18" Back: 18" W x 15" H COM: .75 yd. COL: 15 sq. ft. 27 lbs.	Black Nylon	971	1,019	1,046	1,061	1,086	1,113	1,137	1,163	1,187	1,213	1,331	1,417
		Polished Aluminum	1,158	1,206	1,233	1,248	1,273	1,300	1,324	1,350	1,374	1,400	1,518	1,604
18123-P 	☉ Poly Back, Metal Cantilever Arms 24.75" W x 25.25" D x 32.5" - 37" H Seat: 18" W x 19" D Seat Ht: 18" Back: 18" W x 15" H COM: .75 yd. COL: 15 sq. ft. 30 lbs.	Black Nylon	1,120	1,168	1,195	1,210	1,235	1,262	1,286	1,312	1,336	1,362	1,480	1,566
		Polished Aluminum	1,307	1,355	1,382	1,397	1,422	1,449	1,473	1,499	1,523	1,549	1,667	1,753

OPTIONS

-PF02	Premium Metal Finish (arms/frame only)	\$101
-STC02	Soft Tread Casters	\$33
-STLC02	Soft Tread Self-Locking Casters	\$63
-SK01	Stool Kit	\$120

☉ = Available on quick-ship program (O199 Chrome frame finish with O299 Polished Aluminum arms only).

All shipments for this series will be cartoned as standard. If blanket-wrapped shipping is required, please contact client services for additional information.

FACTION SWIVEL | Designed by 5d Studio

UPHOLSTERY COMBINATIONS:

- For upholstery combinations, refer to the pricing below.
- When combining two COM/COV/COL fabrics, or fabrics with the same grade, add \$120 List per unit.
- When combining three or more COM/COV/COL fabrics, or fabrics with the same grade, add \$150 List per unit.
- When combining different grades of fabric, price will be based on the highest grade specified.
- Two-tone upholstery examples and yardage requirements for the most common combinations are listed below. Additional combinations available; please contact client services for yardage requirements and pricing.
- Note: Yardage amounts are based on fabric which is plain (i.e. non-directional) and a full 54" wide.
- Appropriate upholstery code must be included.

Code	FC1
<u>Model</u>	<u>COM Requirement</u>
All Fully Upholstered Models	Seat = .75 yd. Back = .75 yd.

All shipments for this series will be blanket-wrapped as standard. For customers located in Territory 1 who require cartoning, a 5% upcharge will be added to each product. Please contact client services for additional information.

FLING® GUEST | Designed by 5d Studio



SPECIFICATIONS:

- 4-leg base available in standard and premium finishes. See below for options.
- For custom finish colors, please contact client services for pricing.
- 300 lb. weight capacity.
- All dimensions are nominal.
- Refer to terms and conditions for general information regarding fabrics, finishes, warranty, freight, complete condition of sales and more.

STANDARD METAL BASE FINISH COLORS:

- 0405 Charcoal Grey
- 0535 Metallic Silver
- 0199 Chrome
- 0630 Satin Black

PREMIUM METAL BASE FINISH COLORS:

- 0605 Matte Black
- 0705 Matte Cotton
- 0788 Glossy Cotton
- 0805 Oasis
- 0905 Mint
- 1005 Mercury
- 1105 Canary
- 1205 Stone
- 1305 Sage
- 1405 Ice Blue
- 1505 Clay

All shipments for this series will be blanket-wrapped as standard. For customers located in Territory 1 who require cartoning, a 5% upcharge will be added to each product. Please contact client services for additional information.

FLING® GUEST | Designed by 5d Studio

ORDERING REQUIREMENTS:

- Model number
- Base finish
- Upholstery selection
- Options, as applicable

MODEL	PRODUCT SPECIFICATIONS	FABRIC GRADES								LEATHER			
		COM	A	1	2	3	4	COL 5	6	7	8	L1	L2
2110-U 	Guest Chair, 4-Leg Base 23.75" W x 24" D x 30.25" H Seat: 19" W x 19" D Seat Ht: 17.5" COM: 2.75 yds. COL: 55 sq. ft. 20 lbs.	1,294	1,470	1,567	1,624	1,715	1,814	1,902	1,996	2,086	2,180	2,614	2,928

OPTIONS

-PF02	Premium Metal Base Finish	\$101
-VCT04	VCT Tile Glides	\$28

All shipments for this series will be blanket-wrapped as standard. For customers located in Territory 1 who require cartoning, a 5% upcharge will be added to each product. Please contact client services for additional information.

FLING® GUEST | Designed by 5d Studio

UPHOLSTERY COMBINATIONS:

- For upholstery combinations, refer to the pricing below.
- When combining two COM/COV/COL fabrics, or fabrics with the same grade, add \$120 List per unit.
- When combining three or more COM/COV/COL fabrics, or fabrics with the same grade, add \$150 List per unit.
- When combining different grades of fabric, price will be based on the highest grade specified.
- Two-tone upholstery examples and yardage requirements for the most common combinations are listed below. Additional combinations available; please contact client services for yardage requirements and pricing.
- Note: Yardage amounts are based on fabric which is plain (i.e. non-directional) and a full 54" wide.
- Appropriate upholstery code must be included.



Code **FG2**

Model COM Requirement

2110-U Inside/Outside Back = 1 yd.
Balance of Chair = 1.5 yds.



Code **FG3**

Model COM Requirement

2110-U Inside/Outside Back & Seat Cushion = 1.75 yds.
Balance of Chair = 2.25 yds.



Code **FG4**

Model COM Requirement

2110-U Seat Cushion Only = .75 yd.
Balance of Chair = 2.5 yds.

All shipments for this series will be blanket-wrapped as standard. For customers located in Territory 1 who require cartoning, a 5% upcharge will be added to each product. Please contact client services for additional information.

FLING® LOUNGE | Designed by 5d Studio

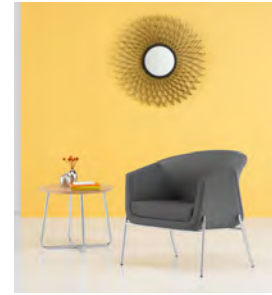

SPECIFICATIONS:

- 4-leg base available in standard and premium finishes. See below for options.
- For custom finish colors, please contact client services for pricing.
- 300 lb. weight capacity.
- All dimensions are nominal.
- Refer to terms and conditions for general information regarding fabrics, finishes, warranty, freight, complete condition of sales and more.

STANDARD METAL BASE FINISH COLORS:

- 0405 Charcoal Grey
- 0535 Metallic Silver
- 0199 Chrome
- 0630 Satin Black

PREMIUM METAL BASE FINISH COLORS:

- 0605 Matte Black
- 0705 Matte Cotton
- 0788 Glossy Cotton
- 0805 Oasis
- 0905 Mint
- 1005 Mercury
- 1105 Canary
- 1205 Stone
- 1305 Sage
- 1405 Ice Blue
- 1505 Clay

All shipments for this series will be blanket-wrapped as standard. For customers located in Territory 1 who require cartoning, a 5% upcharge will be added to each product. Please contact client services for additional information.

FLING® LOUNGE | Designed by 5d Studio

ORDERING REQUIREMENTS:

- Model number
- Base finish
- Upholstery selection
- Options, as applicable

MODEL	PRODUCT SPECIFICATIONS	FABRIC GRADES								LEATHER			
		COM	A	1	2	3	4	COL 5	6	7	8	L1	L2
2170-U 	Lounge Chair, 4-Leg Base 28.5" W x 27.75" D x 30" H Seat: 22" W x 20" D Seat Ht: 17" COM: 3.75 yds. COL: 75 sq. ft. 28 lbs.	1,744	1,984	2,116	2,194	2,318	2,453	2,573	2,701	2,824	2,952	3,544	3,972

OPTIONS

- | | | |
|--------|---------------------------|-------|
| -PF02 | Premium Metal Base Finish | \$101 |
| -VCT04 | VCT Tile Glides | \$28 |

All shipments for this series will be blanket-wrapped as standard. For customers located in Territory 1 who require cartoning, a 5% upcharge will be added to each product. Please contact client services for additional information.

FLING® LOUNGE | Designed by 5d Studio

UPHOLSTERY COMBINATIONS:

- For upholstery combinations, refer to the pricing below.
- When combining two COM/COV/COL fabrics, or fabrics with the same grade, add \$120 List per unit.
- When combining three or more COM/COV/COL fabrics, or fabrics with the same grade, add \$150 List per unit.
- When combining different grades of fabric, price will be based on the highest grade specified.
- Two-tone upholstery examples and yardage requirements for the most common combinations are listed below. Additional combinations available; please contact client services for yardage requirements and pricing.
- Note: Yardage amounts are based on fabric which is plain (i.e. non-directional) and a full 54" wide.
- Appropriate upholstery code must be included.



Code FL2

Model COM Requirement

2170-U Inside/Outside Back = 1.25 yds.
Balance of Chair = 2 yds.



Code FL3

Model COM Requirement

2170-U Inside/Outside Back & Seat Cushion = 2.25 yds.
Balance of Chair = 3 yds.



Code FL4

Model COM Requirement

2170-U Seat Cushion Only = 1 yd.
Balance of Chair = 3.25 yds.

All shipments for this series will be blanket-wrapped as standard. For customers located in Territory 1 who require cartoning, a 5% upcharge will be added to each product. Please contact client services for additional information.

GOGO BENCHES | Designed by Qdesign



PRODUCT FEATURES:



- Single seat and two-seat models.
- Single seat models offered with casters or glides. Two-seat models available with glides only.
- Single seat feature 300 lb. weight capacity.
- Two-seat feature 600 lb. weight capacity.
- All dimensions are nominal.
- Refer to terms and conditions for general information regarding fabrics, finishes, warranty, freight, complete condition of sales and more.

All shipments for this series will be blanket-wrapped as standard. For customers located in Territory 1 who require cartoning, a 5% upcharge will be added to each product. Please contact client services for additional information.

GOGO BENCHES | Designed by Qdesign

ORDERING REQUIREMENTS:

- Model number
- Upholstery selection
- Options, as applicable

MODEL	PRODUCT SPECIFICATIONS	FABRIC GRADES										LEATHER	
		COM	A	1	2	3	4	COL 5	6	7	8	L1	L2
6750 	Single Seat Bench, Glides Overall: 24" W x 22.5" D x 16.75 H" COM: 2.25 yds. COL: 45 sq. ft. 20 lbs.	1,095	1,239	1,318	1,365	1,440	1,521	1,593	1,669	1,743	1,820	2,175	2,432
6755 	Single Seat Bench, Casters Overall: 24" W x 22.5" D x 16.75 H" COM: 2.25 yds. COL: 45 sq. ft. 20 lbs.	1,095	1,239	1,318	1,365	1,440	1,521	1,593	1,669	1,743	1,820	2,175	2,432
6760 	2-Seat Bench, Glides Overall: 48" W x 22.5" D x 16.75 H" COM: 3 yds. COL: 60 sq. ft. 33 lbs.	1,946	2,138	2,243	2,306	2,405	2,513	2,609	2,711	2,810	2,912	3,386	3,728

OPTIONS

-FG04 Felt Glides \$26

GOGO BENCHES | Designed by Qdesign

UPHOLSTERY COMBINATIONS:

- For upholstery combinations, refer to the pricing below.
- When combining two COM/COV/COL fabrics, or fabrics with the same grade, add \$120 List per unit.
- When combining three or more COM/COV/COL fabrics, or fabrics with the same grade, add \$150 List per unit.
- When combining different grades of fabric, price will be based on the highest grade specified.
- Two-tone upholstery examples and yardage requirements for the most common combinations are listed below. Additional combinations available; please contact client services for yardage requirements and pricing.
- Note: Yardage amounts are based on fabric which is plain (i.e. non-directional) and a full 54" wide.
- Appropriate upholstery code must be included.

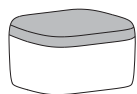

Code	GG9
<u>Model</u>	<u>COM Requirement</u>
6750	Seat Cushion = 1 yd.
6755	Balance of Bench = 1.25 yds.

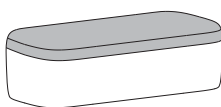

Code	GG10
<u>Model</u>	<u>COM Requirement</u>
6760	Seat Cushion = 1.25 yds.
	Balance of Bench = 1.75 yds.

All shipments for this series will be blanket-wrapped as standard. For customers located in Territory 1 who require cartoning, a 5% upcharge will be added to each product. Please contact client services for additional information.

GOGO LOUNGE | Designed by Qdesign



PRODUCT FEATURES:

- Arm and armless lounge and love seat models.
- Lounge chairs offered with casters or glides. Love seats available with glides only.
- Caster/glide combination also offered to limit movement while seated, but still allow for easy maneuverability when not in use.
- Optional leather pull handle on lounge models (not available on love seats).
- Pull handle is offered in four standard leather color options. Please refer to listing below.
- Lounge chairs feature 300 lb. weight capacity.
- Love seats feature 600 lb. weight capacity.
- All dimensions are nominal.
- Refer to terms and conditions for general information regarding fabrics, finishes, warranty, freight, complete condition of sales and more.

STANDARD LEATHER PULL HANDLE COLORS:

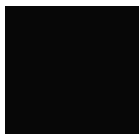

Black



Bright White

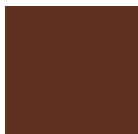

Saddle



Stone Grey









All shipments for this series will be blanket-wrapped as standard. For customers located in Territory 1 who require cartoning, a 5% upcharge will be added to each product. Please contact client services for additional information.

GOGO LOUNGE | Designed by Qdesign

ORDERING REQUIREMENTS:

- Model number
- Upholstery selection
- Options, as applicable

Note: caster/glide combination limits movement while seated, but still allows for easy maneuverability when not in use.

MODEL	PRODUCT SPECIFICATIONS	FABRIC GRADES										LEATHER	
		COM	A	1	2	3	4	COL 5	6	7	8	L1	L2
6710 	 Lounge Chair, Armless, Glides 24" W x 27.25" D x 32" H Seat: 23.25" W x 18.25" D Seat Ht: 16.75" COM: 3 yds. COL: 60 sq. ft. 42 lbs.	1,586	1,778	1,883	1,946	2,045	2,153	2,249	2,351	2,450	2,552	3,026	3,368
6715 	 Lounge Chair, Armless, Casters 24" W x 27.25" D x 32" H Seat: 23.25" W x 18.25" D Seat Ht: 16.75" COM: 3 yds. COL: 60 sq. ft. 42 lbs.	1,586	1,778	1,883	1,946	2,045	2,153	2,249	2,351	2,450	2,552	3,026	3,368
6712 	 Lounge Chair, Armless, Casters/Glides 24" W x 27.25" D x 32" H Seat: 23.25" W x 18.25" D Seat Ht: 16.75" COM: 3 yds. COL: 60 sq. ft. 42 lbs.	1,586	1,778	1,883	1,946	2,045	2,153	2,249	2,351	2,450	2,552	3,026	3,368
6711 	Lounge Chair, Arms, Glides 28.5" W x 29.25" D x 32" H Seat: 23.25" W x 18.25" D Seat Ht: 16.75" COM: 5.5 yds. COL: 110 sq. ft. 72 lbs.	2,067	2,419	2,612	2,727	2,909	3,107	3,283	3,470	3,651	3,838	4,707	5,334
6716 	Lounge Chair, Arms, Casters 28.5" W x 29.25" D x 32" H Seat: 23.25" W x 18.25" D Seat Ht: 16.75" COM: 5.5 yds. COL: 110 sq. ft. 72 lbs.	2,067	2,419	2,612	2,727	2,909	3,107	3,283	3,470	3,651	3,838	4,707	5,334
6717 	Lounge Chair, Arms, Casters/Glides 28.5" W x 29.25" D x 32" H Seat: 23.25" W x 18.25" D Seat Ht: 16.75" COM: 5.5 yds. COL: 110 sq. ft. 72 lbs.	2,067	2,419	2,612	2,727	2,909	3,107	3,283	3,470	3,651	3,838	4,707	5,334

OPTIONS

-P03-BW	Leather Pull Handle, Bright White	\$121	-P03-B	Leather Pull Handle, Black	\$121
-P03-S	Leather Pull Handle, Saddle	\$121	-FG04	Felt Glides	\$26
-P03-SG	Leather Pull Handle, Stone Grey	\$121			

 = Available on quick-ship program.

All shipments for this series will be blanket-wrapped as standard. For customers located in Territory 1 who require cartoning, a 5% upcharge will be added to each product. Please contact client services for additional information.

GOGO LOUNGE | Designed by Qdesign

ORDERING REQUIREMENTS:

- Model number
- Upholstery selection
- Options, as applicable

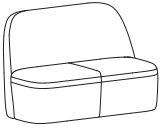
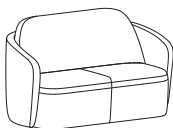
MODEL	PRODUCT SPECIFICATIONS	FABRIC GRADES								LEATHER			
		COM	A	1	2	3	4	COL 5	6	7	8	L1	L2
6720 	Love Seat, Armless, Glides 48" W x 27.25" D x 32" H Seat: 47.5" W x 18.25" D Seat Ht: 16.75" COM: 5 yds. COL: 100 sq. ft. 60 lbs.	2,366	2,686	2,861	2,966	3,131	3,311	3,471	3,641	3,806	3,976	4,766	5,336
6721 	Love Seat, Arms, Glides 53" W x 29.25" D x 32" H Seat: 47.5" W x 18.25" D Seat Ht: 16.75" COM: 9 yds. COL: 180 sq. ft. 103 lbs.	3,025	3,665	4,015	4,225	4,555	4,915	5,235	5,575	5,905	6,245	7,825	8,965

OPTIONS

-FG04 Felt Glides \$26

GOGO LOUNGE | Two-Tone Upholstery

UPHOLSTERY COMBINATIONS:

- For upholstery combinations, refer to the pricing below.
- When combining two COM/COV/COL fabrics, or fabrics with the same grade, add \$120 List per unit.
- When combining three or more COM/COV/COL fabrics, or fabrics with the same grade, add \$150 List per unit.
- When combining different grades of fabric, price will be based on the highest grade specified.
- Two-tone upholstery examples and yardage requirements for the most common combinations are listed below. Additional combinations available; please contact client services for yardage requirements and pricing.
- Note: Yardage amounts are based on fabric which is plain (i.e. non-directional) and a full 54" wide.
- Appropriate upholstery code must be included.

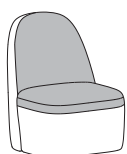

Code GG1

Model COM Requirement

6710 Front of Back & Seat Cushion = 1.25 yds.

6712 Balance of Chair = 2 yds.

6715

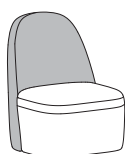

Code GG2

Model COM Requirement

6710 Back Upholstery = 2 yds.

6712 Balance of Chair = 1.5 yds.

6715



Code GG3

Model COM Requirement

6711 Back & Seat Cushion = 2.25 yds.

6716 Balance of Chair = 3.75 yds.

6717

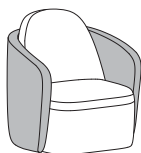

Code GG4

Model COM Requirement

6711 Arm Panels/Outer Shell = 3 yds.

6716 Balance of Chair = 3 yds.

6717

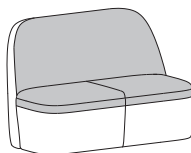

Code GG5

Model COM Requirement

6720 Front of Back & Seat Cushion = 2.25 yds.

Balance of Love Seat = 3 yds.

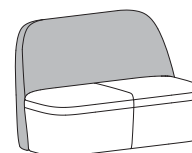

Code GG6

Model COM Requirement

6720 Back Upholstery = 3 yds.

Balance of Love Seat = 2.5 yds.

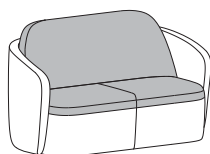

Code GG7

Model COM Requirement

6721 Back & Seat Cushion = 3.75 yds.

Balance of Love Seat = 5.25 yds.

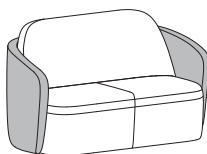

Code GG8

Model COM Requirement

6721 Arm Panels/Outer Shell = 4 yds.

Balance of Love Seat = 5 yds.

HADO BENCHES | Designed by Qdesign



SPECIFICATIONS:

- Square and rectangular benches and ottomans with wood legs.
- Wood legs offered in all standard and custom finishes on Ash.
- For custom wood finishes, please contact client services and add one-time upcharge of \$531 List per color per order.
- For Super Matte Sable Ash finish, upcharge applies. Refer to option section for pricing.
- 22" ottoman and 30" square bench feature 275 lb. weight capacity.
- 36" square bench, 48" rectangular bench and 60" rectangular bench feature 550 lb. weight capacity.
- Ottoman features 7¾" leg height clearance.
- Square and rectangular benches feature 12½" leg height clearance.
- Leg assembly required.
- All dimensions are nominal.
- Refer to terms and conditions for general information regarding fabrics, finishes, warranty, freight, complete condition of sales and more.

MINI-TAP POWER UNITS:

- Available on all benches and ottomans.
- Dimensions: 3" W x 3" D x 1.75" H
- Black and white color options.
- 72" electrical cord (no hardwire option available for this series).
- Placement is located under seat.
- Please specify front, left side or right side placement, as seated.
- For left or right side placement, unit will be centered as standard.
- For front placement, please specify left, center or right, as seated.
- UL listed.

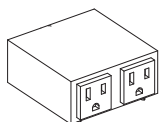

Mini-Tap 2 (MT2)
■ Two outlets.

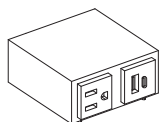



Mini-Tap 3 (MT3)
■ One outlet, one USB-A and one USB-C charging port.

All shipments for this series will be blanket-wrapped as standard. For customers located in Territory 1 who require cartoning, a 5% upcharge will be added to each product. Please contact client services for additional information.

HADO BENCHES | Designed by Qdesign

ORDERING REQUIREMENTS:

- Model number
- Leg finish
- Upholstery selection
- Options, as applicable

MODEL	PRODUCT SPECIFICATIONS	FABRIC GRADES										LEATHER	
		COM	A	1	2	3	4	COL 5	6	7	8	L1	L2
63522 	22" Square Ottoman 22" W x 22" D x 15.75" H COM: 1.25 yds. COL: 25 sq. ft. 19 lbs.	1,173	1,253	1,297	1,323	1,365	1,410	1,450	1,492	1,533	1,576	1,773	1,916
63530 	30" Square Bench 30" W x 30" D x 19" H COM: 1.5 yds. COL: 30 sq. ft. 27 lbs.	1,434	1,530	1,583	1,614	1,664	1,718	1,766	1,817	1,866	1,917	2,154	2,325
63536 	36" Square Bench 36" W x 36" D x 19" H COM: 1.75 yds. COL: 35 sq. ft. 37 lbs.	1,784	1,896	1,958	1,994	2,052	2,115	2,171	2,231	2,288	2,348	2,624	2,824

OPTIONS

-SM01	Super Matte Sable Wood Finish	\$12
-NS04	Non-Skid Glides	\$26
-MT2-()	Mini-Tap Power Unit (2 power)	\$380
-MT3-()	Mini-Tap Power Unit (1 power, 1 USB-A, 1 USB-C)	\$414

Note: please specify (-B) for black and (-W) for white on Mini-Tap Power Units.

 = Available on quick-ship program.

All shipments for this series will be blanket-wrapped as standard. For customers located in Territory 1 who require cartoning, a 5% upcharge will be added to each product. Please contact client services for additional information.

HADO BENCHES | Designed by Qdesign

ORDERING REQUIREMENTS:

- Model number
- Leg finish
- Upholstery selection
- Options, as applicable

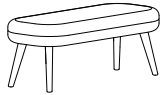
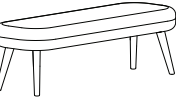
MODEL	PRODUCT SPECIFICATIONS	FABRIC GRADES										LEATHER	
		COM	A	1	2	3	4	COL 5	6	7	8	L1	L2
63548 	48" Rectangular Bench 48" W x 20" D x 19" H COM: 2 yds. COL: 40 sq. ft. 38 lbs.	1,750	1,878	1,948	1,990	2,056	2,128	2,192	2,260	2,326	2,394	2,710	2,938
63560 	60" Rectangular Bench 60" W x 20" D x 19" H COM: 2.75 yds. COL: 55 sq. ft. 45 lbs.	1,796	1,972	2,069	2,126	2,217	2,316	2,404	2,498	2,588	2,682	3,116	3,430

OPTIONS

-SM01	Super Matte Sable Wood Finish	\$12
-NS04	Non-Skid Glides	\$26
-MT2-()	Mini-Tap Power Unit (2 power)	\$380
-MT3-()	Mini-Tap Power Unit (1 power, 1 USB-A, 1 USB-C)	\$414

Note: please specify (-B) for black and (-W) for white on Mini-Tap Power Units.

 = Available on quick-ship program.

HADO BENCHES | Designed by Qdesign

UPHOLSTERY COMBINATIONS:

- For upholstery combinations, refer to the pricing below.
- When combining two COM/COV/COL fabrics, or fabrics with the same grade, add \$120 List per unit.
- When combining three or more COM/COV/COL fabrics, or fabrics with the same grade, add \$150 List per unit.
- When combining different grades of fabric, price will be based on the highest grade specified.
- Two-tone upholstery examples and yardage requirements for the most common combinations are listed below. Additional combinations available; please contact client services for yardage requirements and pricing.
- Note: Yardage amounts are based on fabric which is plain (i.e. non-directional) and a full 54" wide.
- Appropriate upholstery code must be included.



Code **HB1**
Model COM Requirement
 63522 Upholstered Platform = .5 yd.
 Balance of Bench = .75 yd.



Code **HB2**
Model COM Requirement
 63530 Upholstered Platform = .5 yd.
 Balance of Bench = 1 yd.



Code **HB3**
Model COM Requirement
 63536 Upholstered Platform = .5 yd.
 Balance of Bench = 1 yd.

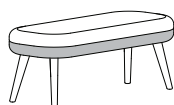

Code **HB4**
Model COM Requirement
 63548 Upholstered Platform = .75 yd.
 Balance of Bench = 1.25 yds.

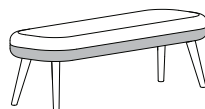

Code **HB5**
Model COM Requirement
 63560 Upholstered Platform = 1 yd.
 Balance of Bench = 2 yds.

All shipments for this series will be blanket-wrapped as standard. For customers located in Territory 1 who require cartoning, a 5% upcharge will be added to each product. Please contact client services for additional information.

HADO GUEST | Designed by Qdesign



SPECIFICATIONS:

- Two base options: 4-leg metal and 4-leg wood.
- Metal legs available in standard and premium finishes. See below for options.
- For custom finish colors, please contact client services for pricing.
- Wood legs offered in all standard and custom finishes on Ash.
- For custom wood finishes, please contact client services and add one-time upcharge of \$531 List per color per order.
- For Super Matte Sable Ash finish, upcharge applies. Refer to option section for pricing.
- 300 lb. weight capacity.
- All dimensions are nominal.
- Refer to terms and conditions for general information regarding fabrics, finishes, warranty, freight, complete condition of sales and more.

STANDARD METAL LEG FINISH COLORS:

- 0405 Charcoal Grey
- 0535 Metallic Silver
- 0199 Chrome
- 0630 Satin Black

PREMIUM METAL LEG FINISH COLORS:



- 0605 Matte Black
- 0705 Matte Cotton
- 0788 Glossy Cotton
- 0805 Oasis
- 0905 Mint
- 1005 Mercury
- 1105 Canary
- 1205 Stone
- 1305 Sage
- 1405 Ice Blue
- 1505 Clay

All shipments for this series will be blanket-wrapped as standard. For customers located in Territory 1 who require cartoning, a 5% upcharge will be added to each product. Please contact client services for additional information.

HADO GUEST | Designed by Qdesign

ORDERING REQUIREMENTS:

- Model number
- Leg finish
- Upholstery selection
- Options, as applicable

MODEL	PRODUCT SPECIFICATIONS	FABRIC GRADES								LEATHER			
		COM	A	1	2	3	4	COL 5	6	7	8	L1	L2
63111 	Guest Chair, 4-Leg Metal Base 18" W x 23.5" D x 31.5" H Seat: 18" W x 17.5" D Seat Ht: 17.5" COM: 1.5 yds. COL: 30 sq. ft. 16 lbs.	1,305	1,401	1,454	1,485	1,535	1,589	1,637	1,688	1,737	1,788	2,025	2,196
63114 	Guest Chair, 4-Leg Wood Base 18" W x 23.5" D x 31.5" H Seat: 18" W x 17.5" D Seat Ht: 17.5" COM: 1.5 yds. COL: 30 sq. ft. 16 lbs.	1,479	1,575	1,628	1,659	1,709	1,763	1,811	1,862	1,911	1,962	2,199	2,370

OPTIONS

-PF02	Premium Metal Leg Finish	\$101
-SM02	Super Matte Sable Wood Finish	\$23
-NS04	Non-Skid Glides	\$26

All shipments for this series will be blanket-wrapped as standard. For customers located in Territory 1 who require cartoning, a 5% upcharge will be added to each product. Please contact client services for additional information.

HADO GUEST | Designed by Qdesign

UPHOLSTERY COMBINATIONS:

- For upholstery combinations, refer to the pricing below.
- When combining two COM/COV/COL fabrics, or fabrics with the same grade, add \$120 List per unit.
- When combining three or more COM/COV/COL fabrics, or fabrics with the same grade, add \$150 List per unit.
- When combining different grades of fabric, price will be based on the highest grade specified.
- Two-tone upholstery examples and yardage requirements for the most common combinations are listed below. Additional combinations available; please contact client services for yardage requirements and pricing.
- Note: Yardage amounts are based on fabric which is plain (i.e. non-directional) and a full 54" wide.
- Appropriate upholstery code must be included.



Code	HG1
<u>Model</u>	<u>COM Requirement</u>
All Models	Seat = 1 yd. Back = .75 yd.

All shipments for this series will be blanket-wrapped as standard. For customers located in Territory 1 who require cartoning, a 5% upcharge will be added to each product. Please contact client services for additional information.

HADO LOUNGE | Designed by Qdesign



SPECIFICATIONS:

- Lounge and love seat models available with wood or metal legs.
- Wood legs offered in all standard and custom finishes on Ash.
- For custom wood finishes, please contact client services and add one-time upcharge of \$531 List per color per order.
- For Super Matte Sable Ash finish, upcharge applies. Refer to option section for pricing.
- Metal legs available in standard and premium finishes. See below for options.
- For custom metal finish colors, please contact client services for pricing.
- Lounge chair features 350 lb. weight capacity. Love seat and sofa feature 700 lb. weight capacity.
- 7¾" leg height clearance.
- Leg assembly required.
- All dimensions are nominal.
- Refer to terms and conditions for general information regarding fabrics, finishes, warranty, freight, complete condition of sales and more.

STANDARD METAL LEG FINISH COLORS:

- 0405 Charcoal Grey
- 0535 Metallic Silver
- 0630 Satin Black
- Satin Chrome

PREMIUM METAL LEG FINISH COLORS:

- 0605 Matte Black
- 0705 Matte Cotton
- 0788 Glossy Cotton
- 0805 Oasis
- 0905 Mint
- 1005 Mercury
- 1105 Canary
- 1205 Stone
- 1305 Sage
- 1405 Ice Blue
- 1505 Clay

HADO LOUNGE | Designed by Qdesign

MINI-TAP POWER UNITS:

- Available on all lounge models.
- Dimensions: 3" W x 3" D x 1.75" H
- Black and white color options.
- 72" electrical cord (no hardwire option available for this series).
- Placement is located under seat.
- Please specify front, left side or right side placement, as seated.
- For left or right side placement, unit will be centered as standard.
- For front placement, please specify left, center or right, as seated.
- UL listed.

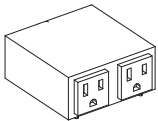

Mini-Tap 2 (MT2)

- Two outlets.

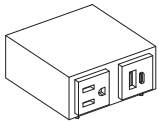

Mini-Tap 3 (MT3)

- One outlet, one USB-A and one USB-C charging port.

POWER MATRIX 1 UNIT (PX1):

- Available on all lounge models.
- One outlet, one USB-A and one USB-C charging port.
- Dimensions: 5.25" L x 2.5" W
- Black and white finish options.
- 120" electrical cord (no hardwire option available for this series).
- Unit will be positioned on right side arm panel, as seated, unless otherwise specified.
- UL listed.

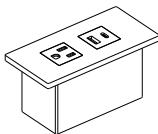





All shipments for this series will be blanket-wrapped as standard. For customers located in Territory 1 who require cartoning, a 5% upcharge will be added to each product. Please contact client services for additional information.

HADO LOUNGE | Designed by Qdesign

ORDERING REQUIREMENTS:

- Model number
- Leg finish
- Upholstery selection
- Options, as applicable

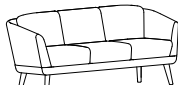
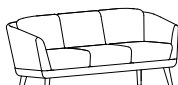
MODEL	PRODUCT SPECIFICATIONS	FABRIC GRADES										LEATHER	
		COM	A	1	2	3	4	COL 5	6	7	8	L1	L2
63224 	Lounge Chair, Wood Legs 33" W x 34.5" D x 29.5" H Seat: 22" W x 21.5" D Seat Ht: 17" COM: 4.5 yds. COL: 90 sq. ft. 67 lbs.	2,499	2,787	2,945	3,039	3,188	3,350	3,494	3,647	3,795	3,948	4,659	5,172
63224-M 	Lounge Chair, Metal Legs 33" W x 34.5" D x 29.5" H Seat: 22" W x 21.5" D Seat Ht: 17" COM: 4.5 yds. COL: 90 sq. ft. 67 lbs.	2,499	2,787	2,945	3,039	3,188	3,350	3,494	3,647	3,795	3,948	4,659	5,172
63324 	Love Seat, Wood Legs 57 W x 34.5" D x 29.5" H Seat: 46" W x 21.5" D Seat Ht: 17" COM: 8.25 yds. COL: 165 sq. ft. 95 lbs.	3,134	3,662	3,951	4,124	4,397	4,694	4,958	5,238	5,510	5,791	7,094	8,035
63324-M 	Love Seat, Metal Legs 57 W x 34.5" D x 29.5" H Seat: 46" W x 21.5" D Seat Ht: 17" COM: 8.25 yds. COL: 165 sq. ft. 95 lbs.	3,134	3,662	3,951	4,124	4,397	4,694	4,958	5,238	5,510	5,791	7,094	8,035
63424 	Sofa, Wood Legs 80" W x 34.5" D x 29.5" H Seat: 69" W x 21.5" D Seat Ht: 17" COM: 10.25 yds. COL: 205 sq. ft. 142 lbs.	4,180	4,836	5,195	5,410	5,749	6,118	6,446	6,794	7,132	7,481	9,100	10,269
63424-M 	Sofa, Metal Legs 80" W x 34.5" D x 29.5" H Seat: 69" W x 21.5" D Seat Ht: 17" COM: 10.25 yds. COL: 205 sq. ft. 142 lbs.	4,180	4,836	5,195	5,410	5,749	6,118	6,446	6,794	7,132	7,481	9,100	10,269

OPTIONS

-PF02	Premium Metal Leg Finish	\$101
-SM01	Super Matte Sable Wood Finish	\$12
-NS04	Non-Skid Glides	\$26
-MT2-()	Mini-Tap Power Unit (2 power)	\$380
-MT3-()	Mini-Tap Power Unit (1 power, 1 USB-A, 1 USB-C)	\$414
-PX1-()	Power Matrix 1 (1 power, 1 USB-A, 1 USB-C)	\$534

Note: please specify (-B) for black and (-W) for white on Mini-Tap Power Units and Power Matrix.

HADO LOUNGE | Designed by Qdesign

UPHOLSTERY COMBINATIONS:

- For upholstery combinations, refer to the pricing below.
- When combining two COM/COV/COL fabrics, or fabrics with the same grade, add \$120 List per unit.
- When combining three or more COM/COV/COL fabrics, or fabrics with the same grade, add \$150 List per unit.
- When combining different grades of fabric, price will be based on the highest grade specified.
- Two-tone upholstery examples and yardage requirements for the most common combinations are listed below. Additional combinations available; please contact client services for yardage requirements and pricing.
- Note: Yardage amounts are based on fabric which is plain (i.e. non-directional) and a full 54" wide.
- Appropriate upholstery code must be included.



Code	HL1
<u>Model</u>	<u>COM Requirement</u>
63224	Upholstered Platform = 1 yd.
63224-M	Balance of Chair = 4.5 yds.

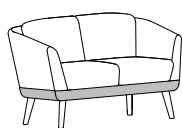

Code	HL2
<u>Model</u>	<u>COM Requirement</u>
63324	Upholstered Platform = 1.25 yds.
63324-M	Balance of Love Seat = 7.25 yds.

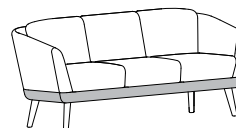

Code	HL3
<u>Model</u>	<u>COM Requirement</u>
63424	Upholstered Platform = 1.25 yds.
63424-M	Balance of Sofa = 9 yds.

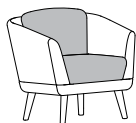

Code	HL4
<u>Model</u>	<u>COM Requirement</u>
63224	Back & Seat Cushion = 1.75 yds.
63224-M	Balance of Chair = 4 yds.

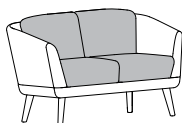

Code	HL5
<u>Model</u>	<u>COM Requirement</u>
63324	Back & Seat Cushion = 4 yds.
63324-M	Balance of Love Seat = 5 yds.

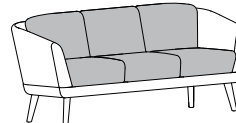

Code	HL6
<u>Model</u>	<u>COM Requirement</u>
63424	Back & Seat Cushion = 5.5 yds.
63424-M	Balance of Sofa = 5.25 yds.

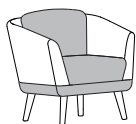

Code	HL7
<u>Model</u>	<u>COM Requirement</u>
63224	Back & Seat Cushion/
63224-M	Upholstered Platform = 3.75 yds.
	Balance of Chair = 2 yds.

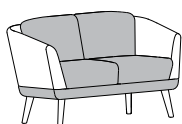

Code	HL8
<u>Model</u>	<u>COM Requirement</u>
63324	Back & Seat Cushion/
63324-M	Upholstered Platform = 2.5 yds.
	Balance of Love Seat = 6.75 yds.

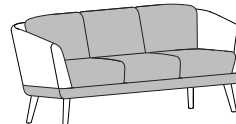

Code	HL9
<u>Model</u>	<u>COM Requirement</u>
63424	Back & Seat Cushion/
63424-M	Upholstered Platform = 2.5 yds.
	Balance of Sofa = 8.25 yds.

All shipments for this series will be blanket-wrapped as standard. For customers located in Territory 1 who require cartoning, a 5% upcharge will be added to each product. Please contact client services for additional information.

HADO MEETING TABLES | Designed by Qdesign



SPECIFICATIONS:

- Round, square and rectangular top shapes.
- Three top surface options: wood veneer, laminate and Fenix.
- Wood veneer tops and wood legs available in all standard and custom finishes on Ash.
- For custom wood finishes, please contact client services and add one-time upcharge of \$531 List per color per order.
- For Super Matte Sable Ash finish, upcharge applies. Refer to option section for pricing.
- For custom laminate options, add \$649 List per color per order. Pre-approval required, please contact client services.
- Fenix offered in five standard colorways.
- For non-standard Fenix colors, please contact client services for pricing.
- For veneer, standard wood grain and solid black laminate, as well as Fenix Nero Ingo (black), edge will match top finish color, unless specified otherwise.
- For all other solid color laminate and Fenix tops, edge to match specified leg finish.
- Leg assembly required.
- All dimensions are nominal.
- Refer to terms and conditions for general information regarding finishes, warranty, freight, complete condition of sales and more.

EDGE DETAIL:

Laminate*/Veneer/Fenix Top

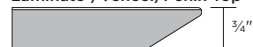

*Please note that laminate thickness is nominal and may vary.

TOP SHAPES:

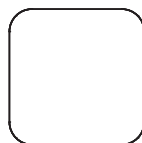
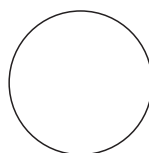



All shipments for this series will be blanket-wrapped as standard. For customers located in Territory 1 who require cartoning, a 5% upcharge will be added to each product. Please contact client services for additional information.

HADO MEETING TABLES | Designed by Qdesign

ORDERING REQUIREMENTS:

- Model number
- Top surface
- Top finish, if applicable
- Leg finish
- Options, as applicable

MODEL	DIMENSIONS	veneer TOP (-V)	laminated TOP (-L)	fenix TOP (-FE)	WEIGHT	
 <p>Round Top</p>	6320-3629-()	36"D x 29"H	3,125	2,860	3,255	37 lbs.
	6320-4229-()	42"D x 29"H	3,317	3,042	3,579	46 lbs.
	6320-4829-()	48"D x 29"H	3,450	3,168	3,870	55 lbs.
 <p>Square Top</p>	6325-363629-()	36"W x 36"D x 29"H	3,241	2,974	3,369	37 lbs.
	6325-424229-()	42"W x 42"D x 29"H	3,422	3,147	3,684	46 lbs.
	6325-484829-()	48"W x 48"D x 29"H	3,560	3,276	3,978	55 lbs.
 <p>Rectangular Top</p>	6325-603029-()	60"W x 30"D x 29"H	3,430	3,154	3,702	48 lbs.
	6325-723029-()	72"W x 30"D x 29"H	4,662	4,216	4,874	53 lbs.
	6325-723629-()	72"W x 36"D x 29"H	4,746	4,301	5,090	58 lbs.

OPTIONS

- SM05 Super Matte Sable Wood Finish \$85
- NS04 Non-Skid Glides \$26

 = Available on quick-ship program.

All shipments for this series will be blanket-wrapped as standard. For customers located in Territory 1 who require cartoning, a 5% upcharge will be added to each product. Please contact client services for additional information.

HADO OCCASIONAL TABLES | Designed by Qdesign



SPECIFICATIONS:

- Round, square and rectangular top shapes.
- Two heights: 16" and 20".
- Five top surface options: wood veneer, laminate, Fenix, solid surface and Starphire® glass.
- Wood veneer tops and wood legs available in all standard and custom finishes on Ash.
- For custom wood finishes, please contact client services and add one-time upcharge of \$531 List per color per order.
- For Super Matte Sable Ash finish, upcharge applies. Refer to option section for pricing.
- For custom laminate options, add \$649 List per color per order. Pre-approval required, please contact client services.
- Fenix offered in five standard colorways.
- For non-standard Fenix colors, please contact client services for pricing.
- For veneer, standard wood grain and solid black laminate, as well as Fenix Nero Ingo (black), edge will match top finish color, unless specified otherwise.
- For all other solid color laminate and Fenix tops, edge to match specified leg finish.
- Glass tops are back-painted white as standard.
- Solid surface available in white only.
- Back-painted glass and solid surface tops feature exposed plywood with a clear coat finish.
- Leg assembly required.
- All dimensions are nominal.
- Refer to terms and conditions for general information regarding finishes, warranty, freight, complete condition of sales and more.

EDGE DETAIL:

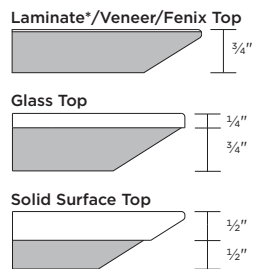

*Please note that laminate thickness is nominal and may vary.

TOP SHAPES:

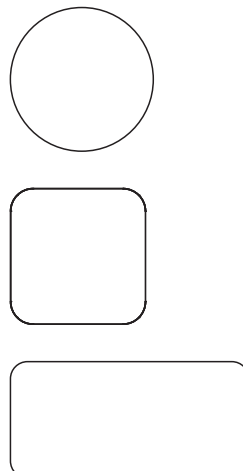



All shipments for this series will be blanket-wrapped as standard. For customers located in Territory 1 who require cartoning, a 5% upcharge will be added to each product. Please contact client services for additional information.

HADO OCCASIONAL TABLES | Designed by Qdesign

ORDERING REQUIREMENTS:

- Model number
- Top surface
- Top finish, if applicable
- Leg finish
- Options, as applicable

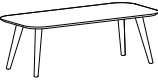
MODEL	VENEER TOP (-V)	LAMINATE TOP (-L)	FENIX TOP (-FE)	SOLID SURFACE TOP (-SF)	BACK-PAINTED GLASS TOP (-GL)	WEIGHT
 Round Top 6320-2116-() 6320-3016-() 6320-3616-() 6320-4216-()	1,288	1,209	1,344	1,444	1,408	18 lbs.
	2,029	1,843	2,117	2,322	2,174	26 lbs.
	2,518	2,253	2,648	3,186	2,649	33 lbs.
	2,632	2,358	2,895	3,626	2,820	42 lbs.
 Square Top 6325-222216-() 6325-303016-() 6325-363616-() 6325-424216-()	1,310	1,230	1,378	1,536	1,428	18 lbs.
	2,052	1,863	2,137	2,342	2,193	26 lbs.
	2,547	2,283	2,678	3,216	2,680	33 lbs.
	2,665	2,390	2,927	3,658	2,852	42 lbs.
 Rectangular Top 6325-482216-()	2,337	2,096	2,418	2,925	2,426	29 lbs.

OPTIONS

- SM04 Super Matte Sable Wood Finish \$46
- NS04 Non-Skid Glides \$26



 = Available on quick-ship program (veneer, laminate, Fenix and solid surface tops only).

All shipments for this series will be blanket-wrapped as standard. For customers located in Territory 1 who require cartoning, a 5% upcharge will be added to each product. Please contact client services for additional information.

HADO OCCASIONAL TABLES | Designed by Qdesign

ORDERING REQUIREMENTS:

- Model number
- Top surface
- Top finish, if applicable
- Leg finish
- Options, as applicable

MODEL	VENEER TOP (-V)	LAMINATE TOP (-L)	FENIX TOP (-FE)	SOLID SURFACE TOP (-SF)	BACK-PAINTED GLASS TOP (-GL)	WEIGHT
 <p>Round Top 6320-2120-()</p>	1,451	1,373	1,508	1,608	1,571	19 lbs.
 <p>Square Top 6325-222220-()</p>	1,483	1,400	1,548	1,706	1,600	19 lbs.

OPTIONS

- SM04 Super Matte Sable Wood Finish \$46
- NS04 Non-Skid Glides \$26

 = Available on quick-ship program (veneer, laminate, Fenix and solid surface tops only).

All shipments for this series will be blanket-wrapped as standard. For customers located in Territory 1 who require cartoning, a 5% upcharge will be added to each product. Please contact client services for additional information.

HOOM GUEST | Designed by Gower + Woolf



SPECIFICATIONS:

- Four base options available: 4-leg wood, 4-leg metal, 4-prong swivel with glides and 5-prong with casters.
- 4-prong swivel base models with glides feature self-return.
- 5-prong base models with casters feature height-adjustable tilt-lock mechanism.
- Metal bases offered in standard and premium finishes. Please refer to listing below.
- For custom metal finish colors, please contact client services for pricing.
- 4-leg wood bases offered in all standard finishes on Ash.
- For Super Matte Sable Ash finish, upcharge applies. Refer to option section for pricing.
- For custom wood finishes, please add \$531 List per color per order.
- 300 lb. weight capacity.
- All dimensions are nominal.
- Refer to terms and conditions for general information regarding fabrics, finishes, warranty, freight, complete condition of sales and more.

STANDARD METAL BASE FINISH COLORS:

- 0405 Charcoal Grey
- 0535 Metallic Silver
- 0199 Chrome (4-leg base only)
- 0299 Polished Aluminum (swivel base only)
- 0630 Satin Black

PREMIUM METAL BASE FINISH COLORS:









- 0605 Matte Black
- 0705 Matte Cotton
- 0788 Glossy Cotton
- 0805 Oasis
- 0905 Mint
- 1005 Mercury
- 1105 Canary
- 1205 Stone
- 1305 Sage
- 1405 Ice Blue
- 1505 Clay

All shipments for this series will be blanket-wrapped as standard. For customers located in Territory 1 who require cartoning, a 5% upcharge will be added to each product. Please contact client services for additional information.

HOOM GUEST | Designed by Gower + Woolf

ORDERING REQUIREMENTS:

- Model number
- Base finish
- Upholstery selection
- Options, as applicable

MODEL	PRODUCT SPECIFICATIONS	FABRIC GRADES										LEATHER	
		COM	A	1	2	3	4	COL 5	6	7	8	L1	L2
7001 	 Guest Chair, 4-Leg Metal Base 24" W x 24" D x 31.5" H Seat: 18.5" W x 18" D Seat Ht: 17.75" COM: 1.75 yds. COL: 35 sq. ft. 24 lbs.	1,258	1,370	1,432	1,468	1,526	1,589	1,645	1,705	1,762	1,822	2,098	2,298
7003-G 	 Guest Chair, 4-Prong Swivel Base, Glides 24" W x 24" D x 31.75" H Seat: 18.5" W x 17.5" D Seat Ht: 18.25" COM: 1.75 yds. COL: 35 sq. ft. 24 lbs.	1,444	1,556	1,618	1,654	1,712	1,775	1,831	1,891	1,948	2,008	2,284	2,484
7003-C 	 Guest Chair, 5-Prong Base, Height-Adjustable Tilt-Lock Mechanism, Casters 24" W x 24" D x 31.25" H Seat: 18.5" W x 17.5" D Seat Ht: 17.75" COM: 1.75 yds. COL: 35 sq. ft. 24 lbs.	1,503	1,615	1,677	1,713	1,771	1,834	1,890	1,950	2,007	2,067	2,343	2,543
7004 	 Guest Chair, 4-Leg Wood Base 24" W x 24" D x 31" H Seat: 18.5" W x 17.5" D Seat Ht: 17.5" COM: 1.75 yds. COL: 35 sq. ft. 26 lbs.	1,492	1,604	1,666	1,702	1,760	1,823	1,879	1,939	1,996	2,056	2,332	2,532

OPTIONS

-PF02	Premium Metal Base Finish	\$101
-SM02	Super Matte Sable Wood Finish	\$23
-NS04	Non-Skid Glides	\$26
-STC02	Soft Tread Casters (model 7003-C only)	\$33
-STLC02	Soft Tread Self-Locking Casters (model 7003-C only)	\$63
-GDO4	Glides (model 7003-C only)	\$30

 = Available on quick-ship program (0535 Metallic Silver, 0199 Chrome, 0299 Polished Aluminum and standard wood base finishes only).

All shipments for this series will be blanket-wrapped as standard. For customers located in Territory 1 who require cartoning, a 5% upcharge will be added to each product. Please contact client services for additional information.

HOOM GUEST | Designed by Gower + Woolf

UPHOLSTERY COMBINATIONS:

- For upholstery combinations, refer to the pricing below.
- When combining two COM/COV/COL fabrics, or fabrics with the same grade, add \$120 List per unit.
- When combining three or more COM/COV/COL fabrics, or fabrics with the same grade, add \$150 List per unit.
- When combining different grades of fabric, price will be based on the highest grade specified.
- Two-tone upholstery examples and yardage requirements for the most common combinations are listed below. Additional combinations available; please contact client services for yardage requirements and pricing.
- Note: Yardage amounts are based on fabric which is plain (i.e. non-directional) and a full 54" wide.
- Appropriate upholstery code must be included.



Code	HM1
<u>Model</u>	<u>COM Requirement</u>
All	Seat Cushion = .75 yd. Balance of Chair = 1.25 yds.

All shipments for this series will be blanket-wrapped as standard. For customers located in Territory 1 who require cartoning, a 5% upcharge will be added to each product. Please contact client services for additional information.

HOOM LOUNGE | Designed by Gower + Woolf



SPECIFICATIONS:

- Two base options available: 4-leg wood and 4-prong swivel base with self-return.
- 4-prong swivel base available with or without rocker mechanism and offered in standard and premium finishes. Please refer to listing below.
- For custom metal finish colors, please contact client services for pricing.
- 4-leg wood base offered in all standard finishes on Ash.
- For custom wood finishes, please add \$531 List per color per order.
- For Super Matte Sable Ash finish, upcharge applies. Refer to option section for pricing.
- 300 lb. weight capacity.
- All dimensions are nominal.
- Refer to terms and conditions for general information regarding fabrics, finishes, warranty, freight, complete condition of sales and more.

STANDARD METAL BASE FINISH COLORS:

- 0405 Charcoal Grey
- 0535 Metallic Silver
- 0299 Polished Aluminum
- 0630 Satin Black

PREMIUM METAL BASE FINISH COLORS:







- 0605 Matte Black
- 0705 Matte Cotton
- 0788 Glossy Cotton
- 0805 Oasis
- 0905 Mint
- 1005 Mercury
- 1105 Canary
- 1205 Stone
- 1305 Sage
- 1405 Ice Blue
- 1505 Clay

All shipments for this series will be blanket-wrapped as standard. For customers located in Territory 1 who require cartoning, a 5% upcharge will be added to each product. Please contact client services for additional information.

HOOM LOUNGE | Designed by Gower + Woolf

ORDERING REQUIREMENTS:

- Model number
- Base finish
- Upholstery selection
- Options, as applicable

MODEL	PRODUCT SPECIFICATIONS	FABRIC GRADES								LEATHER			
		COM	A	1	2	3	4	COL 5	6	7	8	L1	L2
7053 	 Lounge Chair, 4-Prong Swivel Base 26.5" W x 26" D x 29.5" H Seat: 21" W x 18.5" D Seat Ht: 16.75" COM: 2.5 yds. COL: 50 sq. ft. 38 lbs.	1,705	1,865	1,953	2,005	2,088	2,178	2,258	2,343	2,425	2,510	2,905	3,190
7053-RM01 	 Lounge Chair, 4-Prong Swivel Base with Rocker 26.5" W x 26" D x 29.5" H Seat: 21" W x 18.5" D Seat Ht: 16.75" COM: 2.5 yds. COL: 50 sq. ft. 34 lbs.	1,778	1,938	2,026	2,078	2,161	2,251	2,331	2,416	2,498	2,583	2,978	3,263
7054 	 Lounge Chair, 4-Leg Wood Base 26.5" W x 26" D x 29.5" H Seat: 21" W x 18.5" D Seat Ht: 16.5" COM: 2.5 yds. COL: 50 sq. ft. 35 lbs.	1,657	1,817	1,905	1,957	2,040	2,130	2,210	2,295	2,377	2,462	2,857	3,142

OPTIONS

-PF02	Premium Metal Base Finish	\$101
-SM02	Super Matte Sable Wood Finish	\$23
-NS04	Non-Skid Glides	\$26

 = Available on quick-ship program (O535 Metallic Silver, O299 Polished Aluminum and standard wood base finishes only).

All shipments for this series will be blanket-wrapped as standard. For customers located in Territory 1 who require cartoning, a 5% upcharge will be added to each product. Please contact client services for additional information.

HOOM LOUNGE | Designed by Gower + Woolf

UPHOLSTERY COMBINATIONS:

- For upholstery combinations, refer to the pricing below.
- When combining two COM/COV/COL fabrics, or fabrics with the same grade, add \$120 List per unit.
- When combining three or more COM/COV/COL fabrics, or fabrics with the same grade, add \$150 List per unit.
- When combining different grades of fabric, price will be based on the highest grade specified.
- Two-tone upholstery examples and yardage requirements for the most common combinations are listed below. Additional combinations available; please contact client services for yardage requirements and pricing.
- Note: Yardage amounts are based on fabric which is plain (i.e. non-directional) and a full 54" wide.
- Appropriate upholstery code must be included.



Code	HM2
<u>Model</u>	<u>COM Requirement</u>
All	Seat Cushion = .75 yd. Balance of Chair = 2 yds.



Code	HM3
<u>Model</u>	<u>COM Requirement</u>
All	Inside Back and Seat Cushion = 1.25 yds. Balance of Chair = 1.75 yds.

All shipments for this series will be blanket-wrapped as standard. For customers located in Territory 1 who require cartoning, a 5% upcharge will be added to each product. Please contact client services for additional information.

HOOM STOOLS | Designed by Gower + Woolf



SPECIFICATIONS:

- Bar and counter-height models.
- Two base options available: 4-leg wood and wire rod metal.
- 4-leg wood base models feature chrome stretcher bar (not available in other finishes).
- Wire rod metal base available in standard and premium finishes. See below for options.
- For custom metal finish colors, please contact client services for pricing.
- 4-leg wood base offered in all standard finishes on Ash.
- For custom wood finishes, please add \$531 List per color per order.
- For Super Matte Sable Ash finish, upcharge applies. Refer to option section for pricing.
- 30" bar-height stool features footrest with 12.5" clearance from the floor.
- 25" counter-height stool features footrest with 7.5" clearance from the floor.
- 300 lb. weight capacity.
- Optional glides for hard surface flooring.
- All dimensions are nominal.
- Refer to terms and conditions for general information regarding fabrics, finishes, warranty, freight, complete condition of sales and more.

STANDARD METAL BASE FINISH COLORS:

- 0405 Charcoal Grey
- 0535 Metallic Silver
- 0199 Chrome
- 0630 Satin Black

PREMIUM METAL BASE FINISH COLORS:









- 0605 Matte Black
- 0705 Matte Cotton
- 0788 Glossy Cotton
- 0805 Oasis
- 0905 Mint
- 1005 Mercury
- 1105 Canary
- 1205 Stone
- 1305 Sage
- 1405 Ice Blue
- 1505 Clay

All shipments for this series will be blanket-wrapped as standard. For customers located in Territory 1 who require cartoning, a 5% upcharge will be added to each product. Please contact client services for additional information.

HOOM STOOLS | Designed by Gower + Woolf

ORDERING REQUIREMENTS:

- Model number
- Base finish
- Upholstery selection
- Options, as applicable

MODEL	PRODUCT SPECIFICATIONS	FABRIC GRADES								LEATHER			
		COM	A	1	2	3	4	COL 5	6	7	8	L1	L2
7012-25 	 Counter-Height Stool, Wire Rod Metal Base 21.25" W x 23" D x 38" H Seat: 17" W x 15.5" D Seat Ht: 25" COM: 1.25 yd. COL: 25 sq. ft. 23 lbs.	1,310	1,390	1,434	1,460	1,502	1,547	1,587	1,629	1,670	1,713	1,910	2,053
7012-30 	 Bar-Height Stool, Wire Rod Metal Base 21.25" W x 23" D x 41" H Seat: 17" W x 15.5" D Seat Ht: 30" COM: 1.25 yd. COL: 25 sq. ft. 25 lbs.	1,325	1,405	1,449	1,475	1,517	1,562	1,602	1,644	1,685	1,728	1,925	2,068
7014-25 	 Counter-Height Stool, 4-Leg Wood Base 21.25" W x 23" D x 38" H Seat: 17" W x 15.5" D Seat Ht: 25" COM: 1.25 yd. COL: 25 sq. ft. 21 lbs.	1,655	1,735	1,779	1,805	1,847	1,892	1,932	1,974	2,015	2,058	2,255	2,398
7014-30 	 Bar-Height Stool, 4-Leg Wood Base 21.25" W x 23" D x 41" H Seat: 17" W x 15.5" D Seat Ht: 30" COM: 1.25 yd. COL: 25 sq. ft. 23 lbs.	1,625	1,705	1,749	1,775	1,817	1,862	1,902	1,944	1,985	2,028	2,225	2,368

OPTIONS

-PF02	Premium Metal Base Finish	\$101
-SM02	Super Matte Sable Wood Finish	\$23
-CG02	Clear Glides (wire rod base models only)	\$12
-FG04	Felt Glides	\$26

 = Available on quick-ship program (0535 Metallic Silver, 0199 Chrome and standard wood base finishes only).

All shipments for this series will be blanket-wrapped as standard. For customers located in Territory 1 who require cartoning, a 5% upcharge will be added to each product. Please contact client services for additional information.

HOOM STOOLS | Designed by Gower + Woolf

UPHOLSTERY COMBINATIONS:

- For upholstery combinations, refer to the pricing below.
- When combining two COM/COV/COL fabrics, or fabrics with the same grade, add \$120 List per unit.
- When combining three or more COM/COV/COL fabrics, or fabrics with the same grade, add \$150 List per unit.
- When combining different grades of fabric, price will be based on the highest grade specified.
- Two-tone upholstery examples and yardage requirements for the most common combinations are listed below. Additional combinations available; please contact client services for yardage requirements and pricing.
- Note: Yardage amounts are based on fabric which is plain (i.e. non-directional) and a full 54" wide.
- Appropriate upholstery code must be included.



Code	HM4
<u>Model</u>	<u>COM Requirement</u>
All	Seat Cushion = .5 yd. Balance of Upholstery = 1 yd.

KENZIE OCCASIONAL TABLES | Designed by David Dahl



SPECIFICATIONS:

- Four table surface options: wood veneer, laminate, solid surface, or back-painted glass.
- Edge offered in wood veneer and laminate only.
- Two wood species available: Maple and Walnut.
- For custom wood finishes, please contact client services and add one-time upcharge of \$531 List per color per order.
- For Super Matte Sable Maple finish, upcharge applies. Refer to option section for pricing.
- For custom laminate finishes, add \$649 List per order per color. Pre-approval required, please contact client services.
- Glass tops are back-painted white as standard.
- Solid surface available in white only.
- Metal legs offered in standard and premium finishes. Please refer to listing below.
- For custom metal finish colors, please contact client services for pricing.
- All dimensions are nominal.
- Refer to terms and conditions for general information regarding finishes, warranty, freight, complete condition of sales and more.

STANDARD METAL LEG FINISH COLORS:

- 0405 Charcoal Grey
- 0535 Metallic Silver
- 0199 Chrome
- 0630 Satin Black

PREMIUM METAL LEG FINISH COLORS:



- 0605 Matte Black
- 0705 Matte Cotton
- 0788 Glossy Cotton
- 0805 Oasis
- 0905 Mint
- 1005 Mercury
- 1105 Canary
- 1205 Stone
- 1305 Sage
- 1405 Ice Blue
- 1505 Clay

All shipments for this series will be blanket-wrapped as standard. For customers located in Territory 1 who require cartoning, a 5% upcharge will be added to each product. Please contact client services for additional information.

KENZIE OCCASIONAL TABLES | Designed by David Dahl

ORDERING REQUIREMENTS:

- Model number
- Top surface
- Top finish, as applicable
- Edge surface
- Edge finish
- Leg finish
- Options, as applicable

	MODEL	VENEER (-V) OR LAMINATE (-L) TOP	SOLID SURFACE (-SF) TOP	BACK-PAINTED GLASS TOP (-GL)	WEIGHT
	16" Height Table				
	700-1916-()	1,364	1,556	1,478	15 lbs.
	700-2116-()	1,503	1,738	1,647	16 lbs.
	700-2916-()	1,919	2,398	2,113	22 lbs.
	700-3616-()	2,373	3,306	2,712	29 lbs.
	18" Height Table				
	700-1918-()	1,381	1,573	1,498	16 lbs.
	700-2118-()	1,524	1,759	1,667	17 lbs.
	700-2918-()	1,938	2,417	2,132	23 lbs.
	700-3618-()	2,393	3,326	2,729	30 lbs.
	20" Height Table				
	700-1920-()	1,403	1,595	1,518	17 lbs.
	700-2120-()	1,542	1,777	1,686	18 lbs.
	700-2920-()	1,960	2,439	2,155	24 lbs.
	700-3620-()	2,412	3,345	2,751	31 lbs.

OPTIONS

-PF02	Premium Metal Leg Finish	\$101
-SMO4	Super Matte Sable Wood Finish	\$46

All shipments for this series will be blanket-wrapped as standard. For customers located in Territory 1 who require cartoning, a 5% upcharge will be added to each product. Please contact client services for additional information.

KITSY | Designed by Just Meijer



SPECIFICATIONS:

- Polypropylene shell and fully upholstered models.
- Polypropylene shells consists of 30% recycled material.
- Five base options available: 4-leg, A-frame, swivel with glides, swivel with casters and wood legs.
- Swivel base models with glides feature self-return.
- 4-leg model offered with arms or armless.
- Arm finish will match leg finish unless specified otherwise.
- Wood legs feature black metal trim as standard. For alternate metal trim finishes, please specify "-LT01" after model number and add \$119 List per unit. Please note that 0199 Chrome and 0299 Polished Aluminum are not available on trim.
- Wood legs available in all standard and custom finishes on beech.
- For custom wood finishes, please contact client services and add one-time upcharge of \$531 List per color per order.
- For Super Matte Sable Beech finish, upcharge applies. Refer to option section for pricing.
- 4-leg models stack up to 5 high standing or 10 with dolly, with or without arms, and feature 3/4" tube diameter.
- A-frame models stack up to 7 high standing or 8 with dolly.
- If cartoning is required for 4-leg or A-frame models, chairs are packaged in units of three (3). A \$20 List carton break charge will be applied for orders with only one or two chairs.
- Swivel base model with casters features non-tilt, height adjustable mechanism.
- 300 lb. weight capacity
- All dimensions are nominal.
- Refer to terms and conditions for general information regarding finishes, warranty, freight, complete condition of sales and more.

STANDARD METAL BASE FINISH COLORS:

- 0405 Charcoal Grey
- 0535 Metallic Silver
- 0199 Chrome (4-leg and A-frame bases only)
- 0299 Polished Aluminum (swivel bases only)
- 0630 Satin Black

PREMIUM METAL BASE FINISH COLORS:

- 0605 Matte Black
- 0705 Matte Cotton
- 0788 Glossy Cotton
- 0805 Oasis
- 0905 Mint
- 1005 Mercury
- 1105 Canary
- 1205 Stone
- 1305 Sage
- 1405 Ice Blue
- 1505 Clay

POLYPROPYLENE COLORS:









- 140 Oasis
- 141 Mint
- 142 Mercury
- 143 Canary
- 148 Raven
- 149 Stark
- 150 Stone

All shipments for this series will be blanket-wrapped as standard. For customers located in Territory 1 who require cartoning, a 5% upcharge will be added to each product. Please contact client services for additional information.

KITSY | Designed by Just Meijer

ORDERING REQUIREMENTS:

- Model number
- Poly color
- Base/leg finish
- Wood leg metal trim finish, as applicable
- Options, as applicable

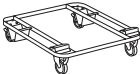
MODEL	PRODUCT SPECIFICATIONS	LIST
6811 	 Polypropylene Shell, 4-Leg Base, Armless 21" W x 21.5" D x 31.75" H Seat: 18.5" W x 16" D Seat Ht: 17.75" 13 lbs.	557
6812 	 Polypropylene Shell, 4-Leg Base, Arms 21" W x 21.5" D x 31.75" H Seat: 18.5" W x 16" D Seat Ht: 17.75" Arm Ht: 26.25" 17 lbs.	604
6813 	 Polypropylene Shell, A-Frame Base, Armless 20.5" W x 22.25" D x 31.25" H Seat: 18.5" W x 16" D Seat Ht: 17.25" 15 lbs.	675
6814 	 Polypropylene Shell, Wood Legs, Armless 19.5" W x 22" D x 31.75" H Seat: 18.5" W x 16" D Seat Ht: 17.75" 14 lbs.	878
6800 	Dolly (Black Finish Only) 24" W x 30" D x 6" H 37 lbs.	625

OPTIONS

-PF02	Premium Metal Base/Leg Finish	\$101
-SM02	Super Matte Sable Wood Finish	\$23
-NS04	Non-Skid Glides	\$26
-LT01	Alternate Wood Leg Metal Trim Finish	\$119





 = Available on quick-ship program (0535 Metallic Silver, 0199 Chrome and standard wood base finishes only).

All shipments for this series will be blanket-wrapped as standard. For customers located in Territory 1 who require cartoning, a 5% upcharge will be added to each product. Please contact client services for additional information.

KITSY | Designed by Just Meijer

ORDERING REQUIREMENTS:

- Model number
- Poly color
- Base finish
- Options, as applicable

MODEL	PRODUCT SPECIFICATIONS	LIST
6815 	 Polypropylene Shell, Non-Tilt Swivel Base, Glides 20.5" W x 22.25" D x 31.25" H Seat: 18.5" W x 16" D Seat Ht: 17.75" 18 lbs.	925
6816 	 Polypropylene Shell, Non-Tilt Swivel Base, Casters 20.5" W x 22.25" D x 31.25" - 34.25" H Seat: 18.5" W x 16" D Seat Ht: 17.75" - 20.75" 18 lbs.	925

OPTIONS

-PF02	Premium Metal Base Finish	\$101
-STC02	Soft Tread Casters	\$33
-STLC02	Soft Tread Self-Locking Casters	\$63









 = Available on quick-ship program (0535 Metallic Silver, 0299 Polished Aluminum base finishes only).

All shipments for this series will be blanket-wrapped as standard. For customers located in Territory 1 who require cartoning, a 5% upcharge will be added to each product. Please contact client services for additional information.

KITSY | Designed by Just Meijer

ORDERING REQUIREMENTS:

- Model number
- Base/leg finish
- Wood leg metal trim finish, as applicable
- Upholstery selection
- Options, as applicable

MODEL	PRODUCT SPECIFICATIONS	FABRIC GRADES								LEATHER			
		COM	A	1	2	3	4	COL 5	6	7	8	L1	L2
6811-U 	 Fully Upholstered, 4-Leg Base, Armless 21" W x 21.5" D x 31.75" H Seat: 18.5" W x 16" D Seat Ht: 18.25" COM: 1.25 yds. COL: 25 sq. ft. 13 lbs.	853	933	977	1,003	1,045	1,090	1,130	1,172	1,213	1,256	1,453	1,596
6812-U 	 Fully Upholstered, 4-Leg Base, Arms 21" W x 21.5" D x 31.75" H Seat: 18.5" W x 16" D Seat Ht: 18.25" Arm Ht: 26.25" COM: 1.25 yds. COL: 25 sq. ft. 17 lbs.	900	980	1,024	1,050	1,092	1,137	1,177	1,219	1,260	1,303	1,500	1,643
6813-U 	 Fully Upholstered, A-Frame Base, Armless 20.5" W x 22.25" D x 31.25" H Seat: 18.5" W x 16" D Seat Ht: 17.75" COM: 1.25 yds. COL: 25 sq. ft. 15 lbs.	971	1,051	1,095	1,121	1,163	1,208	1,248	1,290	1,331	1,374	1,571	1,714
6814-U 	 Fully Upholstered, Wood Legs, Armless 19.5" W x 22" D x 31.75" H Seat: 18.5" W x 16" D Seat Ht: 18.25" COM: 1.25 yds. COL: 25 sq. ft. 14 lbs.	1,174	1,254	1,298	1,324	1,366	1,411	1,451	1,493	1,534	1,577	1,774	1,917

OPTIONS

-PF02	Premium Metal Base/Leg Finish	\$101
-NS04	Non-Skid Glides	\$26
-LT01	Alternate Wood Leg Metal Trim Finish	\$119





 = Available on quick-ship program (0535 Metallic Silver, 0199 Chrome and standard wood base finishes only).

All shipments for this series will be blanket-wrapped as standard. For customers located in Territory 1 who require cartoning, a 5% upcharge will be added to each product. Please contact client services for additional information.

KITSY | Designed by Just Meijer

ORDERING REQUIREMENTS:

- Model number
- Base finish
- Upholstery selection
- Options, as applicable

MODEL	PRODUCT SPECIFICATIONS	FABRIC GRADES								LEATHER			
		COM	A	1	2	3	4	COL 5	6	7	8	L1	L2
6815-U 	 Fully Upholstered, Non-Tilt Swivel Base, Glides 20.5" W x 22.25" D x 31.25" H Seat: 18.5" W x 16" D Seat Ht: 17.75" COM: 1.25 yds. COL: 25 sq. ft. 18 lbs.	1,221	1,301	1,345	1,371	1,413	1,458	1,498	1,540	1,581	1,624	1,821	1,964
6816-U 	 Fully Upholstered, Non-Tilt Swivel Base, Casters 20.5" W x 22.25" D x 31.25" - 34.25" H Seat: 18.5" W x 16" D Seat Ht: 17.75" - 20.75" COM: 1.25 yds. COL: 25 sq. ft. 18 lbs.	1,221	1,301	1,345	1,371	1,413	1,458	1,498	1,540	1,581	1,624	1,821	1,964

OPTIONS

-PF02	Premium Metal Base Finish	\$101
-STC02	Soft Tread Casters	\$33
-STLC02	Soft Tread Self-Locking Casters	\$63

 = Available on quick-ship program (0535 Metallic Silver, 0299 Polished Aluminum base finishes only).

All shipments for this series will be blanket-wrapped as standard. For customers located in Territory 1 who require cartoning, a 5% upcharge will be added to each product. Please contact client services for additional information.

KUVI WORK LOUNGE | Designed by Chris & Jon Panichella



SPECIFICATIONS:

- Arm and armless models available with glides or casters.
- Arm caps available in Ash wood and black urethane.
- Wood arm caps available in all standard finishes on Ash.
- For Super Matte Sable Ash finish, upcharge applies. Refer to option section for pricing.
- For custom wood finishes, please add \$531 List per color per order.
- Frame also functions as a handle for mobility ease.
- Mobile lounge chairs feature two locking casters in rear and two non-locking casters in front.
- Casters feature semi-soft treads for compatibility on all floor surfaces.
- Tubular steel frame.
- 350 lb. weight capacity.
- All dimensions are nominal.
- Refer to terms and conditions for general information regarding fabrics, finishes, warranty, freight, complete condition of sales and more.

ROTATING TABLET:

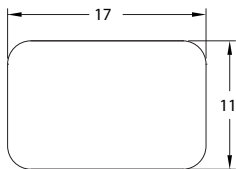

- Affixed to right or left arm, as specified.
- Tablet size is 17" W x 11" D x .75" thick and features 360-degree turning radius.
- Available in Ash and laminate surface options.
- For Super Matte Sable Ash finish, upcharge applies. Refer to option section for pricing.
- For custom wood finishes, please contact client services and add one-time upcharge of \$531 List per color per order.
- For custom laminate options, add \$649 List per color per order. Pre-approval required, please contact client services.
- For standard wood grain laminate or solid black laminate tops, edge will match unless specified otherwise.
- For all other solid laminates, edge will be exposed plywood substrate with clear coat finish.
- 100 lb. weight capacity.

KUVI WORK LOUNGE | Designed by Chris & Jon Panichella

UNDER-SEAT SHELF:

- Available on caster models only.
- Dimensions: 24" W x 21" D.
- Surface finish options include ash veneer as well as laminate selections.
- For Super Matte Sable Ash finish, upcharge applies. Refer to option section for pricing.
- Under-seat shelf features .5" tall guard rail.
- Guardrail will match frame finish unless otherwise specified.

SIDE TABLE:

- Measures 14" W x 8" D x .75" thick.
- Available in Ash and laminate surface options.
- For Super Matte Sable Ash finish, upcharge applies. Refer to option section for pricing.
- Optional cup holder available, with Clear Anodized Aluminum finish as standard.
- Black cup holder also offered at no upcharge. Please specify.
- Cupholder dimensions: 4" outer diameter, 3.25" inner diameter (cup size) x 3" deep.

STANDARD METAL FRAME FINISH COLORS:

- 0405 Charcoal Grey
- 0535 Metallic Silver
- 0630 Satin Black

PREMIUM METAL FRAME FINISH COLORS:





- 0605 Matte Black
- 0705 Matte Cotton
- 0788 Glossy Cotton
- 0805 Oasis
- 0905 Mint
- 1005 Mercury
- 1105 Canary
- 1205 Stone
- 1305 Sage
- 1405 Ice Blue
- 1505 Clay

All shipments for this series will be blanket-wrapped as standard. For customers located in Territory 1 who require cartoning, a 5% upcharge will be added to each product. Please contact client services for additional information.

KUVI WORK LOUNGE | Designed by Chris & Jon Panichella

ORDERING REQUIREMENTS:

- Model number
- Arm cap finish, as applicable
- Tablet and/or side table finish, as applicable
- Frame finish
- Upholstery selection
- Options, as applicable

MODEL	PRODUCT SPECIFICATIONS	FABRIC GRADES								LEATHER			
		COM	A	1	2	3	4	COL 5	6	7	8	L1	L2
1210-NA-NA 	Lounge Chair, Armless, Glides 25" W x 29.25" D x 31.5" H Seat: 22.5" W x 19" D Seat Ht: 17" COM: 2.25 yds. COL: 45 sq. ft. 25 lbs.	1,861	2,005	2,084	2,131	2,206	2,287	2,359	2,435	2,509	2,586	2,941	3,198
1210-AW-AW 1210-AU-AU 	Lounge Chair, Arms, Glides 26.5" W x 29.25" D x 31.5" H Seat: 22.5" W x 19" D Seat Ht: 17" COM: 2.25 yds. COL: 45 sq. ft. 29 lbs.	Arm Cap Wood (-AW) 2,209	2,353	2,432	2,479	2,554	2,635	2,707	2,783	2,857	2,934	3,289	3,546
		Arm Cap Urethane (-AU) 2,077	2,221	2,300	2,347	2,422	2,503	2,575	2,651	2,725	2,802	3,157	3,414
1210-TL-AW 1210-TL-AU 	Lounge Chair, Tablet Left, Arm Right, Glides 29" W x 29.25" D x 31.5" H Seat: 22.5" W x 19" D Seat Ht: 17" COM: 2.25 yds. COL: 45 sq. ft. 32 lbs.	Arm Cap Wood (-AW) 2,301	2,445	2,524	2,571	2,646	2,727	2,799	2,875	2,949	3,026	3,381	3,638
		Arm Cap Urethane (-AU) 2,235	2,379	2,458	2,505	2,580	2,661	2,733	2,809	2,883	2,960	3,315	3,572
1210-AW-TR 1210-AU-TR 	Lounge Chair, Arm Left, Tablet Right, Glides 29" W x 29.25" D x 31.5" H Seat: 22.5" W x 19" D Seat Ht: 17" COM: 2.25 yds. COL: 45 sq. ft. 32 lbs.	Arm Cap Wood (-AW) 2,301	2,445	2,524	2,571	2,646	2,727	2,799	2,875	2,949	3,026	3,381	3,638
		Arm Cap Urethane (-AU) 2,235	2,379	2,458	2,505	2,580	2,661	2,733	2,809	2,883	2,960	3,315	3,572

OPTIONS





-PF02	Premium Metal Finish	\$101
-SM01	Super Matte Sable Wood Finish (per arm/tablet/side table)	\$12
-CL	Clean-Out Feature	\$87

All shipments for this series will be blanket-wrapped as standard. For customers located in Territory 1 who require cartoning, a 5% upcharge will be added to each product. Please contact client services for additional information.

KUVI WORK LOUNGE | Designed by Chris & Jon Panichella

ORDERING REQUIREMENTS:

- Model number
- Arm cap finish, as applicable
- Tablet and/or side table finish, as applicable
- Frame finish
- Upholstery selection
- Options, as applicable

MODEL	PRODUCT SPECIFICATIONS	FABRIC GRADES								LEATHER				
		COM	A	1	2	3	4	COL 5	6	7	8	L1	L2	
1210-SL-TR 	Lounge Chair, Side Table Left, Tablet Right, Glides 34.75" W x 29.25" D x 31.5" H Seat: 22.5" W x 19" D Seat Ht: 17" COM: 2.25 yds. COL: 45 sq. ft. 33 lbs.	2,306	2,450	2,529	2,576	2,651	2,732	2,804	2,880	2,954	3,031	3,386	3,643	
1210-TL-SR 	Lounge Chair, Tablet Left, Side Table Right, Glides 34.75" W x 29.25" D x 31.5" H Seat: 22.5" W x 19" D Seat Ht: 17" COM: 2.25 yds. COL: 45 sq. ft. 33 lbs.	2,306	2,450	2,529	2,576	2,651	2,732	2,804	2,880	2,954	3,031	3,386	3,643	
1210-SL-AW 1210-SL-AU 	Lounge Chair, Side Table Left, Arm Right, Glides 32.25" W x 29.25" D x 31.5" H Seat: 22.5" W x 19" D Seat Ht: 17" COM: 2.25 yds. COL: 45 sq. ft. 30 lbs.	Arm Cap Wood (-AW)	2,214	2,358	2,437	2,484	2,559	2,640	2,712	2,788	2,862	2,939	3,294	3,551
		Arm Cap Urethane (-AU)	2,148	2,292	2,371	2,418	2,493	2,574	2,646	2,722	2,796	2,873	3,228	3,485
1210-AW-SR 1210-AU-SR 	Lounge Chair, Arm Left, Side Table Right, Glides 32.25" W x 29.25" D x 31.5" H Seat: 22.5" W x 19" D Seat Ht: 17" COM: 2.25 yds. COL: 45 sq. ft. 30 lbs.	Arm Cap Wood (-AW)	2,214	2,358	2,437	2,484	2,559	2,640	2,712	2,788	2,862	2,939	3,294	3,551
		Arm Cap Urethane (-AU)	2,148	2,292	2,371	2,418	2,493	2,574	2,646	2,722	2,796	2,873	3,228	3,485

OPTIONS





-PF02	Premium Metal Finish	\$101
-SM01	Super Matte Sable Wood Finish (per arm/tablet/side table)	\$12
-CH01	Cup Holder	\$142
-CL	Clean-Out Feature	\$87

All shipments for this series will be blanket-wrapped as standard. For customers located in Territory 1 who require cartoning, a 5% upcharge will be added to each product. Please contact client services for additional information.

KUVI WORK LOUNGE | Designed by Chris & Jon Panichella

ORDERING REQUIREMENTS:

- Model number
- Arm cap finish, as applicable
- Tablet and/or side table finish, as applicable
- Frame finish
- Upholstery selection
- Options, as applicable

MODEL	PRODUCT SPECIFICATIONS	FABRIC GRADES								LEATHER		
		COM	A	1	2	3	4	COL 5	6	7	8	L1
 <p>1210-TL-NA Lounge Chair, Tablet Left, Glides 28.25" W x 29.25" D x X31.5" H Seat: 22.5" W x 19" D Seat Ht: 17" COM: 2.25 yds. COL: 45 sq. ft. 29 lbs.</p>	2,127	2,271	2,350	2,397	2,472	2,553	2,625	2,701	2,775	2,852	3,207	3,464
 <p>1210-NA-TR Lounge Chair, Tablet Right, Glides 28.25" W x 29.25" D x X31.5" H Seat: 22.5" W x 19" D Seat Ht: 17" COM: 2.25 yds. COL: 45 sq. ft. 29 lbs.</p>	2,127	2,271	2,350	2,397	2,472	2,553	2,625	2,701	2,775	2,852	3,207	3,464
 <p>1210-SL-NA Lounge Chair, Side Table Left, Glides 31.5" W x 29.25" D x X31.5" H Seat: 22.5" W x 19" D Seat Ht: 17" COM: 2.25 yds. COL: 45 sq. ft. 27 lbs.</p>	2,040	2,184	2,263	2,310	2,385	2,466	2,538	2,614	2,688	2,765	3,120	3,377
 <p>1210-NA-SR Lounge Chair, Side Table Right, Glides 31.5" W x 29.25" D x X31.5" H Seat: 22.5" W x 19" D Seat Ht: 17" COM: 2.25 yds. COL: 45 sq. ft. 27 lbs.</p>	2,040	2,184	2,263	2,310	2,385	2,466	2,538	2,614	2,688	2,765	3,120	3,377

OPTIONS





-PF02	Premium Metal Finish	\$101
-SM01	Super Matte Sable Wood Finish (tablet/side table)	\$12
-CH01	Cup Holder (side table models only)	\$142
-CL	Clean-Out Feature	\$87

All shipments for this series will be blanket-wrapped as standard. For customers located in Territory 1 who require cartoning, a 5% upcharge will be added to each product. Please contact client services for additional information.

KUVI WORK LOUNGE | Designed by Chris & Jon Panichella

ORDERING REQUIREMENTS:

- Model number
- Arm cap finish, as applicable
- Tablet and/or side table finish, as applicable
- Frame finish
- Upholstery selection
- Options, as applicable

MODEL	PRODUCT SPECIFICATIONS	FABRIC GRADES								LEATHER			
		COM	A	1	2	3	4	COL 5	6	7	8	L1	L2
1250-NA-NA 	Lounge Chair, Armless, Casters 26" W x 29.25" D x 32.25" H Seat: 22.5" W x 19" D Seat Ht: 17.75" COM: 2.25 yds. COL: 45 sq. ft. 26 lbs.	1,938	2,082	2,161	2,208	2,283	2,364	2,436	2,512	2,586	2,663	3,018	3,275
1250-AW-AW 1250-AU-AU 	Lounge Chair, Arms, Casters 26.5" W x 29.25" D x 32.25" H Seat: 22.5" W x 19" D Seat Ht: 17.75" COM: 2.25 yds. COL: 45 sq. ft. 30 lbs.	Arm Cap Wood (-AW) 2,286	2,430	2,509	2,556	2,631	2,712	2,784	2,860	2,934	3,011	3,366	3,623
		Arm Cap Urethane (-AU) 2,154	2,298	2,377	2,424	2,499	2,580	2,652	2,728	2,802	2,879	3,234	3,491
1250-TL-AW 1250-TL-AU 	Lounge Chair, Tablet Left, Arm Right, Casters 29" W x 29.25" D x 32.25" H Seat: 22.5" W x 19" D Seat Ht: 17.75" COM: 2.25 yds. COL: 45 sq. ft. 33 lbs.	Arm Cap Wood (-AW) 2,378	2,522	2,601	2,648	2,723	2,804	2,876	2,952	3,026	3,103	3,458	3,715
		Arm Cap Urethane (-AU) 2,312	2,456	2,535	2,582	2,657	2,738	2,810	2,886	2,960	3,037	3,392	3,649
1250-AW-TR 1250-AU-TR 	Lounge Chair, Arm Left, Tablet Right, Casters 29" W x 29.25" D x 32.25" H Seat: 22.5" W x 19" D Seat Ht: 17.75" COM: 2.25 yds. COL: 45 sq. ft. 33 lbs.	Arm Cap Wood (-AW) 2,378	2,522	2,601	2,648	2,723	2,804	2,876	2,952	3,026	3,103	3,458	3,715
		Arm Cap Urethane (-AU) 2,312	2,456	2,535	2,582	2,657	2,738	2,810	2,886	2,960	3,037	3,392	3,649

OPTIONS





-PF02	Premium Metal Finish	\$101
-SM01	Super Matte Sable Wood Finish (per arm/tablet)	\$12
-USS01	Under-Seat Shelf	\$368
-USS01-SMO2	Under-Seat Shelf - Super Matte Sable Wood Finish	\$373
-CL	Clean-Out Feature	\$87

All shipments for this series will be blanket-wrapped as standard. For customers located in Territory 1 who require cartoning, a 5% upcharge will be added to each product. Please contact client services for additional information.

KUVI WORK LOUNGE | Designed by Chris & Jon Panichella

ORDERING REQUIREMENTS:

- Model number
- Arm cap finish, as applicable
- Tablet and/or side table finish, as applicable
- Frame finish
- Upholstery selection
- Options, as applicable

MODEL	PRODUCT SPECIFICATIONS	FABRIC GRADES								LEATHER		
		COM	A	1	2	3	4	COL 5	6	7	8	L1
 <p>1250-SL-TR Lounge Chair, Side Table Left, Tablet Right, Casters 34.75" W x 29.25" D x 32.25" H Seat: 22.5" W x 19" D Seat Ht: 18.5" COM: 2.25 yds. COL: 45 sq. ft. 34 lbs.</p>	2,383	2,527	2,606	2,653	2,728	2,809	2,881	2,957	3,031	3,108	3,463	3,720
 <p>1250-TL-SR Lounge Chair, Tablet Left, Side Table Right, Casters 34.75" W x 29.25" D x 32.25" H Seat: 22.5" W x 19" D Seat Ht: 18.5" COM: 2.25 yds. COL: 45 sq. ft. 34 lbs.</p>	2,383	2,527	2,606	2,653	2,728	2,809	2,881	2,957	3,031	3,108	3,463	3,720
 <p>1250-SL-AW 1250-SL-AU Lounge Chair, Side Table Left, Arm Right, Casters 32.25" W x 29.25" D x 32.25" H Seat: 22.5" W x 19" D Seat Ht: 17.75" COM: 2.25 yds. COL: 45 sq. ft. 31 lbs.</p>	Arm Cap Wood (-AW) 2,291	2,435	2,514	2,561	2,636	2,717	2,789	2,865	2,939	3,016	3,371	3,628
	Arm Cap Urethane (-AU) 2,225	2,369	2,448	2,495	2,570	2,651	2,723	2,799	2,873	2,950	3,305	3,562
 <p>1250-AW-SR 1250-AU-SR Lounge Chair, Arm Left, Side Table Right, Casters 32.25" W x 29.25" D x 32.25" H Seat: 22.5" W x 19" D Seat Ht: 17.75" COM: 2.25 yds. COL: 45 sq. ft. 31 lbs.</p>	Arm Cap Wood (-AW) 2,291	2,435	2,514	2,561	2,636	2,717	2,789	2,865	2,939	3,016	3,371	3,628
	Arm Cap Urethane (-AU) 2,225	2,369	2,448	2,495	2,570	2,651	2,723	2,799	2,873	2,950	3,305	3,562

OPTIONS





-PF02	Premium Metal Finish	\$101
-SM01	Super Matte Sable Wood Finish (per arm/tablet)	\$12
-CH01	Cup Holder	\$142
-USS01	Under-Seat Shelf	\$368
-USS01-SMO2	Under-Seat Shelf - Super Matte Sable Wood Finish	\$373
-CL	Clean-Out Feature	\$87

All shipments for this series will be blanket-wrapped as standard. For customers located in Territory 1 who require cartoning, a 5% upcharge will be added to each product. Please contact client services for additional information.

KUVI WORK LOUNGE | Designed by Chris & Jon Panichella

ORDERING REQUIREMENTS:

- Model number
- Arm cap finish, as applicable
- Tablet and/or side table finish, as applicable
- Frame finish
- Upholstery selection
- Options, as applicable

MODEL	PRODUCT SPECIFICATIONS	FABRIC GRADES								LEATHER		
		COM	A	1	2	3	4	COL 5	6	7	8	L1
 <p>1250-TL-NA Lounge Chair, Tablet Left, Casters 28.25" W x 29.25" D x 32.25" H Seat: 22.5" W x 19" D Seat Ht: 17.75" COM: 2.25 yds. COL: 45 sq. ft. 30 lbs.</p>	2,204	2,348	2,427	2,474	2,549	2,630	2,702	2,778	2,852	2,929	3,284	3,541
 <p>1250-NA-TR Lounge Chair, Tablet Right, Casters 28.25" W x 29.25" D x 32.25" H Seat: 22.5" W x 19" D Seat Ht: 17.75" COM: 2.25 yds. COL: 45 sq. ft. 30 lbs.</p>	2,204	2,348	2,427	2,474	2,549	2,630	2,702	2,778	2,852	2,929	3,284	3,541
 <p>1250-SL-NA Lounge Chair, Side Table Left, Casters 31.5" W x 29.25" D x 32.25" H Seat: 22.5" W x 19" D Seat Ht: 17.75" COM: 2.25 yds. COL: 45 sq. ft. 28 lbs.</p>	2,117	2,261	2,340	2,387	2,462	2,543	2,615	2,691	2,765	2,842	3,197	3,454
 <p>1250-NA-SR Lounge Chair, Side Table Right, Casters 31.5" W x 29.25" D x 32.25" H Seat: 22.5" W x 19" D Seat Ht: 17.75" COM: 2.25 yds. COL: 45 sq. ft. 28 lbs.</p>	2,117	2,261	2,340	2,387	2,462	2,543	2,615	2,691	2,765	2,842	3,197	3,454

OPTIONS

-PF02	Premium Metal Finish	\$101
-SM01	Super Matte Sable Wood Finish (side table)	\$12
-CH01	Cup Holder	\$142
-USS01	Under-Seat Shelf	\$368
-USS01-SMO2	Under-Seat Shelf - Super Matte Sable Wood Finish	\$373
-CL	Clean-Out Feature	\$87

All shipments for this series will be blanket-wrapped as standard. For customers located in Territory 1 who require cartoning, a 5% upcharge will be added to each product. Please contact client services for additional information.

KUVI WORK LOUNGE | Designed by Chris & Jon Panichella

UPHOLSTERY COMBINATIONS:

- For upholstery combinations, refer to the pricing below.
- When combining two COM/COV/COL fabrics, or fabrics with the same grade, add \$120 List per unit.
- When combining three or more COM/COV/COL fabrics, or fabrics with the same grade, add \$150 List per unit.
- When combining different grades of fabric, price will be based on the highest grade specified.
- Two-tone upholstery examples and yardage requirements for the most common combinations are listed below. Additional combinations available; please contact client services for yardage requirements and pricing.
- Note: Yardage amounts are based on fabric which is plain (i.e. non-directional) and a full 54" wide.
- Appropriate upholstery code must be included.



Code	KV1
<u>Model</u>	<u>COM Requirement</u>
All Models	Seat = 1 yd. Back = 1.25 yds.

All shipments for this series will be blanket-wrapped as standard. For customers located in Territory 1 who require cartoning, a 5% upcharge will be added to each product. Please contact client services for additional information.

LOUPE OCCASIONAL TABLES | Designed by Aaron Duke

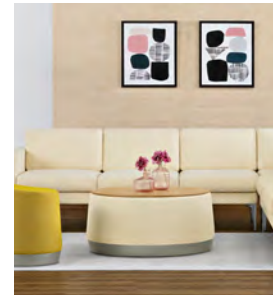

SPECIFICATIONS:

- Round occasional tables with upholstered sides available in 3 diameters: 22", 30" and 36".
- Three top surface options: wood veneer, laminate and solid surface.
- Tops are ½" thick.
- Wood veneer available in all standard and custom finishes on walnut and white oak.
- For Super Matte Sable White Oak finish, upcharge applies. Refer to option section for pricing.
- For standard wood grain laminate or solid black laminate tops, edge will match the top color unless specified otherwise.
- For all other solid laminates, edge will be exposed plywood substrate with clear coat finish.
- Solid wood base with painted finish.
- Base offered in standard and premium colors. Please refer to listing below.
- All dimensions are nominal.
- Refer to terms and conditions for general information regarding fabrics, finishes, warranty, freight, complete condition of sales and more.

STANDARD BASE FINISH COLORS:

- 0405 Charcoal Grey
- 0535 Metallic Silver
- 0630 Satin Black

PREMIUM BASE FINISH COLORS:

- 0605 Matte Black
- 0705 Matte Cotton
- 0788 Glossy Cotton
- 0805 Oasis
- 0905 Mint
- 1005 Mercury
- 1105 Canary
- 1205 Stone
- 1305 Sage
- 1405 Ice Blue
- 1505 Clay

All shipments for this series will be blanket-wrapped as standard. For customers located in Territory 1 who require cartoning, a 5% upcharge will be added to each product. Please contact client services for additional information.

LOUPE OCCASIONAL TABLES | Designed by Aaron Duke

ORDERING REQUIREMENTS:

- Model number
- Top surface
- Top finish
- Upholstery selection
- Base finish
- Options, as applicable

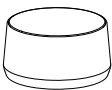
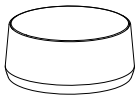
MODEL	PRODUCT SPECIFICATIONS	TOP FINISH	FABRIC GRADES								LEATHER			
			COM	A	1	2	3	4	COL 5	6	7	8	L1	L2
3620-2216-() 	22" Round Table 22" Dia. x 16.5" H Table-Top Diameter: 19.25" COM: 1.25 yds. COL: 25 sq. ft. 36 lbs.	Veneer (-V)	1,538	1,618	1,662	1,688	1,730	1,775	1,815	1,857	1,898	1,941	2,138	2,281
		Laminate (-L)	1,396	1,476	1,520	1,546	1,588	1,633	1,673	1,715	1,756	1,799	1,996	2,139
		Solid Surface (-SF)	1,654	1,734	1,778	1,804	1,846	1,891	1,931	1,973	2,014	2,057	2,254	2,397
3620-3016-() 	30" Round Table 30" Dia. x 16.5" H Table-Top Diameter: 27.25" COM: 1.25 yds. COL: 25 sq. ft. 46 lbs.	Veneer (-V)	2,168	2,248	2,292	2,318	2,360	2,405	2,445	2,487	2,528	2,571	2,768	2,911
		Laminate (-L)	1,911	1,991	2,035	2,061	2,103	2,148	2,188	2,230	2,271	2,314	2,511	2,654
		Solid Surface (-SF)	2,390	2,470	2,514	2,540	2,582	2,627	2,667	2,709	2,750	2,793	2,990	3,133
3620-3616-() 	36" Round Table 36" Dia. x 16.5" H Table-Top Diameter: 33.25" COM: 2 yds. COL: 40 sq. ft. 57 lbs.	Veneer (-V)	2,894	3,022	3,092	3,134	3,200	3,272	3,336	3,404	3,470	3,538	3,854	4,082
		Laminate (-L)	2,440	2,568	2,638	2,680	2,746	2,818	2,882	2,950	3,016	3,084	3,400	3,628
		Solid Surface (-SF)	3,373	3,501	3,571	3,613	3,679	3,751	3,815	3,883	3,949	4,017	4,333	4,561

OPTIONS

- PF02 Premium Base Finish \$101
- SM02 Super Matte Sable Wood Finish \$23

All shipments for this series will be cartoned as standard. If blanket-wrapped shipping is required, please contact client services for additional information.

LOUPE STOOLS | Designed by Aaron Duke

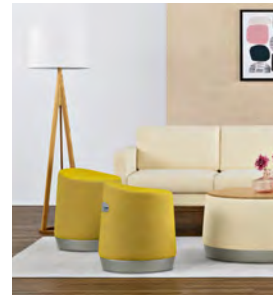

SPECIFICATIONS:

- 19" diameter stool available with directional or non-directional seat.
- Directional seat model comes standard with 360-degree swivel capability.
- Non-directional seat model offered with or without swivel capability.
- Grey reinforced nylon pull.
- Solid wood base with painted finish.
- All models come standard with nylon glides.
- 400 lb. weight capacity.
- All dimensions are nominal.
- Refer to terms and conditions for general information regarding fabrics, finishes, warranty, freight, complete condition of sales and more.

STANDARD BASE FINISH COLORS:

- 0405 Charcoal Grey
- 0535 Metallic Silver
- 0630 Satin Black

PREMIUM BASE FINISH COLORS:



- 0605 Matte Black
- 0705 Matte Cotton
- 0788 Glossy Cotton
- 0805 Oasis
- 0905 Mint
- 1005 Mercury
- 1105 Canary
- 1205 Stone
- 1305 Sage
- 1405 Ice Blue
- 1505 Clay

All shipments for this series will be cartoned as standard. If blanket-wrapped shipping is required, please contact client services for additional information.

LOUPE STOOLS | Designed by Aaron Duke

ORDERING REQUIREMENTS:

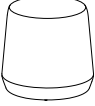
- Model number
- Upholstery selection
- Base finish
- Options, as applicable

MODEL	PRODUCT SPECIFICATIONS	FABRIC GRADES								LEATHER			
		COM	A	1	2	3	4	COL 5	6	7	8	L1	L2
3610 	19" Stool, Directional Seat, 360° Swivel 19" Dia. x 21" H Seat Diameter: 16" Seat Height: 18.75" COM: 1.25 yds. COL: 25 sq. ft. 31 lbs.	1,457	1,537	1,581	1,607	1,649	1,694	1,734	1,776	1,817	1,860	2,057	2,200
3615 	19" Stool, Non-Directional Seat 19" Dia. x 19" H Seat Diameter: 16" Seat Height: 18.5" COM: 1.25 yds. COL: 25 sq. ft. 26 lbs.	1,132	1,212	1,256	1,282	1,324	1,369	1,409	1,451	1,492	1,535	1,732	1,875
3615-S 	19" Stool, Non-Directional Seat, 360° Swivel 19" Dia. x 19" H Seat Diameter: 16" Seat Height: 18.5" COM: 1.25 yds. COL: 25 sq. ft. 31 lbs.	1,199	1,279	1,323	1,349	1,391	1,436	1,476	1,518	1,559	1,602	1,799	1,942

OPTIONS

-PF02 Premium Base Finish \$101

All shipments for this series will be cartoned as standard. If blanket-wrapped shipping is required, please contact client services for additional information.

LOUPE STOOLS | Designed by Aaron Duke

UPHOLSTERY COMBINATIONS:

- For upholstery combinations, refer to the pricing below.
- When combining two COM/COV/COL fabrics, or fabrics with the same grade, add \$120 List per unit.
- When combining different grades of fabric, price will be based on the highest grade specified.
- Two-tone upholstery examples and yardage requirements for the most common combinations are listed below. Additional combinations available; please contact client services for yardage requirements and pricing.
- Note: Yardage amounts are based on fabric which is plain (i.e. non-directional) and a full 54" wide.
- Appropriate upholstery code must be included.

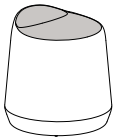

Code	LU1
<u>Model</u>	<u>COM Requirement</u>
3610	Top of Seat = .5 yd. Balance of Upholstery = 1 yd.

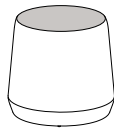

Code	LU2
<u>Model</u>	<u>COM Requirement</u>
3615	Top of Seat = .5 yd.
3616	Balance of Upholstery = 1 yd.

All shipments for this series will be blanket-wrapped as standard. For customers located in Territory 1 who require cartoning, a 5% upcharge will be added to each product. Please contact client services for additional information.

LUCENT® GUEST | Designed by Qdesign



SPECIFICATIONS:

- Passive-flex back.
- 3/4" steel frame.
- Three frame finish options. Please refer to listing below.
- 300 lb. weight capacity.
- All dimensions are nominal.
- Refer to terms and conditions for general information regarding fabrics, finishes, warranty, freight, complete condition of sales and more.

STANDARD METAL FRAME FINISH COLORS:

- 0405 Charcoal Grey
- 0535 Metallic Silver
- 0199 Chrome

All shipments for this series will be blanket-wrapped as standard. For customers located in Territory 1 who require cartoning, a 5% upcharge will be added to each product. Please contact client services for additional information.

LUCENT® GUEST | Designed by Qdesign

ORDERING REQUIREMENTS:

- Model number
- Frame finish
- Upholstery selection

MODEL	PRODUCT SPECIFICATIONS	FABRIC GRADES								LEATHER			
		COM	A	1	2	3	4	5	6	7	8	L1	L2
2910 	Guest Chair, Arms 24" W x 22.5" D x 33" H Seat: 18.5" W x 17.5" D Seat Ht: 18" Arm Ht: 25.5" COM: 1.25 yds. COL: 25 sq. ft. 20 lbs.	1,386	1,466	1,510	1,536	1,578	1,623	1,663	1,705	1,746	1,789	1,986	2,129

All shipments for this series will be blanket-wrapped as standard. For customers located in Territory 1 who require cartoning, a 5% upcharge will be added to each product. Please contact client services for additional information.

MAYLAND GUEST | Designed by Gower + Woolf



SPECIFICATIONS:

- Available with Beech wood or metal frame.
- Metal frame available in standard and premium finishes. See below for options.
- For custom metal finish colors, please contact client services for pricing.
- Wood frame offered in all standard and custom finishes on Beech.
- For Super Matte Sable Beech finish, upcharge applies. Refer to option section for pricing.
- For custom wood finishes, please contact client services and add one-time upcharge of \$531 List per color per order.
- 300 lb. weight capacity.
- All dimensions are nominal.
- Refer to terms and conditions for general information regarding fabrics, finishes, warranty, freight, complete condition of sales and more.

STANDARD METAL FRAME FINISH COLORS:

- 0405 Charcoal Grey
- 0535 Metallic Silver
- 0630 Satin Black

PREMIUM METAL FRAME FINISH COLORS:



- 0605 Matte Black
- 0705 Matte Cotton
- 0788 Glossy Cotton
- 0805 Oasis
- 0905 Mint
- 1005 Mercury
- 1105 Canary
- 1205 Stone
- 1305 Sage
- 1405 Ice Blue
- 1505 Clay

All shipments for this series will be blanket-wrapped as standard. For customers located in Territory 1 who require cartoning, a 5% upcharge will be added to each product. Please contact client services for additional information.

MAYLAND GUEST | Designed by Gower + Woolf

ORDERING REQUIREMENTS:

- Model number
- Frame finish
- Upholstery selection
- Options, as applicable

MODEL	PRODUCT SPECIFICATIONS	FABRIC GRADES								LEATHER			
		COM	A	1	2	3	4	COL 5	6	7	8	L1	L2
5920 	<p> Guest Chair, Metal Frame</p> <p>26" W x 27" D x 29.75" H Seat: 20" W x 18" D Seat Ht: 18" COM: 3 yds. COL: 60 sq. ft. 37 lbs.</p>	1,924	2,116	2,221	2,284	2,383	2,491	2,587	2,689	2,788	2,890	3,364	3,706
5920-W 	<p>Guest Chair, Wood Frame</p> <p>26.75" W x 27.5" D x 29.75" H Seat: 20" W x 18" D Seat Ht: 18" COM: 3 yds. COL: 60 sq. ft. 36 lbs.</p>	2,380	2,572	2,677	2,740	2,839	2,947	3,043	3,145	3,244	3,346	3,820	4,162

OPTIONS

-PF02	Premium Metal Frame Finish	\$101
-SM03	Super Matte Sable Wood Finish	\$34
-NS04	Non-Skid Glides	\$26
-VCT04	VCT Tile Glides	\$28

 = Available on quick-ship program (standard metal base finishes only).

MAYLAND GUEST | Designed by Gower + Woolf

UPHOLSTERY COMBINATIONS:

- For upholstery combinations, refer to the pricing below.
- When combining two COM/COV/COL fabrics, or fabrics with the same grade, add \$120 List per unit.
- When combining three or more COM/COV/COL fabrics, or fabrics with the same grade, add \$150 List per unit.
- When combining different grades of fabric, price will be based on the highest grade specified.
- Two-tone upholstery examples and yardage requirements for the most common combinations are listed below. Additional combinations available; please contact client services for yardage requirements and pricing.
- Note: Yardage amounts are based on fabric which is plain (i.e. non-directional) and a full 54" wide.
- Appropriate upholstery code must be included.



Code	MA1
<u>Model</u>	<u>COM Requirement</u>
All	Back Cushion Only = .75 yd. Balance of Chair = 2.75 yds.



Code	MA2
<u>Model</u>	<u>COM Requirement</u>
All	Seat Cushion Only = 1 yd. Balance of Chair = 2.75 yds.



Code	MA3
<u>Model</u>	<u>COM Requirement</u>
All	Seat & Back Cushion = 1.25 yds. Balance of Chair = 2.25 yds.

All shipments for this series will be blanket-wrapped as standard. For customers located in Territory 1 who require cartoning, a 5% upcharge will be added to each product. Please contact client services for additional information.

MAYLAND LOUNGE | Designed by Gower + Woolf



SPECIFICATIONS:

- Available with Beech wood or metal frame.
- Metal frame available in standard and premium finishes. See below for options.
- For custom metal finish colors, please contact client services for pricing.
- Wood frame offered in all standard and custom finishes on Beech.
- For Super Matte Sable Beech finish, upcharge applies. Refer to option section for pricing.
- For custom wood finishes, please contact client services and add one-time upcharge of \$531 List per color per order.
- 350 lb. weight capacity.
- All dimensions are nominal.
- Refer to terms and conditions for general information regarding fabrics, finishes, warranty, freight, complete condition of sales and more.

STANDARD METAL FRAME FINISH COLORS:

- 0405 Charcoal Grey
- 0535 Metallic Silver
- 0630 Satin Black

PREMIUM METAL FRAME FINISH COLORS:

- 0605 Matte Black
- 0705 Matte Cotton
- 0788 Glossy Cotton
- 0805 Oasis
- 0905 Mint
- 1005 Mercury
- 1105 Canary
- 1205 Stone
- 1305 Sage
- 1405 Ice Blue
- 1505 Clay

All shipments for this series will be blanket-wrapped as standard. For customers located in Territory 1 who require cartoning, a 5% upcharge will be added to each product. Please contact client services for additional information.

MAYLAND LOUNGE | Designed by Gower + Woolf

ORDERING REQUIREMENTS:

- Model number
- Frame finish
- Upholstery selection
- Options, as applicable

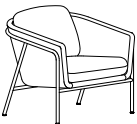
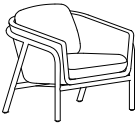
MODEL	PRODUCT SPECIFICATIONS	FABRIC GRADES								LEATHER			
		COM	A	1	2	3	4	COL 5	6	7	8	L1	L2
5901 	🕒 Lounge Chair, Metal Frame 30.5" W x 30" D x 29.75" H Seat: 24" W x 19.5" D Seat Ht: 16.75" COM: 4 yds. COL: 80 sq. ft. 52 lbs.	2,308	2,564	2,704	2,788	2,920	3,064	3,192	3,328	3,460	3,596	4,228	4,684
5901-W 	Lounge Chair, Wood Frame 31.75" W x 31" D x 29.75" H Seat: 24" W x 19.5" D Seat Ht: 16.75" COM: 4 yds. COL: 80 sq. ft. 51 lbs.	2,834	3,090	3,230	3,314	3,446	3,590	3,718	3,854	3,986	4,122	4,754	5,210

OPTIONS

-PF02	Premium Metal Frame Finish	\$101
-SM03	Super Matte Sable Wood Finish	\$34
-NS04	Non-Skid Glides	\$26
-VCT04	VCT Tile Glides	\$28

🕒 = Available on quick-ship program (standard metal base finishes only).

MAYLAND LOUNGE | Designed by Gower + Woolf

UPHOLSTERY COMBINATIONS:

- For upholstery combinations, refer to the pricing below.
- When combining two COM/COV/COL fabrics, or fabrics with the same grade, add \$120 List per unit.
- When combining three or more COM/COV/COL fabrics, or fabrics with the same grade, add \$150 List per unit.
- When combining different grades of fabric, price will be based on the highest grade specified.
- Two-tone upholstery examples and yardage requirements for the most common combinations are listed below. Additional combinations available; please contact client services for yardage requirements and pricing.
- Note: Yardage amounts are based on fabric which is plain (i.e. non-directional) and a full 54" wide.
- Appropriate upholstery code must be included.



Code MY1

Model COM Requirement

All Back Cushion Only = .75 yd.
Balance of Chair = 3.5 yds.

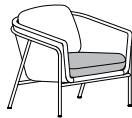

Code MY2

Model COM Requirement

All Seat Cushion Only = 1 yd.
Balance of Chair = 3.25 yds.

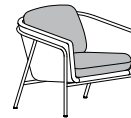

Code MY3

Model COM Requirement

All Seat & Back Cushion = 2 yds.
Balance of Chair = 2.5 yds.

All shipments for this series will be blanket-wrapped as standard. For customers located in Territory 1 who require cartoning, a 5% upcharge will be added to each product. Please contact client services for additional information.

MELINA CONFERENCE/EXECUTIVE | Licensed from Wiesner Hager - Austria



SPECIFICATIONS:

- Mid- and high back models.
- Aluminum die-cast base.
- Metal bases offered in standard and premium finishes. Please refer to listing below.
- For custom metal finish colors, please contact client services for pricing.
- 300 lb. weight capacity.
- All dimensions are nominal.
- Swivel-tilt with tilt lock mechanism.
- Refer to terms and conditions for general information regarding fabrics, finishes, warranty, freight, complete condition of sales and more.

STANDARD METAL BASE FINISH COLORS:

- 0405 Charcoal Grey
- 0535 Metallic Silver
- 0299 Polished Aluminum
- 0630 Satin Black

PREMIUM METAL BASE FINISH COLORS:

- 0605 Matte Black
- 0705 Matte Cotton
- 0788 Glossy Cotton
- 0805 Oasis
- 0905 Mint
- 1005 Mercury
- 1105 Canary
- 1205 Stone
- 1305 Sage
- 1405 Ice Blue
- 1505 Clay





All shipments for this series will be blanket-wrapped as standard. For customers located in Territory 1 who require cartoning, a 5% upcharge will be added to each product. Please contact client services for additional information.

MELINA CONFERENCE/EXECUTIVE | Licensed from Wiesner Hager - Austria

Swivel-Tilt with Tilt Lock Mechanism

ORDERING REQUIREMENTS:

- Model number
- Base finish
- Upholstery selection
- Options, as applicable

MODEL	PRODUCT SPECIFICATIONS	FABRIC GRADES								LEATHER			
		COM	A	1	2	3	4	COL 5	6	7	8	L1	L2
5254-M 	 Mid-Back Conference/Executive Chair 27.5" W x 27" D x 33" - 36" H Seat: 16" W x 18" D Seat Ht: 17" - 20" COM: 2 yds. COL: 40 sq. ft. 22 lbs.	1,728	1,856	1,926	1,968	2,034	2,106	2,170	2,238	2,304	2,372	2,688	2,916
5254-H 	 High Back Conference/Executive Chair 27.5" W x 29" D x 41" - 44" H Seat: 16" W x 18" D Seat Ht: 17" - 20" COM: 2.25 yds. COL: 45 sq. ft. 25 lbs.	1,784	1,928	2,007	2,054	2,129	2,210	2,282	2,358	2,432	2,509	2,864	3,121

OPTIONS

-PF02	Premium Metal Base Finish	\$101
-STC02	Soft Tread Casters	\$33
-STLC02	Soft Tread Self-Locking Casters	\$63
-GDO4	Glides	\$30
-J01	Jury Base (black only)	\$199

 = Available on quick-ship program (0299 Polished Aluminum base finish only).

MELINA CONFERENCE/EXECUTIVE | Licensed from Wiesner Hager - Austria

UPHOLSTERY COMBINATIONS:

- For upholstery combinations, refer to the pricing below.
- When combining two COM/COV/COL fabrics, or fabrics with the same grade, add \$120 List per unit.
- When combining three or more COM/COV/COL fabrics, or fabrics with the same grade, add \$150 List per unit.
- When combining different grades of fabric, price will be based on the highest grade specified.
- Two-tone upholstery examples and yardage requirements for the most common combinations are listed below. Additional combinations available; please contact client Services for yardage requirements and pricing.
- Note: Yardage amounts are based on fabric which is plain (i.e. non-directional) and a full 54" wide.
- Appropriate upholstery code must be included.



Code **ML1**
Model COM Requirement
5254-M Seat Cushion = 1 yd.
Balance of Chair = 1.5 yds.



Code **ML2**
Model COM Requirement
5254-H Seat Cushion = 1 yd.
Balance of Chair = 1.75 yds.



Code **ML3**
Model COM Requirement
5254-M Outside Back & Outside Arm Panel = 1 yd.
Balance of Chair = 1.5 yds.



Code **ML4**
Model COM Requirement
5254-H Outside Back & Outside Arm Panel = 1.25 yds.
Balance of Chair = 1.5 yds.

All shipments for this series will be blanket-wrapped as standard. For customers located in Territory 1 who require cartoning, a 5% upcharge will be added to each product. Please contact client services for additional information.

MELINA GUEST | Licensed from Wiesner Hager - Austria



SPECIFICATIONS:

- Four base options available: 4-leg metal, metal swivel, 4-leg wood and wood swivel.
- Swivel base models feature self-return.
- Metal bases offered in standard and premium finishes. Please refer to listing below.
- For custom metal finish colors, please contact client services for pricing.
- Wood bases offered in all standard and custom finishes on Ash.
- For custom wood finishes, please contact client services and add one-time upcharge of \$531 List per color per order.
- For Super Matte Sable Ash finish, upcharge applies. Refer to option section for pricing.
- 300 lb. weight capacity.
- All dimensions are nominal.
- Refer to terms and conditions for general information regarding fabrics, finishes, warranty, freight, complete condition of sales and more.

STANDARD METAL BASE FINISH COLORS:

- 0405 Charcoal Grey
- 0535 Metallic Silver
- 0199 Chrome (4-leg base only)
- 0299 Polished Aluminum (swivel base only)
- 0630 Satin Black

PREMIUM METAL BASE FINISH COLORS:







- 0605 Matte Black
- 0705 Matte Cotton
- 0788 Glossy Cotton
- 0805 Oasis
- 0905 Mint
- 1005 Mercury
- 1105 Canary
- 1205 Stone
- 1305 Sage
- 1405 Ice Blue
- 1505 Clay

All shipments for this series will be blanket-wrapped as standard. For customers located in Territory 1 who require cartoning, a 5% upcharge will be added to each product. Please contact client services for additional information.

MELINA GUEST | Licensed from Wiesner Hager - Austria

ORDERING REQUIREMENTS:

- Model number
- Base finish
- Upholstery selection
- Options, as applicable

MODEL	PRODUCT SPECIFICATIONS	FABRIC GRADES										LEATHER	
		COM	A	1	2	3	4	COL 5	6	7	8	L1	L2
52121 	 Guest Chair, 4-Leg Metal Base 27" W x 25.5" D x 33" H Seat: 16" W x 18" D Seat Ht: 18" COM: 2 yds. COL: 40 sq. ft. 22 lbs.	1,426	1,554	1,624	1,666	1,732	1,804	1,868	1,936	2,002	2,070	2,386	2,614
52123 	 Guest Chair, Metal Swivel Base 27.5" W x 27.5" D x 33" H Seat: 16" W x 18" D Seat Ht: 18" COM: 2 yds. COL: 40 sq. ft. 18 lbs.	1,630	1,758	1,828	1,870	1,936	2,008	2,072	2,140	2,206	2,274	2,590	2,818
52124 	 Guest Chair, 4-Leg Wood Base 27" W x 25.5" D x 33" H Seat: 16" W x 18" D Seat Ht: 18" COM: 2 yds. COL: 40 sq. ft. 17 lbs.	1,613	1,741	1,811	1,853	1,919	1,991	2,055	2,123	2,189	2,257	2,573	2,801
52127 	Guest Chair, Wood Swivel Base 29.5" W x 29.5" D x 33" H Seat: 16" W x 18" D Seat Ht: 18" COM: 2 yds. COL: 40 sq. ft. 19 lbs.	1,848	1,976	2,046	2,088	2,154	2,226	2,290	2,358	2,424	2,492	2,808	3,036

OPTIONS

-PF02	Premium Metal Base Finish	\$101
-SM02	Super Matte Sable Wood Finish	\$23
-NS04	Non-Skid Glides	\$26

 = Available on quick-ship program (0535 Metallic Silver, 0199 Chrome, 0299 Polished Aluminum and standard wood base finishes only).

MELINA GUEST | Licensed from Wiesner Hager - Austria

UPHOLSTERY COMBINATIONS:

- For upholstery combinations, refer to the pricing below.
- When combining two COM/COV/COL fabrics, or fabrics with the same grade, add \$120 List per unit.
- When combining three or more COM/COV/COL fabrics, or fabrics with the same grade, add \$150 List per unit.
- When combining different grades of fabric, price will be based on the highest grade specified.
- Two-tone upholstery examples and yardage requirements for the most common combinations are listed below. Additional combinations available; please contact client Services for yardage requirements and pricing.
- Note: Yardage amounts are based on fabric which is plain (i.e. non-directional) and a full 54" wide.
- Appropriate upholstery code must be included.



Code	ML1
<u>Model</u>	<u>COM Requirement</u>
All	Seat Cushion = 1 yd. Balance of Chair = 1.5 yds.



Code	ML2
<u>Model</u>	<u>COM Requirement</u>
All	Outside Back & Outside Arm Panel =1 yd. Balance of Chair = 1.5 yds.

All shipments for this series will be blanket-wrapped as standard. For customers located in Territory 1 who require cartoning, a 5% upcharge will be added to each product. Please contact client services for additional information.

MELINA LOUNGE | Licensed from Wiesner Hager - Austria



SPECIFICATIONS:

- Mid- and high back models.
- Three base options available: metal swivel, 4-leg wood and wood swivel.
- Swivel base models feature self-return.
- Metal swivel base offered in standard and premium finishes. Please refer to listing below.
- For custom metal finish colors, please contact client services for pricing.
- Wood bases offered in all standard and custom finishes on Ash.
- For custom wood finishes, please contact client services and add one-time upcharge of \$531 List per color per order.
- For Super Matte Sable Ash finish, upcharge applies. Refer to option section for pricing.
- 300 lb. weight capacity.
- All dimensions are nominal.
- Refer to terms and conditions for general information regarding fabrics, finishes, warranty, freight, complete condition of sales and more.

STANDARD METAL BASE FINISH COLORS:

- 0405 Charcoal Grey
- 0535 Metallic Silver
- 0299 Polished Aluminum
- 0630 Satin Black

PREMIUM METAL BASE FINISH COLORS:





- 0605 Matte Black
- 0705 Matte Cotton
- 0788 Glossy Cotton
- 0805 Oasis
- 0905 Mint
- 1005 Mercury
- 1105 Canary
- 1205 Stone
- 1305 Sage
- 1405 Ice Blue
- 1505 Clay

All shipments for this series will be blanket-wrapped as standard. For customers located in Territory 1 who require cartoning, a 5% upcharge will be added to each product. Please contact client services for additional information.

MELINA LOUNGE | Licensed from Wiesner Hager - Austria

ORDERING REQUIREMENTS:

- Model number
- Base finish
- Upholstery selection
- Options, as applicable

MODEL	PRODUCT SPECIFICATIONS	FABRIC GRADES								LEATHER			
		COM	A	1	2	3	4	COL 5	6	7	8	L1	L2
52223-M 	 Mid-Back Lounge Chair, Metal Swivel Base 28.5" W x 25.5" D x 31.5" H Seat: 18" W x 18" D Seat Ht: 16.75" COM: 2 yds. COL: 40 sq. ft. 25 lbs.	1,777	1,905	1,975	2,017	2,083	2,155	2,219	2,287	2,353	2,421	2,737	2,965
52224-M 	Mid-Back Lounge Chair, 4-Leg Wood Base 31.5" W x 31.5" D x 31.5" H Seat: 18" W x 18" D Seat Ht: 16.75" COM: 2 yds. COL: 40 sq. ft. 26 lbs.	1,643	1,771	1,841	1,883	1,949	2,021	2,085	2,153	2,219	2,287	2,603	2,831
52227-M 	Mid-Back Lounge Chair, Wood Swivel Base 29.5" W x 29.5" D x 31.5" H Seat: 18" W x 18" D Seat Ht: 16.75" COM: 2 yds. COL: 40 sq. ft. 27 lbs.	1,897	2,025	2,095	2,137	2,203	2,275	2,339	2,407	2,473	2,541	2,857	3,085

OPTIONS

-PF02	Premium Metal Base Finish	\$101
-SM02	Super Matte Sable Wood Finish	\$23
-NS04	Non-Skid Glides	\$26





 = Available on quick-ship program (0535 Metallic Silver and 0299 Polished Aluminum base finishes only).

All shipments for this series will be blanket-wrapped as standard. For customers located in Territory 1 who require cartoning, a 5% upcharge will be added to each product. Please contact client services for additional information.

MELINA LOUNGE | Licensed from Wiesner Hager - Austria

ORDERING REQUIREMENTS:

- Model number
- Base finish
- Upholstery selection
- Options, as applicable

MODEL	PRODUCT SPECIFICATIONS	FABRIC GRADES										LEATHER	
		COM	A	1	2	3	4	COL 5	6	7	8	L1	L2
52223-H 	 High Back Lounge Chair, Metal Swivel Base 28.5" W x 25.75" D x 39.5" H Seat: 18" W x 18" D Seat Ht: 16.75" COM: 2.25 yds. COL: 45 sq. ft. 28 lbs.	1,919	2,063	2,142	2,189	2,264	2,345	2,417	2,493	2,567	2,644	2,999	3,256
52224-H 	High Back Lounge Chair, 4-Leg Wood Base 31.5" W x 31.5" D x 39.5" H Seat: 18" W x 18" D Seat Ht: 16.75" COM: 2.25 yds. COL: 45 sq. ft. 29 lbs.	1,783	1,927	2,006	2,053	2,128	2,209	2,281	2,357	2,431	2,508	2,863	3,120
52227-H 	High Back Lounge Chair, Wood Swivel Base 29.5" W x 29.5" D x 39.5" H Seat: 18" W x 18" D Seat Ht: 16.75" COM: 2.25 yds. COL: 45 sq. ft. 36 lbs.	2,006	2,150	2,229	2,276	2,351	2,432	2,504	2,580	2,654	2,731	3,086	3,343

OPTIONS

-PF02	Premium Metal Base Finish	\$101
-SM02	Super Matte Sable Wood Finish	\$23
-NS04	Non-Skid Glides	\$26

 = Available on quick-ship program (0535 Metallic Silver and 0299 Polished Aluminum base finishes only).

MELINA LOUNGE | Licensed from Wiesner Hager - Austria

UPHOLSTERY COMBINATIONS:

- For upholstery combinations, refer to the pricing below.
- When combining two COM/COV/COL fabrics, or fabrics with the same grade, add \$120 List per unit.
- When combining three or more COM/COV/COL fabrics, or fabrics with the same grade, add \$150 List per unit.
- When combining different grades of fabric, price will be based on the highest grade specified.
- Two-tone upholstery examples and yardage requirements for the most common combinations are listed below. Additional combinations available; please contact client Services for yardage requirements and pricing.
- Note: Yardage amounts are based on fabric which is plain (i.e. non-directional) and a full 54" wide.
- Appropriate upholstery code must be included.



Code	ML1
<u>Model</u>	<u>COM Requirement</u>
52223-M	Seat Cushion = 1 yd.
52224-M	Balance of Chair = 1.5 yds.
52227-M	



Code	ML2
<u>Model</u>	<u>COM Requirement</u>
52223-H	Seat Cushion = 1 yd.
52224-H	Balance of Chair = 1.75 yds.
52227-H	



Code	ML3
<u>Model</u>	<u>COM Requirement</u>
52223-M	Outside Back & Outside Arm Panel = 1 yd.
52224-M	Balance of Chair = 1.5 yds.
52227-M	



Code	ML4
<u>Model</u>	<u>COM Requirement</u>
52223-H	Outside Back & Outside Arm Panel = 1.25 yds.
52224-H	Balance of Chair = 1.5 yds.
52227-H	

All shipments for this series will be blanket-wrapped as standard. For customers located in Territory 1 who require cartoning, a 5% upcharge will be added to each product. Please contact client services for additional information.

MELINA MEETING TABLES | Licensed from Wiesner Hager - Austria



SPECIFICATIONS:

- Round and square top shapes offered in 29" and 42" heights.
- Five table surface options: wood veneer, laminate, Fenix, solid surface or Starphire® glass.
- Wood veneer available in all standard and custom finishes on Ash.
- For custom wood finishes, please contact client services and add one-time upcharge of \$531 List per color per order.
- For Super Matte Sable Ash finish, upcharge applies. Refer to option section for pricing.
- For custom laminate options, add \$649 List per color per order. Pre-approval required, please contact client services.
- Fenix offered in five standard colorways.
- For non-standard Fenix colors, please contact client services for pricing.
- Solid surface available in white only.
- For veneer, standard wood grain and solid black laminate, as well as Fenix Nero Ingo (black), edge will match top finish color, unless specified otherwise.
- For all other finishes, edge will be exposed plywood with a clear coat finish as standard.
- Glass tops are back-painted white as standard.
- Back-painted glass and solid surface tops feature exposed plywood substrate edge with clear coat finish.
- Column and base offered in standard and premium metal finishes. Please refer to listing below.
- All dimensions are nominal.
- Refer to terms and conditions for general information regarding finishes, warranty, freight, complete condition of sales and more.

STANDARD METAL COLUMN/BASE FINISH COLORS:

- 0405 Charcoal Grey
- 0535 Metallic Silver
- 0299 Polished Aluminum
- 0630 Satin Black

PREMIUM METAL COLUMN/BASE FINISH COLORS:

- 0605 Matte Black
- 0705 Matte Cotton
- 0788 Glossy Cotton
- 0805 Oasis
- 0905 Mint
- 1005 Mercury
- 1105 Canary
- 1205 Stone
- 1305 Sage
- 1405 Ice Blue
- 1505 Clay

All shipments for this series will be blanket-wrapped as standard. For customers located in Territory 1 who require cartoning, a 5% upcharge will be added to each product. Please contact client services for additional information.

MELINA MEETING TABLES | Licensed from Wiesner Hager - Austria

POWER NODE UNIT:

- Available on all top surfaces excluding glass.
- Power Node is 3-3/8" in diameter and 72" electrical cord.
- Chrome and white color options.
- Unless specified otherwise, unit will be positioned in center of table-top.



Power Node (PN1):

- One outlet, one USB-A and one USB-C charging port.

EDGE DETAIL:

Laminate*/Veneer/Fenix Top



Exposed Plywood Edge

Glass Top



1/2" Exposed Plywood Substrate

Solid Surface Top



1/2" Plywood Substrate

*Please note that laminate thickness is nominal and may vary.

All shipments for this series will be blanket-wrapped as standard. For customers located in Territory 1 who require cartoning, a 5% upcharge will be added to each product. Please contact client services for additional information.

MELINA MEETING TABLES | Licensed from Wiesner Hager - Austria

ORDERING REQUIREMENTS:

- Model number
- Top surface
- Top finish, as applicable
- Column/base finish
- Options, as applicable

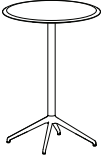
MODEL	veneER TOP (-V)	LAMINATE TOP (-L)	FENIX TOP (-FE)	SOLID SURFACE TOP (-SF)	BACK-PAINTED GLASS TOP (-GL)	WEIGHT
 <p>☼ Round Top, 29" Height</p> <p>5220-3029-()</p> <p>5220-3629-()</p> <p>5220-4229-()</p>	2,166	2,099	2,373	2,578	2,459	38 lbs.
	2,657	2,511	2,906	3,444	3,003	48 lbs.
	2,766	2,620	3,157	3,888	3,126	59 lbs.
 <p>☼ Round Top, 42" Height</p> <p>5220-3042-()</p> <p>5220-3642-()</p> <p>5220-4242-()</p>	2,308	2,250	2,524	2,729	2,612	38 lbs.
	2,797	2,662	3,057	3,595	3,164	48 lbs.
	2,904	2,772	3,309	4,040	3,283	59 lbs.

OPTIONS

- PF02 Premium Metal Base Finish \$101
- SM04 Super Matte Sable Wood Finish \$46
- PNI-() **☼** Power Node \$724
(Not available on models with glass tops)

Note: please specify (-C) for chrome and (-W) for white on Power Node Units.



☼ = Available on quick-ship program (veneer, laminate, Fenix and solid surface tops with 0535 Metallic Silver or 0299 Polished Aluminum base finishes only).

All shipments for this series will be blanket-wrapped as standard. For customers located in Territory 1 who require cartoning, a 5% upcharge will be added to each product. Please contact client services for additional information.

MELINA MEETING TABLES | Licensed from Wiesner Hager - Austria

ORDERING REQUIREMENTS:

- Model number
- Top surface
- Top finish, as applicable
- Column/base finish
- Options, as applicable

MODEL	veneER TOP (-V)	LAMINATE TOP (-L)	FENIX TOP (-FE)	SOLID SURFACE TOP (-SF)	BACK-PAINTED GLASS TOP (-GL)	WEIGHT
 <p>☼ Square Top, 29" Height</p>	5225-303029-()	2,100	2,374	2,579	2,494	38 lbs.
	5225-363629-()	2,513	2,908	3,446	3,050	48 lbs.
	5225-424229-()	2,625	3,162	3,893	3,169	59 lbs.
 <p>☼ Square Top, 42" Height</p>	5225-303042-()	2,253	2,527	2,732	2,652	42 lbs.
	5225-363642-()	2,664	3,059	3,597	3,205	52 lbs.
	5225-424242-()	2,775	3,312	4,043	3,327	63 lbs.

OPTIONS

- PF02 Premium Metal Base Finish \$101
- SM04 Super Matte Sable Wood Finish \$46
- PNI-() **☼** Power Node \$724
(Not available on models with glass tops)

Note: please specify (-C) for chrome and (-W) for white on Power Node Units.

☼ = Available on quick-ship program (veneer, laminate, Fenix and solid surface tops with 0535 Metallic Silver or 0299 Polished Aluminum base finishes only).

MELINA OCCASIONAL TABLES | Licensed from Wiesner Hager - Austria



SPECIFICATIONS:

- Round and square top shapes offered in 16" height.
- Four table surface options: wood veneer, laminate, Fenix solid surface or Starphire® glass.
- Wood veneer available in all standard and custom finishes on Ash.
- For custom wood finishes, please contact client services and add one-time upcharge of \$531 List per color per order.
- For Super Matte Sable Ash finish, upcharge applies. Refer to option section for pricing.
- For custom laminate options, add \$649 List per color per order. Pre-approval required, please contact client services.
- Fenix offered in five standard colorways.
- For non-standard Fenix colors, please contact client services for pricing.
- For veneer, standard wood grain and solid black laminate, as well as Fenix Nero Ingo (black), edge will match top finish color, unless specified otherwise.
- For all other finishes, edge will be exposed plywood with a clear coat finish as standard.
- Solid surface available in white only.
- Glass tops are back-painted white as standard.
- Back-painted glass and solid surface tops feature exposed plywood substrate edge with clear coat finish.
- Column and base offered in standard and premium metal finishes. Please refer to listing below.
- All dimensions are nominal.
- Refer to terms and conditions for general information regarding finishes, warranty, freight, complete condition of sales and more.

STANDARD METAL COLUMN/BASE FINISH COLORS:

- 0405 Charcoal Grey
- 0535 Metallic Silver
- 0299 Polished Aluminum
- 0630 Satin Black

PREMIUM METAL COLUMN/BASE FINISH COLORS:

- 0605 Matte Black
- 0705 Matte Cotton
- 0788 Glossy Cotton
- 0805 Oasis
- 0905 Mint
- 1005 Mercury
- 1105 Canary
- 1205 Stone
- 1305 Sage
- 1405 Ice Blue
- 1505 Clay

All shipments for this series will be blanket-wrapped as standard. For customers located in Territory 1 who require cartoning, a 5% upcharge will be added to each product. Please contact client services for additional information.

POWER NODE UNIT:

- Available on all top surfaces excluding glass.
- Power Node is 3-3/8" in diameter and 72" electrical cord.
- Chrome and white color options.
- Unless specified otherwise, unit will be positioned in center of table-top.



Power Node (PNI):

- One outlet, one USB-A and one USB-C charging port.

EDGE DETAIL:

Laminate*/Veneer/Fenix Top



Exposed Plywood Edge

Glass Top



1/4" Exposed Plywood Substrate

Solid Surface Top



1/4" Plywood Substrate



*Please note that laminate thickness is nominal and may vary.

All shipments for this series will be blanket-wrapped as standard. For customers located in Territory 1 who require cartoning, a 5% upcharge will be added to each product. Please contact client services for additional information.

MELINA OCCASIONAL TABLES | Licensed from Wiesner Hager - Austria

ORDERING REQUIREMENTS:

- Model number
- Top surface
- Top finish, as applicable
- Column/base finish
- Options, as applicable

MODEL	veneER TOP (-V)	LAMINATE TOP (-L)	FENIX TOP (-FE)	SOLID SURFACE TOP (-SF)	BACK-PAINTED GLASS TOP (-GL)	WEIGHT
 Round Top, 16" Height 5220-3016-() 5220-3616-() 5220-4216-()	1,966	1,877	2,151	2,356	2,239	34 lbs.
	2,458	2,289	2,684	3,222	2,776	44 lbs.
	2,564	2,400	2,937	3,668	2,906	55 lbs.
 Square Top, 16" Height 5225-303016-() 5225-363616-() 5225-424216-()	2,007	1,878	2,152	2,357	2,268	34 lbs.
	2,501	2,291	2,686	3,224	2,824	44 lbs.
	2,604	2,405	2,942	3,673	2,943	55 lbs.

OPTIONS

- PF02 Premium Metal Base Finish \$101
- SM04 Super Matte Sable Wood Finish \$46
- PN1-()  Power Node \$724
(Not available on models with glass tops)

Note: please specify (-C) for chrome and (-W) for white on Power Node Units.

 = Available on quick-ship program (veneer, laminate, Fenix and solid surface tops with 0535 Metallic Silver or 0299 Polished Aluminum base finishes only).

All shipments for this series will be cartoned as standard. If blanket-wrapped shipping is required, please contact client services for additional information.

MEMENTO EXECUTIVE



SPECIFICATIONS:

- Fully upholstered seat and back.
- Channel back stitching also offered.
- Armless, adjustable t-arm and polished aluminum cantilever arm models.
- Polished aluminum cantilever arm features black soft-touch arm cap.
- Optional fully polished aluminum cantilever arm without arm cap also available.
- Adjustable t-arms available with chrome trim detail.
- Adjustable t-arm features 4" arm height adjustment as standard.
- Fixed back height.
- Memory foam standard on seat.
- Swivel-tilt with tilt lock, synchro-tilt and synchro knee-tilt mechanisms available.
- Two base options: black nylon and polished aluminum.
- 300 lb. weight capacity.
- Ships KD (knocked down).
- All dimensions are nominal.
- Refer to terms and conditions for general information regarding fabrics, finishes, warranty, freight, complete condition of sales and more.



All shipments for this series will be cartoned as standard. If blanket-wrapped shipping is required, please contact client services for additional information.

MEMENTO EXECUTIVE

Swivel-Tilt with Tilt Lock Mechanism

ORDERING REQUIREMENTS:

- Model number
- Base finish
- Upholstery selection
- Options, as applicable

MODEL	PRODUCT SPECIFICATIONS	BASE FINISH	FABRIC GRADES										LEATHER	
			COM	A	1	2	3	4	COL 5	6	7	8	L1	L2
5551-U 	Ⓢ Upholstered Back, Armless 20" W x 22" D x 39"- 44" H Seat: 20.5" W x 18.5" D Seat Ht: 17" - 22" Back: 19" W x 24" H COM: 1.5 yds. COL: 30 sq. ft. 32 lbs.	Black Nylon	1,276	1,372	1,425	1,456	1,506	1,560	1,608	1,659	1,708	1,759	1,996	2,167
		Polished Aluminum	1,391	1,487	1,540	1,571	1,621	1,675	1,723	1,774	1,823	1,874	2,111	2,282
5553-U 	Ⓢ Upholstered Back, Adjustable T-Arms 27" W x 22" D x 39"- 44" H Seat: 20.5" W x 18.5" D Seat Ht: 17" - 22" Back: 19" W x 24" H COM: 1.5 yds. COL: 30 sq. ft. 38 lbs.	Black Nylon	1,483	1,579	1,632	1,663	1,713	1,767	1,815	1,866	1,915	1,966	2,203	2,374
		Polished Aluminum	1,598	1,694	1,747	1,778	1,828	1,882	1,930	1,981	2,030	2,081	2,318	2,489
5554-U 	Ⓢ Upholstered Back, Polished Aluminum Cantilever Arms 24.5" W x 22" D x 39"- 44" H Seat: 20.5" W x 18.5" D Seat Ht: 17" - 22" Back: 19" W x 24" H COM: 1.5 yds. COL: 30 sq. ft. 38 lbs.	Black Nylon	1,516	1,612	1,665	1,696	1,746	1,800	1,848	1,899	1,948	1,999	2,236	2,407
		Polished Aluminum	1,631	1,727	1,780	1,811	1,861	1,915	1,963	2,014	2,063	2,114	2,351	2,522

Note:
For two-tone upholstery, COM requirements are .75 yd. for seat and 1 yd. for back.

OPTIONS

-FP01	Fully Polished Arms (no arm cap) (5554-U model only)	\$80	-STLC02	Soft Tread Self-Locking Casters	\$63
-WA01	Width Adjustable Arms	\$38	-GD04	Glides	\$30
-PV01	Pivot Arms	\$71	-SK01	Stool Kit*	\$120
-STC02	Soft Tread Casters	\$33	-J01	Jury Base (black only)	\$199

* Stool models feature non-tilting mechanism.

Ⓢ = Available on quick-ship program.







All shipments for this series will be cartoned as standard. If blanket-wrapped shipping is required, please contact client services for additional information.

MEMENTO EXECUTIVE

Synchro Knee-Tilt Mechanism

ORDERING REQUIREMENTS:

- Model number
- Base finish
- Upholstery selection
- Options, as applicable

MODEL	PRODUCT SPECIFICATIONS	BASE FINISH	FABRIC GRADES								LEATHER			
			COM	A	1	2	3	4	COL 5	6	7	8	L1	L2
5581-U 	 Upholstered Back, Armless 20" W x 22" D x 39"- 44" H Seat: 20.5" W x 18.5" D Seat Ht: 17" - 22" Back: 19" W x 24" H COM: 1.5 yds. COL: 30 sq. ft. 34 lbs.	Black Nylon	1,509	1,605	1,658	1,689	1,739	1,793	1,841	1,892	1,941	1,992	2,229	2,400
		Polished Aluminum	1,624	1,720	1,773	1,804	1,854	1,908	1,956	2,007	2,056	2,107	2,344	2,515
5583-U 	 Upholstered Back, Adjustable T-Arms 27" W x 22" D x 39"- 44" H Seat: 20.5" W x 18.5" D Seat Ht: 17" - 22" Back: 19" W x 24" H COM: 1.5 yds. COL: 30 sq. ft. 40 lbs.	Black Nylon	1,716	1,812	1,865	1,896	1,946	2,000	2,048	2,099	2,148	2,199	2,436	2,607
		Polished Aluminum	1,831	1,927	1,980	2,011	2,061	2,115	2,163	2,214	2,263	2,314	2,551	2,722
5584-U 	 Upholstered Back, Polished Aluminum Cantilever Arms 24.5" W x 22" D x 39"- 44" H Seat: 20.5" W x 18.5" D Seat Ht: 17" - 22" Back: 19" W x 24" H COM: 1.5 yds. COL: 30 sq. ft. 40 lbs.	Black Nylon	1,749	1,845	1,898	1,929	1,979	2,033	2,081	2,132	2,181	2,232	2,469	2,640
		Polished Aluminum	1,864	1,960	2,013	2,044	2,094	2,148	2,196	2,247	2,296	2,347	2,584	2,755

Note:
For two-tone upholstery, COM requirements are .75 yd. for seat and 1 yd. for back.

OPTIONS

-FP01	Fully Polished Arms (no arm cap) (5584-U model only)	\$80	-STLC02	Soft Tread Self-Locking Casters	\$63
-WA01	Width Adjustable Arms	\$38	-GD04	Glides	\$30
-PV01	Pivot Arms	\$71	-J01	Jury Base (black only)	\$199
-STC02	Soft Tread Casters	\$33			

 = Available on quick-ship program.



All shipments for this series will be cartoned as standard. If blanket-wrapped shipping is required, please contact client services for additional information.

MEMENTO EXECUTIVE

Synchro-Tilt Mechanism

ORDERING REQUIREMENTS:

- Model number
- Base finish
- Upholstery selection
- Options, as applicable

MODEL	PRODUCT SPECIFICATIONS	BASE FINISH	FABRIC GRADES										LEATHER	
			COM	A	1	2	3	4	COL 5	6	7	8	L1	L2
5591-U 	Q/S Upholstered Back, Armless 20" W x 22" D x 39"- 44" H Seat: 20.5" W x 18.5" D Seat Ht: 17" - 22" Back: 19" W x 24" H COM: 1.5 yds. COL: 30 sq. ft. 32 lbs.	Black Nylon	1,349	1,445	1,498	1,529	1,579	1,633	1,681	1,732	1,781	1,832	2,069	2,240
		Polished Aluminum	1,464	1,560	1,613	1,644	1,694	1,748	1,796	1,847	1,896	1,947	2,184	2,355
5593-U 	Q/S Upholstered Back, Adjustable T-Arms 27" W x 22" D x 39"- 44" H Seat: 20.5" W x 18.5" D Seat Ht: 17" - 22" Back: 19" W x 24" H COM: 1.5 yds. COL: 30 sq. ft. 38 lbs.	Black Nylon	1,556	1,652	1,705	1,736	1,786	1,840	1,888	1,939	1,988	2,039	2,276	2,447
		Polished Aluminum	1,671	1,767	1,820	1,851	1,901	1,955	2,003	2,054	2,103	2,154	2,391	2,562
5594-U 	Q/S Upholstered Back, Polished Aluminum Cantilever Arms 24.5" W x 22" D x 39"- 44" H Seat: 20.5" W x 18.5" D Seat Ht: 17" - 22" Back: 19" W x 24" H COM: 1.5 yds. COL: 30 sq. ft. 38 lbs.	Black Nylon	1,589	1,685	1,738	1,769	1,819	1,873	1,921	1,972	2,021	2,072	2,309	2,480
		Polished Aluminum	1,704	1,800	1,853	1,884	1,934	1,988	2,036	2,087	2,136	2,187	2,424	2,595

Note:
 For two-tone upholstery, COM requirements are .75 yd. for seat and 1 yd. for back.

OPTIONS

-FP01	Fully Polished Arms (no arm cap) (5594-U model only)	\$80	-STC02	Soft Tread Casters	\$33
-WA01	Width Adjustable Arms	\$38	-STLC02	Soft Tread Self-Locking Casters	\$63
-PV01	Pivot Arms	\$71	-GD04	Glides	\$30
-SS01	Seat Slider	\$102	-J01	Jury Base (black only)	\$199

 = Available on quick-ship program.



All shipments for this series will be cartoned as standard. If blanket-wrapped shipping is required, please contact client services for additional information.

MEMENTO EXECUTIVE

Swivel-Tilt with Tilt Lock Mechanism

ORDERING REQUIREMENTS:

- Model number
- Base finish
- Upholstery selection
- Options, as applicable

MODEL	PRODUCT SPECIFICATIONS	BASE FINISH	FABRIC GRADES								LEATHER			
			COM	A	1	2	3	4	COL 5	6	7	8	L1	L2
5551-C 	Upholstered Channel Back, Armless 20" W x 22" D x 39"- 44" H Seat: 20.5" W x 18.5" D Seat Ht: 17" - 22" Back: 19" W x 24" H COM: 1.5 yds. COL: 30 sq. ft. 32 lbs.	Black Nylon	1,352	1,448	1,501	1,532	1,582	1,636	1,684	1,735	1,784	1,835	2,072	2,243
		Polished Aluminum	1,467	1,563	1,616	1,647	1,697	1,751	1,799	1,850	1,899	1,950	2,187	2,358
5553-C 	Upholstered Channel Back, Adjustable T-Arms 27" W x 22" D x 39"- 44" H Seat: 20.5" W x 18.5" D Seat Ht: 17" - 22" Back: 19" W x 24" H COM: 1.5 yds. COL: 30 sq. ft. 38 lbs.	Black Nylon	1,559	1,655	1,708	1,739	1,789	1,843	1,891	1,942	1,991	2,042	2,279	2,450
		Polished Aluminum	1,674	1,770	1,823	1,854	1,904	1,958	2,006	2,057	2,106	2,157	2,394	2,565
5554-C 	Upholstered Channel Back, Polished Aluminum Cantilever Arms 24.5" W x 22" D x 39"- 44" H Seat: 20.5" W x 18.5" D Seat Ht: 17" - 22" Back: 19" W x 24" H COM: 1.5 yds. COL: 30 sq. ft. 38 lbs.	Black Nylon	1,592	1,688	1,741	1,772	1,822	1,876	1,924	1,975	2,024	2,075	2,312	2,483
		Polished Aluminum	1,707	1,803	1,856	1,887	1,937	1,991	2,039	2,090	2,139	2,190	2,427	2,598

Note:
For two-tone upholstery, COM requirements are .75 yd. for seat and 1 yd. for back.

OPTIONS

-FP01	Fully Polished Arms (no arm cap) (5554-C model only)	\$80	-GD04	Glides	\$30
-WA01	Width Adjustable Arms	\$38	-SK01	Stool Kit*	\$120
-PV01	Pivot Arms	\$71	-J01	Jury Base (black only)	\$199
-STC02	Soft Tread Casters	\$33			
-STLC02	Soft Tread Self-Locking Casters	\$63			

* Stool models feature non-tilting mechanism.



All shipments for this series will be cartoned as standard. If blanket-wrapped shipping is required, please contact client services for additional information.

MEMENTO EXECUTIVE

Synchro Knee-Tilt Mechanism

ORDERING REQUIREMENTS:

- Model number
- Base finish
- Upholstery selection
- Options, as applicable

MODEL	PRODUCT SPECIFICATIONS	BASE FINISH	FABRIC GRADES								LEATHER			
			COM	A	1	2	3	4	COL 5	6	7	8	L1	L2
5581-C 	Upholstered Channel Back, Armless 20" W x 22" D x 39"- 44" H Seat: 20.5" W x 18.5" D Seat Ht: 17" - 22" Back: 19" W x 24" H COM: 1.5 yds. COL: 30 sq. ft. 34 lbs.	Black Nylon	1,583	1,679	1,732	1,763	1,813	1,867	1,915	1,966	2,015	2,066	2,303	2,474
		Polished Aluminum	1,698	1,794	1,847	1,878	1,928	1,982	2,030	2,081	2,130	2,181	2,418	2,589
5583-C 	Upholstered Channel Back, Adjustable T-Arms 27" W x 22" D x 39"- 44" H Seat: 20.5" W x 18.5" D Seat Ht: 17" - 22" Back: 19" W x 24" H COM: 1.5 yds. COL: 30 sq. ft. 40 lbs.	Black Nylon	1,790	1,886	1,939	1,970	2,020	2,074	2,122	2,173	2,222	2,273	2,510	2,681
		Polished Aluminum	1,905	2,001	2,054	2,085	2,135	2,189	2,237	2,288	2,337	2,388	2,625	2,796
5584-C 	Upholstered Channel Back, Polished Aluminum Cantilever Arms 24.5" W x 22" D x 39"- 44" H Seat: 20.5" W x 18.5" D Seat Ht: 17" - 22" Back: 19" W x 24" H COM: 1.5 yds. COL: 30 sq. ft. 40 lbs.	Black Nylon	1,823	1,919	1,972	2,003	2,053	2,107	2,155	2,206	2,255	2,306	2,543	2,714
		Polished Aluminum	1,938	2,034	2,087	2,118	2,168	2,222	2,270	2,321	2,370	2,421	2,658	2,829

Note:
For two-tone upholstery, COM requirements are .75 yd. for seat and 1 yd. for back.

OPTIONS

-FP01	Fully Polished Arms (no arm cap) (5584-C model only)	\$80	-STC02	Soft Tread Casters	\$33
-WA01	Width Adjustable Arms	\$38	-STLC02	Soft Tread Self-Locking Casters	\$63
-PV01	Pivot Arms	\$71	-GD04	Glides	\$30
			-J01	Jury Base (black only)	\$199



All shipments for this series will be cartoned as standard. If blanket-wrapped shipping is required, please contact client services for additional information.

MEMENTO EXECUTIVE

Synchro-Tilt Mechanism

ORDERING REQUIREMENTS:

- Model number
- Base finish
- Upholstery selection
- Options, as applicable

MODEL	PRODUCT SPECIFICATIONS	BASE FINISH	FABRIC GRADES								LEATHER			
			COM	A	1	2	3	4	COL 5	6	7	8	L1	L2
5591-C 	Upholstered Channel Back, Armless 20" W x 22" D x 39"- 44" H Seat: 20.5" W x 18.5" D Seat Ht: 17" - 22" Back: 19" W x 24" H COM: 1.5 yds. COL: 30 sq. ft. 32 lbs.	Black Nylon	1,407	1,503	1,556	1,587	1,637	1,691	1,739	1,790	1,839	1,890	2,127	2,298
		Polished Aluminum	1,522	1,618	1,671	1,702	1,752	1,806	1,854	1,905	1,954	2,005	2,242	2,413
5593-C 	Upholstered Channel Back, Adjustable T-Arms 27" W x 22" D x 39"- 44" H Seat: 20.5" W x 18.5" D Seat Ht: 17" - 22" Back: 19" W x 24" H COM: 1.5 yds. COL: 30 sq. ft. 38 lbs.	Black Nylon	1,614	1,710	1,763	1,794	1,844	1,898	1,946	1,997	2,046	2,097	2,334	2,505
		Polished Aluminum	1,729	1,825	1,878	1,909	1,959	2,013	2,061	2,112	2,161	2,212	2,449	2,620
5594-C 	Upholstered Channel Back, Polished Aluminum Cantilever Arms 24.5" W x 22" D x 39"- 44" H Seat: 20.5" W x 18.5" D Seat Ht: 17" - 22" Back: 19" W x 24" H COM: 1.5 yds. COL: 30 sq. ft. 38 lbs.	Black Nylon	1,647	1,743	1,796	1,827	1,877	1,931	1,979	2,030	2,079	2,130	2,367	2,538
		Polished Aluminum	1,762	1,858	1,911	1,942	1,992	2,046	2,094	2,145	2,194	2,245	2,482	2,653

Note:
 For two-tone upholstery, COM requirements are .75 yd. for seat and 1 yd. for back.

OPTIONS

-FP01	Fully Polished Arms (no arm cap) (5594-C model only)	\$80	-STC02	Soft Tread Casters	\$33
-SS01	Seat Slider	\$102	-STLC02	Soft Tread Self-Locking Casters	\$63
-WA01	Width Adjustable Arms	\$38	-GD04	Glides	\$30
-PV01	Pivot Arms	\$71	-J01	Jury Base (black only)	\$199

All shipments for this series will be cartoned as standard. If blanket-wrapped shipping is required, please contact client services for additional information.

MEMENTO TASK



SPECIFICATIONS:

- Fully upholstered back and seat.
- Channel back stitching also offered.
- Armless, adjustable t-arm and polished aluminum cantilever arm models.
- Polished aluminum cantilever arm features black soft-touch arm cap.
- Adjustable t-arms available with chrome trim detail.
- Adjustable t-arm features 4" arm height adjustment as standard.
- 2½" back height adjustment.
- Memory foam standard on seat.
- Swivel-tilt with tilt lock, task intensive and synchro-tilt mechanism.
- Stool models feature non-tilting mechanism.
- Two base options: black nylon and polished aluminum.
- 300 lb. weight capacity.
- Ships KD (knocked down).
- All dimensions are nominal.
- Refer to terms and conditions for general information regarding fabrics, finishes, warranty, freight, complete condition of sales and more.



All shipments for this series will be cartoned as standard. If blanket-wrapped shipping is required, please contact client services for additional information.

MEMENTO TASK

Task Intensive Mechanism

ORDERING REQUIREMENTS:

- Model number
- Base finish
- Upholstery selection
- Options, as applicable

MODEL	PRODUCT SPECIFICATIONS	BASE FINISH	FABRIC GRADES										LEATHER	
			COM	A	1	2	3	4	COL 5	6	7	8	L1	L2
5641-U 	☒ Upholstered Back, Armless 20" W x 22" D x 34.5"- 39.5" H Seat: 20.5" W x 18" D Seat Ht: 17" - 22" Back: 18.5" W x 20" H COM: 1.5 yds. COL: 30 sq. ft. 44 lbs.	Black Nylon	1,291	1,387	1,440	1,471	1,521	1,575	1,623	1,674	1,723	1,774	2,011	2,182
		Polished Aluminum	1,406	1,502	1,555	1,586	1,636	1,690	1,738	1,789	1,838	1,889	2,126	2,297
5643-U 	☒ Upholstered Back, Adjustable T-Arms 27" W x 22" D x 34.5"- 39.5" H Seat: 20.5" W x 18" D Seat Ht: 17" - 22" Back: 18.5" W x 20" H COM: 1.5 yds. COL: 30 sq. ft. 50 lbs.	Black Nylon	1,498	1,594	1,647	1,678	1,728	1,782	1,830	1,881	1,930	1,981	2,218	2,389
		Polished Aluminum	1,613	1,709	1,762	1,793	1,843	1,897	1,945	1,996	2,045	2,096	2,333	2,504
5644-U 	☒ Upholstered Back, Polished Aluminum Cantilever Arms 24.5" W x 22" D x 34.5"- 39.5" H Seat: 20.5" W x 18" D Seat Ht: 17" - 22" Back: 18.5" W x 20" H COM: 1.5 yds. COL: 30 sq. ft. 50 lbs.	Black Nylon	1,531	1,627	1,680	1,711	1,761	1,815	1,863	1,914	1,963	2,014	2,251	2,422
		Polished Aluminum	1,646	1,742	1,795	1,826	1,876	1,930	1,978	2,029	2,078	2,129	2,366	2,537

Note:
For two-tone upholstery, COM requirements are .75 yd. for seat and 1 yd. for back.

OPTIONS

-FP01	Fully Polished Arms (no arm cap) (5644-U model only)	\$80	-STC02	Soft Tread Casters	\$33
-SS01	Seat Slider	\$102	-STLC02	Soft Tread Self-Locking Casters	\$63
-WA01	Width Adjustable Arms	\$38	-GD04	Glides	\$30
-PV01	Pivot Arms	\$71	-J01	Jury Base (black only)	\$199

☒ = Available on quick-ship program.



All shipments for this series will be cartoned as standard. If blanket-wrapped shipping is required, please contact client services for additional information.

MEMENTO TASK

Swivel-Tilt with Tilt Lock Mechanism

ORDERING REQUIREMENTS:

- Model number
- Base finish
- Upholstery selection
- Options, as applicable

MODEL	PRODUCT SPECIFICATIONS	BASE FINISH	FABRIC GRADES								LEATHER			
			COM	A	1	2	3	4	COL 5	6	7	8	L1	L2
5651-U 	☉ Upholstered Back, Armless 20" W x 22" D x 34.5"- 39.5" H Seat: 20.5" W x 18" D Seat Ht: 17" - 22" Back: 18.5" W x 20" H COM: 1.5 yds. COL: 30 sq. ft. 36 lbs.	Black Nylon	1,207	1,303	1,356	1,387	1,437	1,491	1,539	1,590	1,639	1,690	1,927	2,098
		Polished Aluminum	1,322	1,418	1,471	1,502	1,552	1,606	1,654	1,705	1,754	1,805	2,042	2,213
5653-U 	☉ Upholstered Back, Adjustable T-Arms 27" W x 22" D x 34.5"- 39.5" H Seat: 20.5" W x 18" D Seat Ht: 17" - 22" Back: 18.5" W x 20" H COM: 1.5 yds. COL: 30 sq. ft. 42 lbs.	Black Nylon	1,414	1,510	1,563	1,594	1,644	1,698	1,746	1,797	1,846	1,897	2,134	2,305
		Polished Aluminum	1,529	1,625	1,678	1,709	1,759	1,813	1,861	1,912	1,961	2,012	2,249	2,420
5654-U 	☉ Upholstered Back, Polished Aluminum Cantilever Arms 24.5" W x 22" D x 34.5"- 39.5" H Seat: 20.5" W x 18" D Seat Ht: 17" - 22" Back: 18.5" W x 20" H COM: 1.5 yds. COL: 30 sq. ft. 42 lbs.	Black Nylon	1,447	1,543	1,596	1,627	1,677	1,731	1,779	1,830	1,879	1,930	2,167	2,338
		Polished Aluminum	1,562	1,658	1,711	1,742	1,792	1,846	1,894	1,945	1,994	2,045	2,282	2,453

Note:
For two-tone upholstery, COM requirements are .75 yd. for seat and 1 yd. for back.

OPTIONS

-FP01	Fully Polished Arms (no arm cap) (5654-U model only)	\$80	-STLC02	Soft Tread Self-Locking Casters	\$63
-SS01	Seat Slider	\$102	-GD04	Glides	\$30
-WA01	Width Adjustable Arms	\$38	-SK01	Stool Kit ¹	\$120
-PV01	Pivot Arms	\$71	-J01	Jury Base (black only)	\$199
-STC02	Soft Tread Casters	\$33			

¹ Stool models feature non-tilting mechanism.

☉ = Available on quick-ship program.



All shipments for this series will be cartoned as standard. If blanket-wrapped shipping is required, please contact client services for additional information.

MEMENTO TASK

Synchro-Tilt Mechanism

ORDERING REQUIREMENTS:

- Model number
- Base finish
- Upholstery selection
- Options, as applicable

MODEL	PRODUCT SPECIFICATIONS	BASE FINISH	FABRIC GRADES										LEATHER	
			COM	A	1	2	3	4	COL 5	6	7	8	L1	L2
5691-U 	Upholstered Back, Armless 20" W x 22" D x 34.5"- 39.5" H Seat: 20.5" W x 18" D Seat Ht: 17" - 22" Back: 18.5" W x 20" H COM: 1.5 yds. COL: 30 sq. ft. 37 lbs.	Black Nylon	1,266	1,362	1,415	1,446	1,496	1,550	1,598	1,649	1,698	1,749	1,986	2,157
		Polished Aluminum	1,381	1,477	1,530	1,561	1,611	1,665	1,713	1,764	1,813	1,864	2,101	2,272
5693-U 	Upholstered Back, Adjustable T-Arms 27" W x 22" D x 34.5"- 39.5" H Seat: 20.5" W x 18" D Seat Ht: 17" - 22" Back: 18.5" W x 20" H COM: 1.5 yds. COL: 30 sq. ft. 43 lbs.	Black Nylon	1,473	1,569	1,622	1,653	1,703	1,757	1,805	1,856	1,905	1,956	2,193	2,364
		Polished Aluminum	1,588	1,684	1,737	1,768	1,818	1,872	1,920	1,971	2,020	2,071	2,308	2,479
5694-U 	Upholstered Back, Polished Aluminum Cantilever Arms 24.5" W x 22" D x 34.5"- 39.5" H Seat: 20.5" W x 18" D Seat Ht: 17" - 22" Back: 18.5" W x 20" H COM: 1.5 yds. COL: 30 sq. ft. 43 lbs.	Black Nylon	1,506	1,602	1,655	1,686	1,736	1,790	1,838	1,889	1,938	1,989	2,226	2,397
		Polished Aluminum	1,621	1,717	1,770	1,801	1,851	1,905	1,953	2,004	2,053	2,104	2,341	2,512

Note:
For two-tone upholstery, COM requirements are .75 yd. for seat and 1 yd. for back.

OPTIONS

-FP01	Fully Polished Arms (no arm cap) (5694-U model only)	\$80	-STC02	Soft Tread Casters	\$33
-SS01	Seat Slider	\$102	-STLC02	Soft Tread Self-Locking Casters	\$63
-WA01	Width Adjustable Arms	\$38	-GD04	Glides	\$30
-PV01	Pivot Arms	\$71	-J01	Jury Base (black only)	\$199

* Stool models feature non-tilting mechanism.

☞ = Available on quick-ship program.



All shipments for this series will be cartoned as standard. If blanket-wrapped shipping is required, please contact client services for additional information.

MEMENTO TASK

Task Intensive Mechanism

ORDERING REQUIREMENTS:

- Model number
- Base finish
- Upholstery selection
- Options, as applicable

MODEL	PRODUCT SPECIFICATIONS	BASE FINISH	FABRIC GRADES								LEATHER			
			COM	A	1	2	3	4	COL 5	6	7	8	L1	L2
5641-C 	Upholstered Channel Back, Armless 20" W x 22" D x 34.5"- 39.5" H Seat: 20.5" W x 18" D Seat Ht: 17" - 22" Back: 18.5" W x 20" H COM: 1.5 yds. COL: 30 sq. ft. 44 lbs.	Black Nylon	1,442	1,538	1,591	1,622	1,672	1,726	1,774	1,825	1,874	1,925	2,162	2,333
		Polished Aluminum	1,557	1,653	1,706	1,737	1,787	1,841	1,889	1,940	1,989	2,040	2,277	2,448
5643-C 	Upholstered Channel Back, Adjustable T-Arms 27" W x 22" D x 34.5"- 39.5" H Seat: 20.5" W x 18" D Seat Ht: 17" - 22" Back: 18.5" W x 20" H COM: 1.5 yds. COL: 30 sq. ft. 50 lbs.	Black Nylon	1,649	1,745	1,798	1,829	1,879	1,933	1,981	2,032	2,081	2,132	2,369	2,540
		Polished Aluminum	1,764	1,860	1,913	1,944	1,994	2,048	2,096	2,147	2,196	2,247	2,484	2,655
5644-C 	Upholstered Channel Back, Polished Aluminum Cantilever Arms 24.5" W x 22" D x 34.5"- 39.5" H Seat: 20.5" W x 18" D Seat Ht: 17" - 22" Back: 18.5" W x 20" H COM: 1.5 yds. COL: 30 sq. ft. 50 lbs.	Black Nylon	1,682	1,778	1,831	1,862	1,912	1,966	2,014	2,065	2,114	2,165	2,402	2,573
		Polished Aluminum	1,797	1,893	1,946	1,977	2,027	2,081	2,129	2,180	2,229	2,280	2,517	2,688

Note:
For two-tone upholstery, COM requirements are .75 yd. for seat and 1 yd. for back.

OPTIONS

-FP01	Fully Polished Arms (no arm cap) (5644-C model only)	\$80	-STLC02	Soft Tread Self-Locking Casters	\$63
-SS01	Seat Slider	\$102	-GD04	Glides	\$30
-WA01	Width Adjustable Arms	\$38	-J01	Jury Base (black only)	\$199
-PV01	Pivot Arms	\$71			
-STC02	Soft Tread Casters	\$33			



All shipments for this series will be cartoned as standard. If blanket-wrapped shipping is required, please contact client services for additional information.

MEMENTO TASK

Swivel-Tilt with Tilt Lock Mechanism

ORDERING REQUIREMENTS:

- Model number
- Base finish
- Upholstery selection
- Options, as applicable

MODEL	PRODUCT SPECIFICATIONS	BASE FINISH	FABRIC GRADES								LEATHER			
			COM	A	1	2	3	4	COL 5	6	7	8	L1	L2
5651-C 	Upholstered Channel Back, Armless 20" W x 22" D x 34.5"- 39.5" H Seat: 20.5" W x 18" D Seat Ht: 17" - 22" Back: 18.5" W x 20" H COM: 1.5 yds. COL: 30 sq. ft. 36 lbs.	Black Nylon	1,369	1,465	1,518	1,549	1,599	1,653	1,701	1,752	1,801	1,852	2,089	2,260
		Polished Aluminum	1,484	1,580	1,633	1,664	1,714	1,768	1,816	1,867	1,916	1,967	2,204	2,375
5653-C 	Upholstered Channel Back, Adjustable T-Arms 27" W x 22" D x 34.5"- 39.5" H Seat: 20.5" W x 18" D Seat Ht: 17" - 22" Back: 18.5" W x 20" H COM: 1.5 yds. COL: 30 sq. ft. 42 lbs.	Black Nylon	1,576	1,672	1,725	1,756	1,806	1,860	1,908	1,959	2,008	2,059	2,296	2,467
		Polished Aluminum	1,691	1,787	1,840	1,871	1,921	1,975	2,023	2,074	2,123	2,174	2,411	2,582
5654-C 	Upholstered Channel Back, Polished Aluminum Cantilever Arms 24.5" W x 22" D x 34.5"- 39.5" H Seat: 20.5" W x 18" D Seat Ht: 17" - 22" Back: 18.5" W x 20" H COM: 1.5 yds. COL: 30 sq. ft. 42 lbs.	Black Nylon	1,609	1,705	1,758	1,789	1,839	1,893	1,941	1,992	2,041	2,092	2,329	2,500
		Polished Aluminum	1,724	1,820	1,873	1,904	1,954	2,008	2,056	2,107	2,156	2,207	2,444	2,615

Note:
For two-tone upholstery, COM requirements are .75 yd. for seat and 1 yd. for back.

OPTIONS

-FP01	Fully Polished Arms (no arm cap) (5654-C model only)	\$80	-STLC02	Soft Tread Self-Locking Casters	\$63
-SS01	Seat Slider	\$102	-GD04	Glides	\$30
-WA01	Width Adjustable Arms	\$38	-SK01	Stool Kit ¹	\$120
-PV01	Pivot Arms	\$71	-J01	Jury Base (black only)	\$199
-STC02	Soft Tread Casters	\$33			

¹ Stool models feature non-tilting mechanism.



All shipments for this series will be cartoned as standard. If blanket-wrapped shipping is required, please contact client services for additional information.

MEMENTO TASK

Synchro-Tilt Mechanism

ORDERING REQUIREMENTS:

- Model number
- Base finish
- Upholstery selection
- Options, as applicable

MODEL	PRODUCT SPECIFICATIONS	BASE FINISH	FABRIC GRADES								LEATHER			
			COM	A	1	2	3	4	COL 5	6	7	8	L1	L2
5691-C 	Upholstered Channel Back, Armless 20" W x 22" D x 34.5"- 39.5" H Seat: 20.5" W x 18" D Seat Ht: 17" - 22" Back: 18.5" W x 20" H COM: 1.5 yds. COL: 30 sq. ft. 37 lbs.	Black Nylon	1,428	1,524	1,577	1,608	1,658	1,712	1,760	1,811	1,860	1,911	2,148	2,319
		Polished Aluminum	1,543	1,639	1,692	1,723	1,773	1,827	1,875	1,926	1,975	2,026	2,263	2,434
5693-C 	Upholstered Channel Back, Adjustable T-Arms 27" W x 22" D x 34.5"- 39.5" H Seat: 20.5" W x 18" D Seat Ht: 17" - 22" Back: 18.5" W x 20" H COM: 1.5 yds. COL: 30 sq. ft. 43 lbs.	Black Nylon	1,635	1,731	1,784	1,815	1,865	1,919	1,967	2,018	2,067	2,118	2,355	2,526
		Polished Aluminum	1,750	1,846	1,899	1,930	1,980	2,034	2,082	2,133	2,182	2,233	2,470	2,641
5694-C 	Upholstered Channel Back, Polished Aluminum Cantilever Arms 24.5" W x 22" D x 34.5"- 39.5" H Seat: 20.5" W x 18" D Seat Ht: 17" - 22" Back: 18.5" W x 20" H COM: 1.5 yds. COL: 30 sq. ft. 43 lbs.	Black Nylon	1,668	1,764	1,817	1,848	1,898	1,952	2,000	2,051	2,100	2,151	2,388	2,559
		Polished Aluminum	1,783	1,879	1,932	1,963	2,013	2,067	2,115	2,166	2,215	2,266	2,503	2,674

Note:
For two-tone upholstery, COM requirements are .75 yd. for seat and 1 yd. for back.

OPTIONS

-FP01	Fully Polished Arms (no arm cap) (5694-C model only)	\$80	-STC02	Soft Tread Casters	\$33
-SS01	Seat Slider	\$102	-STLC02	Soft Tread Self-Locking Casters	\$63
-WA01	Width Adjustable Arms	\$38	-GD04	Glides	\$30
-PV01	Pivot Arms	\$71	-J01	Jury Base (black only)	\$199

MOZIE GUEST



SPECIFICATIONS:

- Arm and armless models with open upholstered back.
- Arms feature black finish as standard.
- Silver arm finish also available. Please specify (-SA01) after model number and add \$32 list.
- Elliptical tubular steel frame.
- Frame available in standard and premium finishes. See below for options.
- Available with glides or on casters.
- Single guest chairs with glides or casters stack up to 4 high standing or 5 with dolly.
- Dolly not recommended for caster models.
- Guest chairs feature 400 lb. weight capacity.
- Bariatric models feature enhanced seat and back size and 750 lb. weight capacity.
- Optional ganging bracket available for chair to chair connection.
- Please note that to gang two chairs together, separate ganging brackets must be ordered for each unit.
- Ganging brackets fold under seat when not in use.
- If cartoning is required, chairs are packaged in units of two (2). A \$20 List carton break charge will be applied for orders with only one chair.
- All dimensions are nominal.
- Refer to terms and conditions for general information regarding fabrics, finishes, warranty, freight, complete condition of sales and more.

STANDARD METAL BASE FINISH COLORS:

- 0405 Charcoal Grey
- 0535 Metallic Silver
- 0630 Satin Black

PREMIUM METAL BASE FINISH COLORS:





- 0605 Matte Black
- 0705 Matte Cotton
- 0788 Glossy Cotton
- 0805 Oasis
- 0905 Mint
- 1005 Mercury
- 1105 Canary
- 1205 Stone
- 1305 Sage
- 1405 Ice Blue
- 1505 Clay

All shipments for this series will be blanket-wrapped as standard. For customers located in Territory 1 who require cartoning, a 5% upcharge will be added to each product. Please contact client services for additional information.

MOZIE GUEST

ORDERING REQUIREMENTS:

- Model number
- Arm finish
- Frame finish
- Upholstery selection
- Options, as applicable

MODEL	PRODUCT SPECIFICATIONS	FABRIC GRADES								LEATHER			
		COM	A	1	2	3	4	COL 5	6	7	8	L1	L2
2715 	 Guest Chair, Arms, Casters 24" W x 25" D x 32" H Seat: 19.5" W x 18" D Seat Ht: 18" Arm Ht: 25.5" COM: 1.5 yds. COL: 30 sq. ft. 28 lbs.	771	867	920	951	1,001	1,055	1,103	1,154	1,203	1,254	1,491	1,662
2735 	 Guest Chair, Armless, Casters 21.5" W x 25" D x 32" H Seat: 19.5" W x 18" D Seat Ht: 18" COM: 1.5 yds. COL: 30 sq. ft. 26 lbs.	704	800	853	884	934	988	1,036	1,087	1,136	1,187	1,424	1,595

OPTIONS

-PF02	Premium Metal Frame Finish	\$101	-EF01	1" Additional Seat Foam	\$44
-SA01	Silver Arms	\$32	-MB01	Moisture Barrier (seat only)	\$68
-STC02	Soft Tread Casters	\$33			
-GC05	Ganging Connector (per chair)	\$42			





 = Available on quick-ship program (0535 Metallic Silver base finish only).

All shipments for this series will be blanket-wrapped as standard. For customers located in Territory 1 who require cartoning, a 5% upcharge will be added to each product. Please contact client services for additional information.

MOZIE GUEST

ORDERING REQUIREMENTS:

- Model number
- Arm finish
- Frame finish
- Upholstery selection
- Options, as applicable

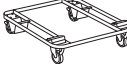
MODEL	PRODUCT SPECIFICATIONS	FABRIC GRADES								LEATHER			
		COM	A	1	2	3	4	COL 5	6	7	8	L1	L2
2710 	 Guest Chair, Arms, Glides 24" W x 25" D x 32" H Seat: 19.5" W x 18" D Seat Ht: 18" Arm Ht: 25.5" COM: 1.5 yds. COL: 30 sq. ft. 28 lbs.	765	861	914	945	995	1,049	1,097	1,148	1,197	1,248	1,485	1,656
2730 	 Guest Chair, Armless, Glides 21.5" W x 25" D x 32" H Seat: 19.5" W x 18" D Seat Ht: 18" COM: 1.5 yds. COL: 30 sq. ft. 26 lbs.	699	795	848	879	929	983	1,031	1,082	1,131	1,182	1,419	1,590
2500 	Dolly (Black Finish Only) 24" W x 30" D x 6" H Weight: 37 lbs.	435											

OPTIONS

-PF02	Premium Metal Frame Finish	\$101	-MB01	Moisture Barrier (seat only)	\$68
-SA01	Silver Arms	\$32	-WS	Wall-Saver Leg	n/c
-GC05	Ganging Connector (per chair)	\$42			
-EF01	1" Additional Seat Foam	\$44			

 = Available on quick-ship program (0535 Metallic Silver base finish only).

All shipments for this series will be blanket-wrapped as standard. For customers located in Territory 1 who require cartoning, a 5% upcharge will be added to each product. Please contact client services for additional information.

MOZIE GUEST

ORDERING REQUIREMENTS:

- Model number
- Arm finish
- Frame finish
- Upholstery selection
- Options, as applicable

MODEL	PRODUCT SPECIFICATIONS	FABRIC GRADES								LEATHER			
		COM	A	1	2	3	4	COL 5	6	7	8	L1	L2
2780 	Bariatric Chair, Arms, Glides 34.5" W x 26" D x 33" H Seat: 30" W x 18" D Seat Ht: 19" Arm Ht: 26.5" COM: 2.25 yds. COL: 45 sq. ft. 55 lbs.	1,215	1,359	1,438	1,485	1,560	1,641	1,713	1,789	1,863	1,940	2,295	2,552

OPTIONS

-PF02	Premium Metal Frame Finish	\$101
-SA01	Silver Arms	\$32
-EF02	1" Additional Seat Foam	\$98
-MB02	Moisture Barrier (seat only)	\$89
-WS	Wall-Saver Leg	n/c

All shipments for this series will be blanket-wrapped as standard. For customers located in Territory 1 who require cartoning, a 5% upcharge will be added to each product. Please contact client services for additional information.

MOZIE GUEST

UPHOLSTERY COMBINATIONS:

- For upholstery combinations, refer to the pricing below.
- When combining two COM/COV/COL fabrics, or fabrics with the same grade, add \$120 List per unit.
- When combining three or more COM/COV/COL fabrics, or fabrics with the same grade, add \$150 List per unit.
- When combining different grades of fabric, price will be based on the highest grade specified.
- Two-tone upholstery examples and yardage requirements for the most common combinations are listed below. Additional combinations available; please contact client services for yardage requirements and pricing.
- Note: Yardage amounts are based on fabric which is plain (i.e. non-directional) and a full 54" wide.
- Appropriate upholstery code must be included.



Code	MO1
<u>Model</u>	<u>COM Requirement</u>
2710	Seat = 1 yd.
2715	Back = 1 yd.
2730	
2735	

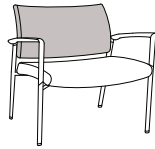

Code	MO2
<u>Model</u>	<u>COM Requirement</u>
2780	Seat = 1.25 yds.
	Back = 1.25 yds.

MOZIE OCCASIONAL TABLES



SPECIFICATIONS:

- Square and rectangular top shapes.
- Laminate and solid surface top material options.
- Laminate tops are $\frac{3}{4}$ " thick, solid surface tops are $\frac{1}{2}$ " thick.
- Laminate available in all standard colors.
- For custom laminate options, add \$649 List per color per order. Pre-approval required, please contact client services.
- Solid surface available in white only.
- Self edge standard. PVC edge also available in three colors. See below for options.
- Round metal legs available in standard and premium finishes. Refer to options below.
- Apron will match leg finish unless specified otherwise.
- All dimensions are nominal.
- Refer to terms and conditions for general information regarding fabrics, finishes, warranty, freight, complete condition of sales and more.

STANDARD METAL BASE FINISH COLORS:

- 0405 Charcoal Grey
- 0535 Metallic Silver
- 0630 Satin Black

PREMIUM METAL BASE FINISH COLORS:

- 0605 Matte Black
- 0705 Matte Cotton
- 0788 Glossy Cotton
- 0805 Oasis
- 0905 Mint
- 1005 Mercury
- 1105 Canary
- 1205 Stone
- 1305 Sage
- 1405 Ice Blue
- 1505 Clay

PVC EDGE COLORS:

- White
- Slate Grey
- Black

All shipments for this series will be blanket-wrapped as standard. For customers located in Territory 1 who require cartoning, a 5% upcharge will be added to each product. Please contact client services for additional information.

MOZIE OCCASIONAL TABLES

ORDERING REQUIREMENTS:

- Model number
- Table top finish
- PVC edge color, as applicable
- Leg finish
- Options, as applicable

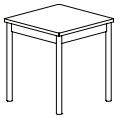
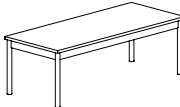
	MODEL	DIMENSIONS	LAMINATE TOP (-L)	SOLID SURFACE TOP (-SF)	WEIGHT
	Square Table				
	270-181820-()	18" W x 18" D x 20" H	938	1,112	16 lbs.
	270-222220-()	22" W x 22" D x 20" H	1,033	1,339	20 lbs.
	270-303020-()	30" W x 30" D x 20" H	1,298	1,777	25 lbs.
	Rectangular Table				
	270-482016-()	48" W x 20" D x 16" H	1,410	2,239	36 lbs.

OPTIONS

-PF02 Premium Metal Leg Finish \$101

NEXXT GUEST | Designed by Francisco Romero of PhiDesign



SPECIFICATIONS:

- Two arm options: armless or signature black arms.
- Elliptical tubular steel frame.
- Two frame finish options: 0535 Metallic Silver or 0630 Satin Black.
- For custom finish colors, please contact client services for pricing.
- Wall-saver leg design.
- Available with glides or on casters.
- Chairs with glides or casters stack up to 4 high standing or 5 with dolly.
- Optional ganging device available.
- If cartoning is required, chairs are packaged in units of three (3). A \$20 List carton break charge will be applied for orders with only one or two chairs.
- 300 lb. weight capacity.
- All dimensions are nominal.
- Refer to terms and conditions for general information regarding fabrics, finishes, warranty, freight, complete condition of sales and more.

STANDARD METAL FRAME FINISH COLORS:









- 0535 Metallic Silver
- 0630 Satin Black

All shipments for this series will be blanket-wrapped as standard. For customers located in Territory 1 who require cartoning, a 5% upcharge will be added to each product. Please contact client services for additional information.

NEXXT GUEST | Designed by Francisco Romero of PhiDesign

ORDERING REQUIREMENTS:

- Model number
- Frame finish
- Upholstery selection
- Options, as applicable

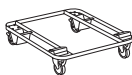
MODEL	PRODUCT SPECIFICATIONS	FABRIC GRADES										LEATHER	
		COM	A	1	2	3	4	COL 5	6	7	8	L1	L2
3210 	 Guest/Stack Chair, Fully Upholstered, Arms, Glides 24" W x 23" D x 33" H Seat: 17.25" W x 18.25" D Seat Ht: 18" Arm Ht: 27.75" COM: 1.25 yds. COL: 25 sq. ft. 28 lbs.	685	765	809	835	877	922	962	1,004	1,045	1,088	1,285	1,428
3215 	 Guest/Stack Chair, Fully Upholstered, Arms, Casters 24" W x 23" D x 33" H Seat: 17.25" W x 18.25" D Seat Ht: 18" Arm Ht: 27.75" COM: 1.25 yds. COL: 25 sq. ft. 28 lbs.	689	769	813	839	881	926	966	1,008	1,049	1,092	1,289	1,432
3230 	 Guest/Stack Chair, Fully Upholstered, Armless, Glides 22.5" W x 23" D x 33" H Seat: 17.25" W x 18.25" D Seat Ht: 18" COM: 1.25 yds. COL: 25 sq. ft. 26 lbs.	643	723	767	793	835	880	920	962	1,003	1,046	1,243	1,386
3235 	 Guest/Stack Chair, Fully Upholstered, Armless, Casters 22.5" W x 23" D x 33" H Seat: 17.25" W x 18.25" D Seat Ht: 18" COM: 1.25 yds. COL: 25 sq. ft. 26 lbs.	642	722	766	792	834	879	919	961	1,002	1,045	1,242	1,385
2500 	Dolly (Black Finish Only) 24" W x 30" D x 6" H Weight: 37 lbs.	435											

OPTIONS

-EF01	1" Additional Seat Foam	\$44
-STC02	Soft Tread Casters	\$33
-GC06	Ganging Connector	\$42

 = Available on quick-ship program (0535 Metallic Silver base finishes only).

All shipments for this series will be blanket-wrapped as standard. For customers located in Territory 1 who require cartoning, a 5% upcharge will be added to each product. Please contact client services for additional information.

NEXXT GUEST | Designed by Francisco Romero of PhiDesign

UPHOLSTERY COMBINATIONS:

- For upholstery combinations, refer to the pricing below.
- When combining two COM/COV/COL fabrics, or fabrics with the same grade, add \$120 List per unit.
- When combining three or more COM/COV/COL fabrics, or fabrics with the same grade, add \$150 List per unit.
- When combining different grades of fabric, price will be based on the highest grade specified.
- Two-tone upholstery examples and yardage requirements for the most common combinations are listed below. Additional combinations available; please contact client services for yardage requirements and pricing.
- Note: Yardage amounts are based on fabric which is plain (i.e. non-directional) and a full 54" wide.
- Appropriate upholstery code must be included.



Code	NX2
<u>Model</u>	<u>COM Requirement</u>
3210	Seat = .75 yd.
3215	Back = .75 yd.
3230	
3235	

All shipments for this series will be blanket-wrapped as standard. For customers located in Territory 1 who require cartoning, a 5% upcharge will be added to each product. Please contact client services for additional information.

NEXXT NESTING | Designed by Francisco Romero of PhiDesign



SPECIFICATIONS:

- Two arm options: armless or signature black arms.
- Elliptical tubular steel frame.
- Two frame finish options: 0535 Metallic Silver or 0630 Satin Black.
- For custom finish colors, please contact client services for pricing.
- Wall-saver leg design.
- Arm and armless chairs stack up to 4 high standing.
- Arm and armless chair seat flips up to allow nesting capabilities.
- If cartoning is required, chairs are packaged in units of three (3). A \$20 List carton break charge will be applied for orders with only one or two chairs.
- 300 lb. weight capacity.
- All dimensions are nominal.
- Refer to terms and conditions for general information regarding fabrics, finishes, warranty, freight, complete condition of sales and more.

STANDARD METAL FRAME FINISH COLORS:





- 0535 Metallic Silver
- 0630 Satin Black

All shipments for this series will be blanket-wrapped as standard. For customers located in Territory 1 who require cartoning, a 5% upcharge will be added to each product. Please contact client services for additional information.

NEXXT NESTING | Designed by Francisco Romero of PhiDesign

ORDERING REQUIREMENTS:

- Model number
- Frame finish
- Upholstery selection
- Options, as applicable

MODEL	PRODUCT SPECIFICATIONS	FABRIC GRADES										LEATHER	
		COM	A	1	2	3	4	COL 5	6	7	8	L1	L2
3115 	<p> Nesting/Stack Chair, Fully Upholstered, Arms, Casters</p> <p>24" W x 23" D x 33" H Seat: 17.25" W x 18.25" D Seat Ht: 18" Arm Ht: 27.75" COM: 1.25 yds. COL: 25 sq. ft. 28 lbs.</p>	799	879	923	949	991	1,036	1,076	1,118	1,159	1,202	1,399	1,542
3135 	<p> Nesting/Stack Chair, Fully Upholstered, Armless, Casters</p> <p>22.5" W x 23" D x 33" H Seat: 17.25" W x 18.25" D Seat Ht: 18" COM: 1.25 yds. COL: 25 sq. ft. 26 lbs.</p>	732	812	856	882	924	969	1,009	1,051	1,092	1,135	1,332	1,475

OPTIONS

- EF01 1" Additional Seat Foam \$44
- STC02 Soft Tread Casters \$33

 = Available on quick-ship program (0535 Metallic Silver base finish only).

All shipments for this series will be blanket-wrapped as standard. For customers located in Territory 1 who require cartoning, a 5% upcharge will be added to each product. Please contact client services for additional information.

NEXXT NESTING | Designed by Francisco Romero of PhiDesign

UPHOLSTERY COMBINATIONS:

- For upholstery combinations, refer to the pricing below.
- When combining two COM/COV/COL fabrics, or fabrics with the same grade, add \$120 List per unit.
- When combining three or more COM/COV/COL fabrics, or fabrics with the same grade, add \$150 List per unit.
- When combining different grades of fabric, price will be based on the highest grade specified.
- Two-tone upholstery examples and yardage requirements for the most common combinations are listed below. Additional combinations available; please contact client services for yardage requirements and pricing.
- Note: Yardage amounts are based on fabric which is plain (i.e. non-directional) and a full 54" wide.
- Appropriate upholstery code must be included.



Code	NX1
<u>Model</u>	<u>COM Requirement</u>
All	Seat = .75 yd. Back = .75 yd.

All shipments for this series will be cartoned as standard. If blanket-wrapped shipping is required, please contact client services for additional information.

NEXXT TASK | Designed by Francisco Romero of PhiDesign



SPECIFICATIONS:

- Armless and fixed cantilever arm models.
- Elliptical tubular steel frame.
- Two frame finish options: 0535 Metallic Silver or 0630 Satin Black.
- Fixed back height.
- Two base options: black nylon and polished aluminum.
- Black nylon base option reduces seat height by 1".
- 300 lb. weight capacity.
- Ships KD (knocked down).
- All dimensions are nominal.
- Swivel and swivel-tilt with tilt lock mechanisms available.
- Refer to terms and conditions for general information regarding fabrics, finishes, warranty, freight, complete condition of sales and more.

STANDARD METAL FRAME FINISH COLORS:

- 0535 Metallic Silver
- 0630 Satin Black



All shipments for this series will be cartoned as standard. If blanket-wrapped shipping is required, please contact client services for additional information.

NEXXT TASK | Designed by Francisco Romero of PhiDesign

Non-Tilt, Height Adjustable Swivel Mechanism

ORDERING REQUIREMENTS:

- Model number
- Frame finish
- Base finish
- Upholstery selection
- Options, as applicable

MODEL	PRODUCT SPECIFICATIONS	BASE FINISH	FABRIC GRADES								LEATHER			
			COM	A	1	2	3	4	COL 5	6	7	8	L1	L2
3311 	Fully Upholstered, Armless 18.5" W x 23.5" D x 33.5" - 38.5" H Seat: 18.5" W x 18.25" D Seat Ht: 17" - 22" Back: 17.75" W x 15" H COM: 1.25 yds. COL: 25 sq. ft. 35 lbs.	Black Nylon	973	1,053	1,097	1,123	1,165	1,210	1,250	1,292	1,333	1,376	1,573	1,716
		Polished Aluminum	1,088	1,168	1,212	1,238	1,280	1,325	1,365	1,407	1,448	1,491	1,688	1,831
3314 	Fully Upholstered, Fixed Cantilever Arms 24" W x 23.5" D x 33.5" - 38.5" H Seat: 18.5" W x 18.25" D Seat Ht: 17" - 22" Back: 17.75" W x 15" H COM: 1.25 yds. COL: 25 sq. ft. 37 lbs.	Black Nylon	1,047	1,127	1,171	1,197	1,239	1,284	1,324	1,366	1,407	1,450	1,647	1,790
		Polished Aluminum	1,162	1,242	1,286	1,312	1,354	1,399	1,439	1,481	1,522	1,565	1,762	1,905

OPTIONS

-EF01	1" Additional Seat Foam	\$44
-STC02	Soft Tread Casters	\$33
-STLC02	Soft Tread Self-Locking Casters	\$63
-GDO4	Glides	\$30
-J01	Jury Base (black only)	\$199



All shipments for this series will be cartoned as standard. If blanket-wrapped shipping is required, please contact client services for additional information.

NEXXT TASK | Designed by Francisco Romero of PhiDesign

Swivel-Tilt with Tilt Lock Mechanism

ORDERING REQUIREMENTS:

- Model number
- Frame finish
- Base finish
- Upholstery selection
- Options, as applicable

MODEL	PRODUCT SPECIFICATIONS	BASE FINISH	FABRIC GRADES								LEATHER			
			COM	A	1	2	3	4	COL 5	6	7	8	L1	L2
3351 	Fully Upholstered, Armless 18.5" W x 23.5" D x 33.5" - 38.5" H Seat: 18.5" W x 18.25" D Seat Ht: 17" - 22" Back: 17.75" W x 15" H COM: 1.25 yds. COL: 25 sq. ft. 35 lbs.	Black Nylon	1,037	1,117	1,161	1,187	1,229	1,274	1,314	1,356	1,397	1,440	1,637	1,780
		Polished Aluminum	1,152	1,232	1,276	1,302	1,344	1,389	1,429	1,471	1,512	1,555	1,752	1,895
3354 	Fully Upholstered, Fixed Cantilever Arms 24" W x 23.5" D x 33.5" - 38.5" H Seat: 18.5" W x 18.25" D Seat Ht: 17" - 22" Back: 17.75" W x 15" H COM: 1.25 yds. COL: 25 sq. ft. 37 lbs.	Black Nylon	1,088	1,168	1,212	1,238	1,280	1,325	1,365	1,407	1,448	1,491	1,688	1,831
		Polished Aluminum	1,203	1,283	1,327	1,353	1,395	1,440	1,480	1,522	1,563	1,606	1,803	1,946

OPTIONS

-EF01	1" Additional Seat Foam	\$44
-STC02	Soft Tread Casters	\$33
-STLC02	Soft Tread Self-Locking Casters	\$63
-GDO4	Glides	\$30
-J01	Jury Base (black only)	\$199

NOTION



SPECIFICATIONS:

- Armless, adjustable t-arm and signature fixed aluminum arm models.
- Adjustable t-arm features 3" arm height travel and chrome trim detail as standard.
- Fixed aluminum arm available with Beech wood or black urethane arm caps.
- Wood arm caps offered in all standard finishes on Beech
- For Super Matte Sable Beech finish, upcharge applies. Refer to option section for pricing.
- Fixed aluminum arm features 0299 Polished Aluminum finish as standard. 0405 Charcoal Grey and 0535 Metallic Silver finishes also available at no upcharge, please specify.
- 8" stool travel.
- 2½" back height adjustment on low back models.
- Mid- and high back models feature fixed back height.
- Two base options: black nylon and polished aluminum.
- 300 lb. weight capacity.
- Ships KD (knocked down).
- All dimensions are nominal.
- Synchro knee-tilt and swivel-tilt with tilt lock mechanisms available.
- Refer to terms and conditions for general information regarding fabrics, finishes, warranty, freight, complete condition of sales and more.





All shipments for this series will be cartoned as standard. If blanket-wrapped shipping is required, please contact client services for additional information.

NOTION

Swivel-Tilt with Tilt Lock Mechanism

ORDERING REQUIREMENTS:

- Model number
- Arm cap finish, as applicable
- Base finish
- Upholstery selection
- Options, as applicable

MODEL	PRODUCT SPECIFICATIONS	BASE FINISH	FABRIC GRADES								LEATHER			
			COM	A	1	2	3	4	COL 5	6	7	8	L1	L2
4251-L 	Low Back, Armless 20" W x 23.5" D x 33.5" - 37.5" H Seat: 20" W x 18.5" D Seat Ht: 17" - 21" Back: 19.5" W x 19" - 21.5" H COM: 1.5 yds. COL: 30 sq. ft. 40 lbs.	Black Nylon	1,145	1,241	1,294	1,325	1,375	1,429	1,477	1,528	1,577	1,628	1,865	2,036
		Polished Aluminum	1,260	1,356	1,409	1,440	1,490	1,544	1,592	1,643	1,692	1,743	1,980	2,151
4253-L 	Low Back, Adjustable T-Arms 26" W x 23.5" D x 33.5" - 37.5" H Seat: 20" W x 18.5" D Seat Ht: 17" - 21" Back: 19.5" W x 19" - 21.5" H COM: 1.5 yds. COL: 30 sq. ft. 42 lbs.	Black Nylon	1,233	1,329	1,382	1,413	1,463	1,517	1,565	1,616	1,665	1,716	1,953	2,124
		Polished Aluminum	1,348	1,444	1,497	1,528	1,578	1,632	1,680	1,731	1,780	1,831	2,068	2,239
4254-L-U 	Low Back, Fixed Aluminum Arms, Black Urethane Arm Caps 24.5" W x 23.5" D x 33.5" - 37.5" H Seat: 20" W x 18.5" D Seat Ht: 17" - 21" Back: 19.5" W x 19" - 21.5" H COM: 1.5 yds. COL: 30 sq. ft. 42 lbs.	Black Nylon	1,390	1,486	1,539	1,570	1,620	1,674	1,722	1,773	1,822	1,873	2,110	2,281
		Polished Aluminum	1,505	1,601	1,654	1,685	1,735	1,789	1,837	1,888	1,937	1,988	2,225	2,396
4254-L-W 	Low Back, Fixed Aluminum Arms, Beech Wood Arm Caps 24.5" W x 23.5" D x 33.5" - 37.5" H Seat: 20" W x 18.5" D Seat Ht: 17" - 21" Back: 19.5" W x 19" - 21.5" H COM: 1.5 yds. COL: 30 sq. ft. 42 lbs.	Black Nylon	1,519	1,615	1,668	1,699	1,749	1,803	1,851	1,902	1,951	2,002	2,239	2,410
		Polished Aluminum	1,634	1,730	1,783	1,814	1,864	1,918	1,966	2,017	2,066	2,117	2,354	2,525

OPTIONS

-SM01	Super Matte Sable Wood Finish	\$12
-GD04	Glides	\$30
-STC02	Soft Tread Casters	\$33
-J01	Jury Base (black only)	\$199





All shipments for this series will be cartoned as standard. If blanket-wrapped shipping is required, please contact client services for additional information.

NOTION

Swivel-Tilt with Tilt Lock Mechanism

ORDERING REQUIREMENTS:

- Model number
- Arm cap finish, as applicable
- Base finish
- Upholstery selection
- Options, as applicable

MODEL	PRODUCT SPECIFICATIONS	BASE FINISH	FABRIC GRADES								LEATHER			
			COM	A	1	2	3	4	COL 5	6	7	8	L1	L2
4251-M 	Mid-Back, Armless 20" W x 23.5" D x 40" - 44" H Seat: 20" W x 18.5" D Seat Ht: 17" - 21" Back: 20" W x 24" H COM: 1.75 yds. COL: 35 sq. ft. 41 lbs.	Black Nylon	1,176	1,288	1,350	1,386	1,444	1,507	1,563	1,623	1,680	1,740	2,016	2,216
		Polished Aluminum	1,291	1,403	1,465	1,501	1,559	1,622	1,678	1,738	1,795	1,855	2,131	2,331
4253-M 	Mid-Back, Adjustable T-Arms 26" W x 23.5" D x 40" - 44" H Seat: 20" W x 18.5" D Seat Ht: 17" - 21" Back: 20" W x 24" H COM: 1.75 yds. COL: 35 sq. ft. 43 lbs.	Black Nylon	1,263	1,375	1,437	1,473	1,531	1,594	1,650	1,710	1,767	1,827	2,103	2,303
		Polished Aluminum	1,378	1,490	1,552	1,588	1,646	1,709	1,765	1,825	1,882	1,942	2,218	2,418
4254-M-U 	Mid-Back, Fixed Aluminum Arms, Black Urethane Arm Caps 24.5" W x 23.5" D x 40" - 44" H Seat: 20" W x 18.5" D Seat Ht: 17" - 21" Back: 20" W x 24" H COM: 1.75 yds. COL: 35 sq. ft. 43 lbs.	Black Nylon	1,419	1,531	1,593	1,629	1,687	1,750	1,806	1,866	1,923	1,983	2,259	2,459
		Polished Aluminum	1,534	1,646	1,708	1,744	1,802	1,865	1,921	1,981	2,038	2,098	2,374	2,574
4254-M-W 	Mid-Back, Fixed Aluminum Arms, Beech Wood Arm Caps 24.5" W x 23.5" D x 40" - 44" H Seat: 20" W x 18.5" D Seat Ht: 17" - 21" Back: 20" W x 24" H COM: 1.75 yds. COL: 31.5 sq. ft. 43 lbs.	Black Nylon	1,548	1,660	1,722	1,758	1,816	1,879	1,935	1,995	2,052	2,112	2,388	2,588
		Polished Aluminum	1,663	1,775	1,837	1,873	1,931	1,994	2,050	2,110	2,167	2,227	2,503	2,703

OPTIONS

-SM01	Super Matte Sable Wood Finish	\$12
-GDO4	Glides	\$30
-STC02	Soft Tread Casters	\$33
-J01	Jury Base (black only)	\$199





All shipments for this series will be cartoned as standard. If blanket-wrapped shipping is required, please contact client services for additional information.

NOTION

Swivel-Tilt with Tilt Lock Mechanism

ORDERING REQUIREMENTS:

- Model number
- Arm cap finish, as applicable
- Base finish
- Upholstery selection
- Options, as applicable

MODEL	PRODUCT SPECIFICATIONS	BASE FINISH	FABRIC GRADES								LEATHER			
			COM	A	1	2	3	4	COL 5	6	7	8	L1	L2
4251-H 	High Back, Armless 20" W x 23.5" D x 46" - 50" H Seat: 20" W x 18.5" D Seat Ht: 17" - 21" Back: 20" W x 30" H COM: 2 yds. COL: 40 sq. ft. 42 lbs.	Black Nylon	1,218	1,346	1,416	1,458	1,524	1,596	1,660	1,728	1,794	1,862	2,178	2,406
		Polished Aluminum	1,333	1,461	1,531	1,573	1,639	1,711	1,775	1,843	1,909	1,977	2,293	2,521
4253-H 	High Back, Adjustable T-Arms 26" W x 23.5" D x 46" - 50" H Seat: 20" W x 18.5" D Seat Ht: 17" - 21" Back: 20" W x 30" H COM: 2 yds. COL: 40 sq. ft. 44 lbs.	Black Nylon	1,307	1,435	1,505	1,547	1,613	1,685	1,749	1,817	1,883	1,951	2,267	2,495
		Polished Aluminum	1,422	1,550	1,620	1,662	1,728	1,800	1,864	1,932	1,998	2,066	2,382	2,610
4254-H-U 	High Back, Fixed Aluminum Arms, Black Urethane Arm Caps 24.5" W x 23.5" D x 46" - 50" H Seat: 20" W x 18.5" D Seat Ht: 17" - 21" Back: 20" W x 30" H COM: 2 yds. COL: 40 sq. ft. 44 lbs.	Black Nylon	1,464	1,592	1,662	1,704	1,770	1,842	1,906	1,974	2,040	2,108	2,424	2,652
		Polished Aluminum	1,579	1,707	1,777	1,819	1,885	1,957	2,021	2,089	2,155	2,223	2,539	2,767
4254-H-W 	High Back, Fixed Aluminum Arms, Beech Wood Arm Caps 24.5" W x 23.5" D x 46" - 50" H Seat: 20" W x 18.5" D Seat Ht: 17" - 21" Back: 20" W x 30" H COM: 2 yds. COL: 40 sq. ft. 44 lbs.	Black Nylon	1,593	1,721	1,791	1,833	1,899	1,971	2,035	2,103	2,169	2,237	2,553	2,781
		Polished Aluminum	1,708	1,836	1,906	1,948	2,014	2,086	2,150	2,218	2,284	2,352	2,668	2,896

OPTIONS

-SM01	Super Matte Sable Wood Finish	\$12
-GDO4	Glides	\$30
-STC02	Soft Tread Casters	\$33
-J01	Jury Base (black only)	\$199





All shipments for this series will be cartoned as standard. If blanket-wrapped shipping is required, please contact client services for additional information.

NOTION

Synchro Knee-Tilt Mechanism

ORDERING REQUIREMENTS:

- Model number
- Arm cap finish, as applicable
- Base finish
- Upholstery selection
- Options, as applicable

MODEL	PRODUCT SPECIFICATIONS	BASE FINISH	FABRIC GRADES								LEATHER			
			COM	A	1	2	3	4	COL 5	6	7	8	L1	L2
4281-M 	Mid-Back, Armless 20" W x 23.5" D x 40" - 43" H Seat: 20" W x 18.5" D Seat Ht: 17" - 20" Back: 20" W x 24" H COM: 1.75 yds. COL: 35 sq. ft. 48 lbs.	Black Nylon	1,422	1,534	1,596	1,632	1,690	1,753	1,809	1,869	1,926	1,986	2,262	2,462
		Polished Aluminum	1,537	1,649	1,711	1,747	1,805	1,868	1,924	1,984	2,041	2,101	2,377	2,577
4283-M 	Mid-Back, Adjustable T-Arms 26" W x 23.5" D x 40" - 43" H Seat: 20" W x 18.5" D Seat Ht: 17" - 20" Back: 20" W x 24" H COM: 1.75 yds. COL: 35 sq. ft. 50 lbs.	Black Nylon	1,511	1,623	1,685	1,721	1,779	1,842	1,898	1,958	2,015	2,075	2,351	2,551
		Polished Aluminum	1,626	1,738	1,800	1,836	1,894	1,957	2,013	2,073	2,130	2,190	2,466	2,666
4284-M-U 	Mid-Back, Fixed Aluminum Arms, Black Urethane Arm Caps 24.5" W x 23.5" D x 40" - 43" H Seat: 20" W x 18.5" D Seat Ht: 17" - 20" Back: 20" W x 24" H COM: 1.75 yds. COL: 35 sq. ft. 50 lbs.	Black Nylon	1,670	1,782	1,844	1,880	1,938	2,001	2,057	2,117	2,174	2,234	2,510	2,710
		Polished Aluminum	1,785	1,897	1,959	1,995	2,053	2,116	2,172	2,232	2,289	2,349	2,625	2,825
4284-M-W 	Mid-Back, Fixed Aluminum Arms, Beech Wood Arm Caps 24.5" W x 23.5" D x 40" - 43" H Seat: 20" W x 18.5" D Seat Ht: 17" - 20" Back: 20" W x 24" H COM: 1.75 yds. COL: 35 sq. ft. 50 lbs.	Black Nylon	1,799	1,911	1,973	2,009	2,067	2,130	2,186	2,246	2,303	2,363	2,639	2,839
		Polished Aluminum	1,914	2,026	2,088	2,124	2,182	2,245	2,301	2,361	2,418	2,478	2,754	2,954

OPTIONS

-SM01	Super Matte Sable Wood Finish	\$12
-GD04	Glides	\$30
-STC02	Soft Tread Casters	\$33
-J01	Jury Base (black only)	\$199





All shipments for this series will be cartoned as standard. If blanket-wrapped shipping is required, please contact client services for additional information.

NOTION

Synchro Knee-Tilt Mechanism

ORDERING REQUIREMENTS:

- Model number
- Arm cap finish, as applicable
- Base finish
- Upholstery selection
- Options, as applicable

MODEL	PRODUCT SPECIFICATIONS	BASE FINISH	FABRIC GRADES								LEATHER			
			COM	A	1	2	3	4	COL 5	6	7	8	L1	L2
4281-H 	High Back, Armless 20" W x 23.5" D x 46" - 49" H Seat: 20" W x 18.5" D Seat Ht: 17" - 20" Back: 20" W x 30" H COM: 2 yds. COL: 40 sq. ft. 49 lbs.	Black Nylon	1,461	1,589	1,659	1,701	1,767	1,839	1,903	1,971	2,037	2,105	2,421	2,649
		Polished Aluminum	1,576	1,704	1,774	1,816	1,882	1,954	2,018	2,086	2,152	2,220	2,536	2,764
4283-H 	High Back, Adjustable T-Arms 26" W x 23.5" D x 46" - 49" H Seat: 20" W x 18.5" D Seat Ht: 17" - 20" Back: 20" W x 30" H COM: 2 yds. COL: 40 sq. ft. 51 lbs.	Black Nylon	1,556	1,684	1,754	1,796	1,862	1,934	1,998	2,066	2,132	2,200	2,516	2,744
		Polished Aluminum	1,671	1,799	1,869	1,911	1,977	2,049	2,113	2,181	2,247	2,315	2,631	2,859
4284-H-U 	High Back, Fixed Aluminum Arms, Black Urethane Arm Caps 24.5" W x 23.5" D x 46" - 49" H Seat: 20" W x 18.5" D Seat Ht: 17" - 20" Back: 20" W x 30" H COM: 2 yds. COL: 40 sq. ft. 51 lbs.	Black Nylon	1,712	1,840	1,910	1,952	2,018	2,090	2,154	2,222	2,288	2,356	2,672	2,900
		Polished Aluminum	1,827	1,955	2,025	2,067	2,133	2,205	2,269	2,337	2,403	2,471	2,787	3,015
4284-H-W 	High Back, Fixed Aluminum Arms, Beech Wood Arm Caps 24.5" W x 23.5" D x 46" - 49" H Seat: 20" W x 18.5" D Seat Ht: 17" - 20" Back: 20" W x 30" H COM: 2 yds. COL: 40 sq. ft. 51 lbs.	Black Nylon	1,841	1,969	2,039	2,081	2,147	2,219	2,283	2,351	2,417	2,485	2,801	3,029
		Polished Aluminum	1,956	2,084	2,154	2,196	2,262	2,334	2,398	2,466	2,532	2,600	2,916	3,144

OPTIONS

-SM01	Super Matte Sable Wood Finish	\$12
-GDO4	Glides	\$30
-STC02	Soft Tread Casters	\$33
-J01	Jury Base (black only)	\$199

All shipments for this series will be blanket-wrapped as standard. For customers located in Territory 1 who require cartoning, a 5% upcharge will be added to each product. Please contact client services for additional information.

PIXIE STOOLS | Designed by Qdesign



SPECIFICATIONS:

- 30" height with triangular seat.
- ½" diameter steel rod frame.
- Frame available in standard and premium finishes. Please refer to listing below.
- For custom finish colors, please contact client services for pricing.
- 350 lb. weight capacity.
- Optional clear glides for hard surface flooring.
- All dimensions are nominal.
- Refer to terms and conditions for general information regarding fabrics, finishes, warranty, freight, complete condition of sales and more.

STANDARD METAL FRAME FINISH COLORS:

- 0405 Charcoal Grey
- 0535 Metallic Silver
- 0199 Chrome
- 0630 Satin Black

PREMIUM METAL FRAME FINISH COLORS:



- 0605 Matte Black
- 0705 Matte Cotton
- 0788 Glossy Cotton
- 0805 Oasis
- 0905 Mint
- 1005 Mercury
- 1105 Canary
- 1205 Stone
- 1305 Sage
- 1405 Ice Blue
- 1505 Clay

All shipments for this series will be blanket-wrapped as standard. For customers located in Territory 1 who require cartoning, a 5% upcharge will be added to each product. Please contact client services for additional information.

PIXIE STOOLS | Designed by Qdesign

ORDERING REQUIREMENTS:

- Model number
- Frame finish
- Upholstery selection
- Options, as applicable

MODEL	PRODUCT SPECIFICATIONS	FABRIC GRADES										LEATHER	
		COM	A	1	2	3	4	COL 5	6	7	8	L1	L2
1020-30 	 30" Bar-Height Stool 18.5" W x 15.5" D x 31" H Seat: 14" W x 13.25" D Seat Ht: 31" COM: .5 yd. COL: 10 sq. ft. 12 lbs.	649	681	699	709	726	744	760	777	793	810	889	946

OPTIONS

- PF02 Premium Metal Frame Finish \$101
- CG03 Clear Glides (set of 6) \$17

 = Available on quick-ship program (0535 Metallic Silver or 0199 Chrome base finishes only).

All shipments for this series will be blanket-wrapped as standard. For customers located in Territory 1 who require cartoning, a 5% upcharge will be added to each product. Please contact client services for additional information.

PLAYGROUND OCCASIONAL TABLES | Designed by Chris Panichella



SPECIFICATIONS:

- Round, square and rectangular top shapes.
- Wood veneer and laminate top surface options.
- Three wood species available: Beech, White Oak and Walnut.
- For custom wood finishes, please contact client services and add one-time upcharge of \$531 List per color per order.
- For Super Matte Sable finish on Beech or White Oak, upcharge applies. Refer to option section for pricing.
- For custom laminate options, add \$649 List per color per order. Pre-approval required, please contact client services.
- For standard wood grain laminate or solid black laminate tops, edge will match unless specified otherwise.
- For all other solid laminates, edge will be exposed plywood substrate with clear coat finish.
- Metal legs offered in standard and premium finishes. Please refer to listing below.
- For custom finish colors, please contact client services for pricing.
- Optional 16" diameter fixed second-tier table offered in wood veneer or laminate.
- Second-tier table finish will match table-top finish unless specified otherwise.
- **Please note that second-tier table is only available on round and oval table sizes 29" diameter/width and larger. It is not available on square tables, rectangular tables or round table 7270-2116.**
- All dimensions are nominal.
- Refer to terms and conditions for general information regarding fabrics, finishes, warranty, freight, complete condition of sales and more.

STANDARD METAL LEG FINISH COLORS:

- 0405 Charcoal Grey
- 0535 Metallic Silver
- 0199 Chrome
- 0630 Satin Black

PREMIUM METAL LEG FINISH COLORS:



- 0605 Matte Black
- 0705 Matte Cotton
- 0788 Glossy Cotton
- 0805 Oasis
- 0905 Mint
- 1005 Mercury
- 1105 Canary
- 1205 Stone
- 1305 Sage
- 1405 Ice Blue
- 1505 Clay

All shipments for this series will be blanket-wrapped as standard. For customers located in Territory 1 who require cartoning, a 5% upcharge will be added to each product. Please contact client services for additional information.

PLAYGROUND OCCASIONAL TABLES | Designed by Chris Panichella

ORDERING REQUIREMENTS:

- Model number
- Top surface
- Top finish
- Leg finish
- Options, as applicable

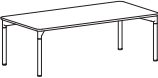
	MODEL	DIMENSIONS	WOOD (-V) OR LAMINATE (-L) TOP	WEIGHT
	Round Table			
	7270-2116-()	21" Dia. x 16" H	967	15 lbs.
	7270-2916-()	29" Dia. x 16" H	1,429	21 lbs.
	7270-3616-()	36" Dia. x 16" H	1,797	28 lbs.
	7270-4216-()	42" Dia. x 16" H	1,873	33 lbs.
	Oval Table			
	7275-362416-()	36" W x 24" D x 16" H	1,428	26 lbs.
	7275-462416-()	46" W x 24" D x 16" H	1,648	22 lbs.
	Square Table			
	7280-222216-()	22" W x 22" D x 16" H	967	26 lbs.
	7280-303016-()	30" W x 30" D x 16" H	1,429	22 lbs.
	7280-363616-()	36" W x 36" D x 16" H	1,797	28 lbs.
	7280-424216-()	42" W x 42" D x 16" H	1,873	33 lbs.
	Rectangular Table			
7280-482416-()	48" W x 24" D x 16" H	1,648	34 lbs.	

OPTIONS

-PF02	Premium Metal Leg Finish	\$101
-SM04	Super Matte Sable Wood Finish*	\$46
-NS04	Non-Skid Glides	\$26
-STX02-W	Wood Second-Tier Table	\$527
-STX02-L	Laminate Second-Tier Table	\$527

*Second-tier table, if specified, will match as standard with no additional upcharge.

All shipments for this series will be blanket-wrapped as standard. For customers located in Territory 1 who require cartoning, a 5% upcharge will be added to each product. Please contact client services for additional information.

PLAYGROUND MODULAR | Designed by Chris Panichella



SPECIFICATIONS:

- Metal frame available in standard and premium finishes. See following pages for options.
- For custom metal finish colors, please contact client services for pricing.
- Optional power units available for placement under seating units.
- Multiple bench sizes and shapes offered with or without backrest, available individually or in modular combinations.
- Optional ganging connector offered for modular configurations. Please specify "GCO7" with quantity and add \$66 List per set.
- Single seat benches feature 350 lb. weight capacity.
- Two-seat benches feature 600 lb. weight capacity.
- Please include layout drawings or sketch with each modular order.
- All dimensions are nominal.
- Refer to terms and conditions for general information regarding fabrics, finishes, warranty, freight, complete condition of sales and more.

ROTATING TABLET:

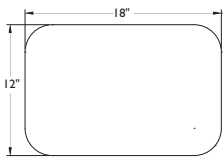

- Available on select modular bench units.
- Tablet size is 18" W x 12" D x .75" thick and features 360-degree turning radius.
- Two tablet surface options: wood veneer and laminate.
- Three wood species available: Beech, White Oak and Walnut.
- For custom wood finishes, please contact client services and add one-time upcharge of \$531 List per color per order.
- For Super Matte Sable finish on Beech or White Oak, upcharge applies. Refer to option section for pricing.
- For custom laminate options, add \$649 List per color per order. Pre-approval required, please contact client services.
- For standard wood grain laminate or solid black laminate tops, edge will match unless specified otherwise.
- For all other solid laminates, edge will be exposed plywood substrate with clear coat finish.
- Tablet mounting post will match frame/leg finish unless specified otherwise.
- Please note that tablet is not available on modular corner units due to space limitations.

PLAYGROUND MODULAR | Designed by Chris Panichella

STATIONARY TABLE-ETTE:

- Available on select modular bench units.
- Table-ette size is 12" dia. x .75" thick.
- Two table-ette surface options: wood veneer and laminate.
- Three wood species available: Beech, White Oak and Walnut.
- For custom wood finishes, please contact client services and add one-time upcharge of \$531 List per color per order.
- For Super Matte Sable finish on Beech or White Oak, upcharge applies. Refer to option section for pricing.
- For custom laminate options, add \$649 List per color per order. Pre-approval required, please contact client services.
- For standard wood grain laminate or solid black laminate tops, edge will match unless specified otherwise.
- For all other solid laminates, edge will be exposed plywood substrate with clear coat finish.
- Table-ette mounting post will match frame/leg finish unless specified otherwise.
- Please note that center placement for is only available on 56" straight bench and requires the addition of a center leg.
- Table-ette is not available on modular corner units due to space limitations.

STANDARD METAL FRAME FINISH COLORS:

- 0405 Charcoal Grey
- 0535 Metallic Silver
- 0199 Chrome
- 0630 Satin Black

PREMIUM METAL FRAME FINISH COLORS:

- 0605 Matte Black
- 0705 Matte Cotton
- 0788 Glossy Cotton
- 0805 Oasis
- 0905 Mint
- 1005 Mercury
- 1105 Canary
- 1205 Stone
- 1305 Sage
- 1405 Ice Blue
- 1505 Clay

PLAYGROUND MODULAR | Designed by Chris Panichella

MINI-TAP POWER UNITS:

- Available on all models.
- Dimensions: 3" W x 3" D x 1.75" H
- Black and white color options.
- 72" electrical cord (no hardwire option or daisy chain feature available for this series).
- Placement is located under seat and may be affixed to side or front of seating unit. For side placement, unit will be centered. For front placement, please specify left, center or right, as seated.
- UL listed.

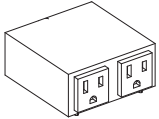

Mini-Tap 2 (MT2)

- Two outlets.

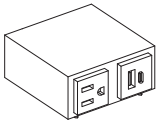

Mini-Tap 3 (MT3)

- One outlet, one USB-A and one USB-C charging port.

FABRIC APPLICATION:

- Fabric is cut "up the roll" as a standard cutting procedure (see example below). If another direction is required (i.e. "railroaded"), please specify and contact client services for yardage requirements.
- Note: Upholstery direction must be specified on corner units when patterned fabrics are selected. In the absence of specific instructions, Encore reserves the right to upholster at our discretion.

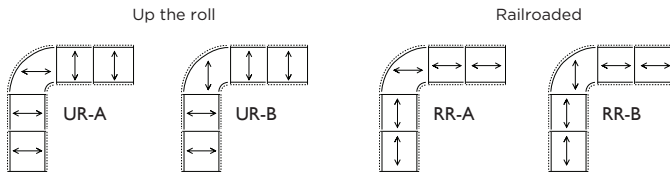

MODULAR ARRANGEMENTS:

- Optional ganging bracket available for modular bench units. Please specify "-GC07" with quantity and add \$66 List per set. One set contains two brackets for connecting two units together.
- Field assembly required.



- Note: Layout drawings or sketch is required with each modular order.

All shipments for this series will be blanket-wrapped as standard. For customers located in Territory 1 who require cartoning, a 5% upcharge will be added to each product. Please contact client services for additional information.

PLAYGROUND MODULAR | Designed by Chris Panichella

ORDERING REQUIREMENTS:

- Model number
- Frame finish
- Upholstery selection
- Options, as applicable

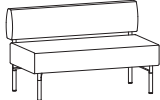
MODEL	PRODUCT SPECIFICATIONS	FABRIC GRADES								LEATHER			
		COM	A	1	2	3	4	COL 5	6	7	8	L1	L2
7224-BR 	Bench with Backrest 24" Straight 24" W x 26.75" D x 29.5 H" Seat: 24" W x 23" D Seat Ht: 17.5" COM: 1.75 yds. COL: 35 sq. ft. 42 lbs.	1,939	2,051	2,113	2,149	2,207	2,270	2,326	2,386	2,443	2,503	2,779	2,979
7248-BR 	Bench with Backrest 48" Straight 48" W x 26.75" D x 29.5 H" Seat: 48" W x 23" D Seat Ht: 17.5" COM: 3.25 yds. COL: 65 sq. ft. 67 lbs.	2,722	2,930	3,044	3,112	3,220	3,337	3,441	3,551	3,658	3,769	4,282	4,653

OPTIONS

-PF02	Premium Metal Frame Finish	\$101	-TAR02-()	Rotating Tablet, Right (as seated)	\$593
-MB01	Moisture Barrier (24" bench)	\$68	-TAL02-()	Rotating Tablet, Left (as seated)	\$593
-MB02	Moisture Barrier (48" bench)	\$89	-STR01-()	Stationary Table-ette, Right (as seated)	\$593
-NS04	Non-Skid Glides	\$26	-STL01-()	Stationary Table-ette, Left (as seated)	\$593
-GC07	Ganging Connector	\$66	-SM01	Super Matte Sable Wood Finish (tablet/table-ette)	\$12
-MT2-()	Mini-Tap Power Unit (2 power)	\$380			
-MT3-()	Mini-Tap Power Unit (1 power, 1 USB-A, 1 USB-C)	\$414			



Note: Please specify (-B) for black and (-W) for white on Mini-Tap Power Units. Please specify (-W) for wood and (-L) for laminate on Rotating Tablet and Stationary Table-ette.

All shipments for this series will be blanket-wrapped as standard. For customers located in Territory 1 who require cartoning, a 5% upcharge will be added to each product. Please contact client services for additional information.

PLAYGROUND MODULAR | Designed by Chris Panichella

ORDERING REQUIREMENTS:

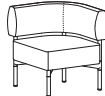
- Model number
- Frame finish
- Upholstery selection
- Options, as applicable

MODEL	PRODUCT SPECIFICATIONS	FABRIC GRADES								LEATHER			
		COM	A	1	2	3	4	COL 5	6	7	8	L1	L2
7223-BR-L 	Bench with Backrest Left End Corner Unit 26.75" W x 26.75" D x 29.5" H Seat: 23" W x 23" D Seat Ht: 17.5" COM: 2.25 yds. COL: 45 sq. ft. 45 lbs.	2,177	2,321	2,400	2,447	2,522	2,603	2,675	2,751	2,825	2,902	3,257	3,514
7223-BR-C 	Bench with Backrest Corner Unit 26.75" W x 26.75" D x 29.5" H Seat: 23" W x 23" D Seat Ht: 17.5" COM: 2.25 yds. COL: 45 sq. ft. 45 lbs.	2,177	2,321	2,400	2,447	2,522	2,603	2,675	2,751	2,825	2,902	3,257	3,514
7223-BR-R 	Bench with Backrest Right End Corner Unit 26.75" W x 26.75" D x 29.5" H Seat: 23" W x 23" D Seat Ht: 17.5" COM: 2.25 yds. COL: 45 sq. ft. 45 lbs.	2,177	2,321	2,400	2,447	2,522	2,603	2,675	2,751	2,825	2,902	3,257	3,514

OPTIONS

-PF02	Premium Metal Frame Finish	\$101
-MB01	Moisture Barrier (seat only)	\$68
-NS04	Non-Skid Glides	\$26
-GC07	Ganging Connector	\$66
-MT2(-)	Mini-Tap Power Unit (2 power)	\$380
-MT3(-)	Mini-Tap Power Unit (1 power, 1 USB-A, 1 USB-C)	\$414

Note: Please specify (-B) for black and (-W) for white on Mini-Tap Power Units.

All shipments for this series will be blanket-wrapped as standard. For customers located in Territory 1 who require cartoning, a 5% upcharge will be added to each product. Please contact client services for additional information.

PLAYGROUND MODULAR | Designed by Chris Panichella

ORDERING REQUIREMENTS:

- Model number
- Frame finish
- Upholstery selection
- Options, as applicable

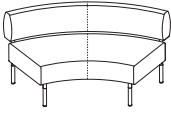
MODEL	PRODUCT SPECIFICATIONS	FABRIC GRADES										LEATHER	
		COM	A	1	2	3	4	COL 5	6	7	8	L1	L2
7260-BR	 <p>Bench with Backrest 60-Degree Inside Wedge 61.5" W x 31.25" D x 29.5 H" Seat: 57.5" W x 27.5" D Seat Ht: 17.5" COM: 4.25 yds. COL: 85 sq. ft. 72 lbs.</p>	3,256	3,528	3,677	3,766	3,907	4,060	4,196	4,340	4,480	4,625	5,296	5,781

OPTIONS

-PF02	Premium Metal Frame Finish	\$101	-TAR02-()	Rotating Tablet, Right (as seated)	\$593
-MB02	Moisture Barrier (seat only)	\$89	-TAL02-()	Rotating Tablet, Left (as seated)	\$593
-NS04	Non-Skid Glides	\$26	-STR01-()	Stationary Table-ette, Right (as seated)	\$593
-GCO7	Ganging Connector	\$66	-STL01-()	Stationary Table-ette, Left (as seated)	\$593
-MT2-()	Mini-Tap Power Unit (2 power)	\$380	-SM01	Super Matte Sable Wood Finish (tablet/table-ette)	\$12
-MT3-()	Mini-Tap Power Unit (1 power, 1 USB-A, 1 USB-C)	\$414			



Note: Please specify (-B) for black and (-W) for white on Mini-Tap Power Units. Please specify (-W) for wood and (-L) for laminate on Rotating Tablet and Stationary Table-ette.

All shipments for this series will be blanket-wrapped as standard. For customers located in Territory 1 who require cartoning, a 5% upcharge will be added to each product. Please contact client services for additional information.

PLAYGROUND MODULAR | Designed by Chris Panichella

ORDERING REQUIREMENTS:

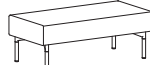
- Model number
- Leg finish
- Upholstery selection
- Options, as applicable

MODEL	PRODUCT SPECIFICATIONS	FABRIC GRADES										LEATHER	
		COM	A	1	2	3	4	COL 5	6	7	8	L1	L2
7224 	24" Straight Bench Overall: 24" W x 23" D x 17.5" H COM: 1.25 yds. COL: 25 sq. ft. 33 lbs.	1,272	1,352	1,396	1,422	1,464	1,509	1,549	1,591	1,632	1,675	1,872	2,015
7248 	48" Straight Bench Overall: 48" W x 23" D x 17.5" H COM: 1.75 yds. COL: 35 sq. ft. 56 lbs.	1,723	1,835	1,897	1,933	1,991	2,054	2,110	2,170	2,227	2,287	2,563	2,763
7256 	56" Straight Bench Overall: 56" W x 23" D x 17.5" H COM: 2.5 yds. COL: 40 sq. ft. 66 lbs.	2,020	2,180	2,268	2,320	2,403	2,493	2,573	2,658	2,740	2,825	3,220	3,505

OPTIONS

-PF02	Premium Metal Leg Finish	\$101	-TAR02-()	Rotating Tablet, Right (as seated)	\$593
-MB01	Moisture Barrier (24" bench)	\$68	-TAC01-()	Rotating Tablet, Center	\$593
-MB02	Moisture Barrier (48" & 56" bench)	\$89	-TAL02-()	Rotating Tablet, Left (as seated)	\$593
-NS04	Non-Skid Glides	\$26	-STR01-()	Stationary Table-ette, Right (as seated)	\$593
-GC07	Ganging Connector	\$66	-STC02-()	Stationary Table-ette, Center	\$593
-MT2-()	Mini-Tap Power Unit (2 power)	\$414	-STL01-()	Stationary Table-ette, Left (as seated)	\$593
-MT3-()	Mini-Tap Power Unit (1 power, 1 USB-A, 1 USB-C)	\$380	-SM01	Super Matte Sable Wood Finish (tablet/table-ette)	\$12



Note: Please specify (-B) for black and (-W) for white on Mini-Tap Power Units. Please specify (-W) for wood and (-L) for laminate on Rotating Tablet and Stationary Table-ette.

All shipments for this series will be blanket-wrapped as standard. For customers located in Territory 1 who require cartoning, a 5% upcharge will be added to each product. Please contact client services for additional information.

PLAYGROUND MODULAR | Designed by Chris Panichella

ORDERING REQUIREMENTS:

- Model number
- Leg finish
- Upholstery selection
- Options, as applicable

MODEL	PRODUCT SPECIFICATIONS	FABRIC GRADES										LEATHER	
		COM	A	1	2	3	4	COL 5	6	7	8	L1	L2
7223-L 	Left End Corner Unit Overall: 23" W x 23" D x 17.5" H COM: 1.25 yds. COL: 25 sq. ft. 36 lbs.	1,322	1,402	1,446	1,472	1,514	1,559	1,599	1,641	1,682	1,725	1,922	2,065
7223-C 	Corner Unit Overall: 23" W x 23" D x 17.5" H COM: 1.25 yds. COL: 25 sq. ft. 36 lbs.	1,322	1,402	1,446	1,472	1,514	1,559	1,599	1,641	1,682	1,725	1,922	2,065
7223-R 	Right End Corner Unit Overall: 23" W x 23" D x 17.5" H COM: 1.25 yds. COL: 25 sq. ft. 36 lbs.	1,322	1,402	1,446	1,472	1,514	1,559	1,599	1,641	1,682	1,725	1,922	2,065

OPTIONS

-PF02	Premium Metal Frame Finish	\$101
-MB02	Moisture Barrier (seat only)	\$68
-NS04	Non-Skid Glides	\$26
-GC07	Ganging Connector	\$66
-MT2(-)	Mini-Tap Power Unit (2 power)	\$380
-MT3(-)	Mini-Tap Power Unit (1 power, 1 USB-A, 1 USB-C)	\$414

Note: Please specify (-B) for black and (-W) for white on Mini-Tap Power Units.

All shipments for this series will be blanket-wrapped as standard. For customers located in Territory 1 who require cartoning, a 5% upcharge will be added to each product. Please contact client services for additional information.

PLAYGROUND MODULAR | Designed by Chris Panichella

ORDERING REQUIREMENTS:

- Model number
- Leg finish
- Upholstery selection
- Options, as applicable

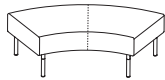
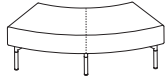
MODEL	PRODUCT SPECIFICATIONS	FABRIC GRADES										LEATHER	
		COM	A	1	2	3	4	COL 5	6	7	8	L1	L2
7260 	60-Degree Inside Wedge Bench Overall: 57.75" W x 27.5" D x 17.5" H COM: 2.25 yds. COL: 45 sq. ft. 48 lbs.	2,161	2,305	2,384	2,431	2,506	2,587	2,659	2,735	2,809	2,886	3,241	3,498
7261 	60-Degree Outside Wedge Bench Overall: 57.75" W x 27.5" D x 17.5" H COM: 2.25 yds. COL: 45 sq. ft. 48 lbs.	2,161	2,305	2,384	2,431	2,506	2,587	2,659	2,735	2,809	2,886	3,241	3,498

OPTIONS

-PF02	Premium Metal Leg Finish	\$101	-TAR02-()	Rotating Tablet, Right (as seated)	\$593
-MB02	Moisture Barrier	\$89	-TAL02-()	Rotating Tablet, Left (as seated)	\$593
-NS04	Non-Skid Glides	\$26	-STR01-()	Stationary Table-ette, Right (as seated)	\$593
-GC07	Ganging Connector	\$66	-STL01-()	Stationary Table-ette, Left (as seated)	\$593
-MT2-()	Mini-Tap Power Unit (2 power)	\$414	-SM01	Super Matte Sable Wood Finish (tablet/table-ette)	\$12
-MT3-()	Mini-Tap Power Unit (1 power, 1 USB-A, 1 USB-C)	\$380			

Note: Please specify (-B) for black and (-W) for white on Mini-Tap Power Units. Please specify (-W) for wood and (-L) for laminate on Rotating Tablet and Stationary Table-ette.

All shipments for this series will be blanket-wrapped as standard. For customers located in Territory 1 who require cartoning, a 5% upcharge will be added to each product. Please contact client services for additional information.

PLAYGROUND MODULAR - CONFIGURATION & ORDERING EXAMPLES

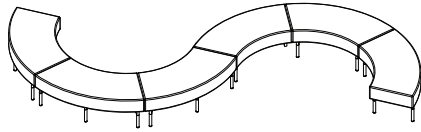

<u>Qty.</u>	<u>Model #</u>	<u>Description</u>	<u>COM List</u>
6	7260	60-Degree Inside Wedge Bench (\$2,161 List each)	\$12,966

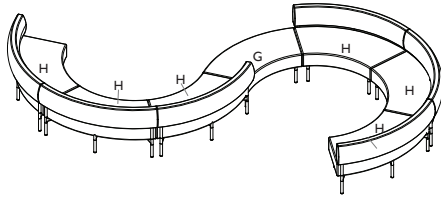

<u>Qty.</u>	<u>Model #</u>	<u>Description</u>	<u>COM List</u>	<u>Key</u>
6	7260-BR	Bench with Backrest, 60-Degree Inside Wedge (\$3,256 List each)	\$19,536	H
1	7260	60-Degree Inside Wedge Bench	<u>\$2,161</u>	G
			\$21,697	

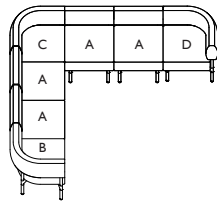

<u>Qty.</u>	<u>Model #</u>	<u>Description</u>	<u>COM List</u>	<u>Key</u>
4	7224-BR	Bench with Backrest, 24" Straight (\$1,939 List each)	\$7,756	A
1	7223-BR-L	Bench with Backrest, Left End Corner Unit	\$2,177	B
1	7223-BR-C	Bench with Backrest, Corner Unit	\$2,177	C
1	7223-BR-R	Bench with Backrest, Right End Corner Unit	<u>\$2,177</u>	D
			\$14,287	

PLAYGROUND MODULAR | Designed by Chris Panichella

UPHOLSTERY COMBINATIONS:

- For upholstery combinations, refer to the pricing below.
- When combining two COM/COV/COL fabrics, or fabrics with the same grade, add \$120 List per unit.
- When combining three or more COM/COV/COL fabrics, or fabrics with the same grade, add \$150 List per unit.
- When combining different grades of fabric, price will be based on the highest grade specified.
- Two-tone upholstery examples and yardage requirements for the most common combinations are listed below. Additional combinations available; please contact client services for yardage requirements and pricing.
- Note: Yardage amounts are based on fabric which is plain (i.e. non-directional) and a full 54" wide.
- Appropriate upholstery code must be included.

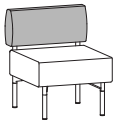

Code PL1
Model COM Requirement
 7224-BR Backrest Only = 1 yd.
 Balance of Bench = 1.75 yds.

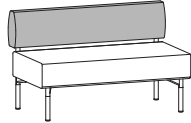

Code PL2
Model COM Requirement
 7248-BR Backrest Only = 2 yds.
 Balance of Bench = 2 yds.

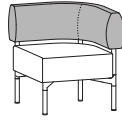

Code PL3
Model COM Requirement
 7223-BR-C Backrest Only = 1.25 yds.
 7223-BR-L Balance of Bench = 1.25 yds.
 7223-BR-R

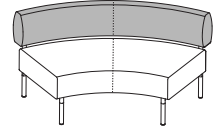

Code PL5
Model COM Requirement
 7260-BR Backrest Only = 2 yds.
 Balance of Bench = 2.25 yds.

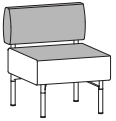

Code PL10
Model COM Requirement
 7224-BR Backrest & Top of Seat = 2.5 yds.
 Balance of Bench = .75 yd.

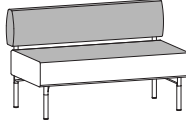

Code PL11
Model COM Requirement
 7248-BR Backrest & Top of Seat = 3.5 yds.
 Balance of Bench = .75 yd.

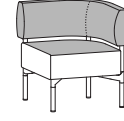

Code PL12
Model COM Requirement
 7223-BR-C Backrest & Top of Seat = 1.75 yds.
 7223-BR-L Balance of Bench = .75 yd.
 7223-BR-R

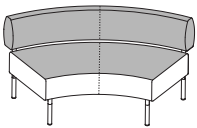

Code PL14
Model COM Requirement
 7260-BR Backrest & Top of Seat = 3 yds.
 Balance of Bench = 1.75 yds.



Code PL19
Model COM Requirement
 7224 Top of Seat = 1.5 yds.
 Balance of Bench = .75 yd.

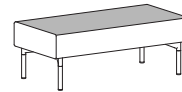

Code PL20
Model COM Requirement
 7248 Top of Seat = 1.5 yds.
 Balance of Bench = .75 yd.

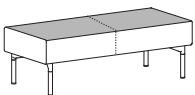

Code PL21
Model COM Requirement
 7256 Top of Seat = 2 yds.
 Balance of Bench = .75 yd.

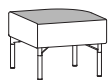

Code PL22
Model COM Requirement
 7223-C Top of Seat = 1.5 yds.
 7223-L Balance of Bench = .75 yd.
 7223-R

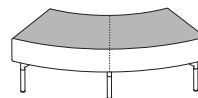

Code PL23
Model COM Requirement
 7260 Top of Seat = 1.75 yds.
 7261 Balance of Bench = 1.75 yds.

All shipments for this series will be blanket-wrapped as standard. For customers located in Territory 1 who require cartoning, a 5% upcharge will be added to each product. Please contact client services for additional information.

POPOVER POUFS | Designed by Chris & Jon Panichella



SPECIFICATIONS:

- Square poufs available in two sizes: 20" and 24".
- Leather pull/strap offered in four standard colors. Please refer to listing below.
- Pull/strap also available in COL (Customer's Own Leather).
- Each unit comes standard with glides.
- Optional felt glides for hard surface flooring.
- 300 lb. weight capacity.
- All dimensions are nominal.
- Refer to terms and conditions for general information regarding fabrics, finishes, warranty, freight, complete condition of sales and more.

STANDARD LEATHER PULL/STRAP COLORS:

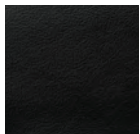

Black

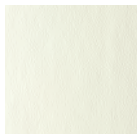

Bright White

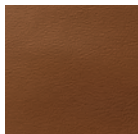

Saddle

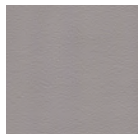

Fog

All shipments for this series will be blanket-wrapped as standard. For customers located in Territory 1 who require cartoning, a 5% upcharge will be added to each product. Please contact client services for additional information.

POPOVER POUFS | Designed by Chris & Jon Panichella

ORDERING REQUIREMENTS:

- Model number
- Pull/strap color
- Upholstery selection
- Options, as applicable

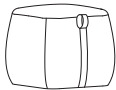
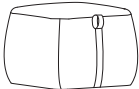
MODEL	PRODUCT SPECIFICATIONS	FABRIC GRADES								LEATHER			
		COM	A	1	2	3	4	COL 5	6	7	8	L1	L2
3820	 <p>20" Square Pouf 20" W x 20" D x 17.5" H COM: 2 yds. COL: 40 sq. ft. 22 lbs.</p>	993	1,121	1,191	1,233	1,299	1,371	1,435	1,503	1,569	1,637	1,953	2,181
3824	 <p>24" Square Pouf 24" W x 24" D x 17.5" H COM: 2 yds. COL: 40 sq. ft. 28 lbs.</p>	1,154	1,282	1,352	1,394	1,460	1,532	1,596	1,664	1,730	1,798	2,114	2,342

OPTIONS

- P02 COL Pull/Strap \$152
(requires 3" x 30" per unit)
- FG04 Felt Glides \$26

 = Available on quick-ship program.

POPOVER POUFS | Designed by Chris & Jon Panichella

UPHOLSTERY COMBINATIONS:

- For upholstery combinations, refer to the pricing below.
- When combining two COM/COV/COL fabrics, or fabrics with the same grade, add \$120 List per unit.
- When combining three or more COM/COV/COL fabrics, or fabrics with the same grade, add \$150 List per unit.
- When combining different grades of fabric, price will be based on the highest grade specified.
- Two-tone upholstery examples and yardage requirements for the most common combinations are listed below. Additional combinations available; please contact client services for yardage requirements and pricing.
- Note: Yardage amounts are based on fabric which is plain (i.e. non-directional) and a full 54" wide.
- Appropriate upholstery code must be included.

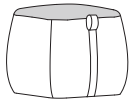

Code PV1

<u>Model</u>	<u>COM Requirement</u>
All Models	Top of Seat = .75 yd. Side Panels = 1.25 yds.

All shipments for this series will be blanket-wrapped as standard. For customers located in Territory 1 who require cartoning, a 5% upcharge will be added to each product. Please contact client services for additional information.

RECESS® GUEST



SPECIFICATIONS:

- Arm and armless options.
- Arm model features black polypropylene arm cap.
- Frame available in standard and premium finishes. See below for options.
- For custom metal finish colors, please contact client services for pricing.
- Stacks 6-high from floor.
- If cartoning is required, chairs are packaged in units of three (3). A \$20 List carton break charge will be applied for orders with only one or two chairs.
- 300 lb. weight capacity.
- All dimensions are nominal.
- Refer to terms and conditions for general information regarding fabrics, finishes, warranty, freight, complete condition of sales and more.

STANDARD METAL FRAME FINISH COLORS:

- 0405 Charcoal Grey
- 0535 Metallic Silver

PREMIUM METAL FRAME FINISH COLORS:



- 0605 Matte Black
- 0705 Matte Cotton
- 0788 Glossy Cotton
- 0805 Oasis
- 0905 Mint
- 1005 Mercury
- 1105 Canary
- 1205 Stone
- 1305 Sage
- 1405 Ice Blue
- 1505 Clay

All shipments for this series will be blanket-wrapped as standard. For customers located in Territory 1 who require cartoning, a 5% upcharge will be added to each product. Please contact client services for additional information.

RECESS® GUEST

ORDERING REQUIREMENTS:

- Model number
- Frame finish
- Upholstery selection
- Options, as applicable

MODEL	PRODUCT SPECIFICATIONS	FABRIC GRADES								LEATHER			
		COM	A	1	2	3	4	COL 5	6	7	8	L1	L2
2210 	Fully Upholstered, Arms 22" W x 25" D x 33" H Seat: 19.5" W x 20" D Seat Ht: 18" Arm Ht: 25.75" COM: 1.5 yds. COL: 30 sq. ft. 25 lbs.	637	733	786	817	867	921	969	1,020	1,069	1,120	1,357	1,528
2230 	Fully Upholstered, Armless 21" W x 25" D x 33" H Seat: 19.5" W x 20" D Seat Ht: 18" COM: 1.5 yds. COL: 30 sq. ft. 23 lbs.	626	722	775	806	856	910	958	1,009	1,058	1,109	1,346	1,517

OPTIONS

-PF02	Premium Metal Frame Finish	\$101
-EF01	1" Additional Seat Foam	\$44
-GC08	Ganging Bracket	\$42
-VCT04	VCT Tile Glides	\$28

All shipments for this series will be cartoned as standard. If blanket-wrapped shipping is required, please contact client services for additional information.

ROMP OCCASIONAL TABLES | Designed by Gower + Woolf



SPECIFICATIONS:

- Metal frame with inset table-top.
- Frame is comprised of 14-gauge steel tray and ½" solid metal rod legs.
- Four top surface options: wood veneer, laminate, Fenix and solid surface.
- Wood veneer available in all standard and custom finishes on Ash.
- For custom wood finishes, please contact client services and add one-time upcharge of \$531 List per color per order.
- For Super Matte Sable Ash finish, upcharge applies. Refer to option section for pricing.
- For custom laminate options, add \$649 List per color per order. Pre-approval required, please contact client services.
- Fenix offered in five standard colorways.
- For non-standard Fenix colors, please contact client services for pricing.
- Solid surface available in white only.
- Metal frame offered in standard and premium metal finishes (chrome not available). Please refer to listing below.
- Legs ship separately (assembly required).
- All dimensions are nominal.
- Refer to terms and conditions for general information regarding finishes, warranty, freight, complete condition of sales and more.

FENIX COLORS:

- Bianco Kos
- Nero Ingo
- Grigio Efeso
- Grigio Londra
- Grigio Bromo

STANDARD METAL FRAME FINISH COLORS:

- 0405 Charcoal Grey
- 0535 Metallic Silver
- 0630 Satin Black

PREMIUM METAL FRAME FINISH COLORS:



- 0605 Matte Black
- 0705 Matte Cotton
- 0788 Glossy Cotton
- 0805 Oasis
- 0905 Mint
- 1005 Mercury
- 1105 Canary
- 1205 Stone
- 1305 Sage
- 1405 Ice Blue
- 1505 Clay

All shipments for this series will be cartoned as standard. If blanket-wrapped shipping is required, please contact client services for additional information.

ROMP OCCASIONAL TABLES | Designed by Gower + Woolf

ORDERING REQUIREMENTS:

- Model number
- Top surface
- Top finish, as applicable
- Frame finish
- Options, as applicable

MODEL	DIMENSIONS	veneer TOP (-V)	LAMINATE TOP (-L)	FENIX TOP (-FE)	SOLID SURFACE TOP (-SF)	WEIGHT
 16" Height 2000-2116-() 2000-3016-() 2000-3616-()	21" Dia. x 16" H	1,416	1,286	1,421	1,521	19 lbs.
	30" Dia. x 16" H	1,876	1,703	1,977	2,182	30 lbs.
	36" Dia. x 16" H	2,316	2,037	2,432	2,970	35 lbs.
 18" Height 2000-2118-() 2000-3018-() 2000-3618-()	21" Dia. x 18" H	1,431	1,301	1,436	1,536	22 lbs.
	30" Dia. x 18" H	1,891	1,718	1,992	2,197	33 lbs.
	36" Dia. x 18" H	2,330	2,052	2,447	2,985	38 lbs.

OPTIONS

- PF02 Premium Metal Frame Finish \$101
- SM02 Super Matte Sable Wood Finish \$23

 = Available on quick-ship program (all tops with standard base finishes only).

SIGNAL® GUEST | Licensed from Wiesner Hager - Austria



SPECIFICATIONS:

- Fully upholstered and wood back models.
- Arm and armless options.
- Wood back offered in all standard finishes on Beech.
- For Super Matte Sable Beech finish, upcharge applies. Refer to option section for pricing.
- For custom wood finishes, please add \$531 List per color per order.
- 1" square steel frame.
- Frame available in standard and premium finishes. Please refer to listing below.
- Chairs stack up to 5 high standing.
- Fully upholstered cantilever frame model with horizontal stitching detail also available.
- Cantilever model features 1.25" wide x .75" thick rectangular steel frame and black leather soft-touch arm caps.
- Optional felt glides for hard surface flooring (cantilever model only).
- 350 lb. weight capacity.
- All dimensions are nominal.
- Refer to terms and conditions for general information regarding fabrics, finishes, warranty, freight, complete condition of sales and more

STANDARD METAL FRAME FINISH COLORS:

- 0405 Charcoal Grey
- 0535 Metallic Silver
- 0199 Chrome (not available on armless models)
- 0630 Satin Black

PREMIUM METAL FRAME FINISH COLORS:



- 0605 Matte Black
- 0705 Matte Cotton
- 0788 Glossy Cotton
- 0805 Oasis
- 0905 Mint
- 1005 Mercury
- 1105 Canary
- 1205 Stone
- 1305 Sage
- 1405 Ice Blue
- 1505 Clay

All shipments for this series will be blanket-wrapped as standard. For customers located in Territory 1 who require cartoning, a 5% upcharge will be added to each product. Please contact client services for additional information.

SIGNAL® GUEST | Licensed from Wiesner Hager - Austria

ORDERING REQUIREMENTS:

- Model number
- Frame finish
- Upholstery selection
- Options, as applicable

MODEL	PRODUCT SPECIFICATIONS	FABRIC GRADES								LEATHER			
		COM	A	1	2	3	4	COL 5	6	7	8	L1	L2
3510-P 	Guest Chair, Fully Upholstered, Polypropylene Arms 22.75" W x 21" D x 31.75" H Seat: 18" W x 16.5" D Seat Ht: 18.5" Arm Ht: 25.5" COM: 1.25 yds. COL: 25 sq. ft. 20 lbs.	1,015	1,095	1,139	1,165	1,207	1,252	1,292	1,334	1,375	1,418	1,615	1,758
3530 	Guest Chair, Fully Upholstered, Armless* 19.75" W x 21" D x 31.75" H Seat: 18" W x 16.5" D Seat Ht: 18.5" COM: 1.25 yds. COL: 25 sq. ft. 19 lbs.	840	920	964	990	1,032	1,077	1,117	1,159	1,200	1,243	1,440	1,583

* Please note that 0199 Chrome frame finish is not available on armless models.

OPTIONS



- PF02 Premium Metal Frame Finish \$101
- GC09 Ganging Connector \$56

All shipments for this series will be blanket-wrapped as standard. For customers located in Territory 1 who require cartoning, a 5% upcharge will be added to each product. Please contact client services for additional information.

SIGNAL® GUEST | Licensed from Wiesner Hager - Austria

ORDERING REQUIREMENTS:

- Model number
- Wood finish
- Frame finish
- Upholstery selection
- Options, as applicable

MODEL	PRODUCT SPECIFICATIONS	FABRIC GRADES										LEATHER	
		COM	A	1	2	3	4	COL 5	6	7	8	L1	L2
3511-P 	Guest Chair, Wood Back, Polypropylene Arms 22.75" W x 23.25" D x 31.75" H Seat: 18" W x 18" D Seat Ht: 18.5" Arm Ht: 25.5" COM: .75 yd. COL: 15 sq. ft. 19 lbs.	1,115	1,163	1,190	1,205	1,230	1,257	1,281	1,307	1,331	1,357	1,475	1,561
3531 	Guest Chair, Wood Back, Armless* 19.75" W x 23.25" D x 31.75" H Seat: 18" W x 18" D Seat Ht: 18.5" COM: .75 yd. COL: 15 sq. ft. 18 lbs.	973	1,021	1,048	1,063	1,088	1,115	1,139	1,165	1,189	1,215	1,333	1,419

* Please note that 0199 Chrome frame finish is not available on armless models.

OPTIONS

-PF02	Premium Metal Frame Finish	\$101
-SM02	Super Matte Sable Wood Finish (wood back)	\$23
-GC09	Ganging Connector	\$56

All shipments for this series will be blanket-wrapped as standard. For customers located in Territory 1 who require cartoning, a 5% upcharge will be added to each product. Please contact client services for additional information.

SIGNAL® GUEST | Licensed from Wiesner Hager - Austria

ORDERING REQUIREMENTS:

- Model number
- Frame finish
- Upholstery selection
- Options, as applicable

MODEL	PRODUCT SPECIFICATIONS	FABRIC GRADES										LEATHER	
		COM	A	1	2	3	4	COL 5	6	7	8	L1	L2
3520 	Guest Chair, Arms Cantilever Frame 22" W x 23" D x 35" H Seat: 19.5" W x 18.75" D Seat Ht: 18" Arm Ht: 26" COM: 2 yds. COL: 40 sq. ft. 28 lbs.	1,506	1,634	1,704	1,746	1,812	1,884	1,948	2,016	2,082	2,150	2,466	2,694

OPTIONS

- PF02 Premium Metal Frame Finish \$101
- FG04 Felt Glides \$26

All shipments for this series will be blanket-wrapped as standard. For customers located in Territory 1 who require cartoning, a 5% upcharge will be added to each product. Please contact client services for additional information.

SKYLINE MEETING TABLES



SPECIFICATIONS:

- Round and square top shapes available in laminate and solid surface.
- 29" and 42" table heights. Custom heights between 29" and 42" available. Please specify and add \$165 List per unit. Price is based on the higher standard table height (e.g. 32" custom height, price is based on the 42" standard height plus \$165).
- Laminate available in all standard colors.
- For custom laminate options, add \$649 List per color per order. Pre-approval required, please contact client services.
- For standard wood grain laminate or solid black laminate tops, edge will match unless specified otherwise.
- For all other solid laminates, edge will be exposed plywood substrate with clear coat finish.
- Solid surface available in white only.
- Solid surface tops feature exposed plywood substrate edge with clear coat finish.
- Laminate tops are $\frac{3}{4}$ " thick and solid surface tops are 1" thick.
- Metal column and base plate available in standard and premium finishes. Please refer to listing below.
- For custom metal finish colors, please contact client services for pricing.
- All dimensions are nominal.
- Refer to terms and conditions for general information regarding finishes, warranty, freight, complete condition of sales and more.

EDGE DETAIL:

Laminate* Top



Solid Surface Top



*Please note that laminate thickness is nominal and may vary.

SQUARE TOP SHAPE:

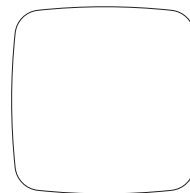

STANDARD METAL BASE FINISH COLORS:

- 0405 Charcoal Grey
- 0535 Metallic Silver
- 0199 Chrome
- 0630 Satin Black

PREMIUM METAL BASE FINISH COLORS:



- 0605 Matte Black
- 0705 Matte Cotton
- 0788 Glossy Cotton
- 0805 Oasis
- 0905 Mint
- 1005 Mercury
- 1105 Canary
- 1205 Stone
- 1305 Sage
- 1405 Ice Blue
- 1505 Clay

All shipments for this series will be blanket-wrapped as standard. For customers located in Territory 1 who require cartoning, a 5% upcharge will be added to each product. Please contact client services for additional information.

SKYLINE MEETING TABLES

ORDERING REQUIREMENTS:

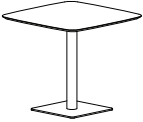
- Model number
- Top surface
- Top finish, as applicable
- Column/base plate finish
- Options, as applicable

MODEL	LAMINATE TOP (-L)	SOLID SURFACE TOP (-SF)	COLUMN DIAMETER	BASE PLATE DIMENSIONS	WEIGHT	
 <p>Square Top, 29" Height</p>	7100-323229-()	2,010	2,749	3"	18" Square	68 lbs.
	7100-363629-()	2,257	3,190	3"	22" Square	76 lbs.
	7100-424229-()	2,554	3,822	3"	22" Square	85 lbs.
	7100-484829-()	2,987	4,641	4"	22" Square	91 lbs.
 <p>Square Top, 42" Height</p>	7100-323242-()	2,083	2,822	3"	18" Square	74 lbs.
	7100-363642-()	2,332	3,265	3"	22" Square	82 lbs.

OPTIONS

-PF02 Premium Metal Base Finish \$101

All shipments for this series will be blanket-wrapped as standard. For customers located in Territory 1 who require cartoning, a 5% upcharge will be added to each product. Please contact client services for additional information.

SKYLINE MEETING TABLES

ORDERING REQUIREMENTS:

- Model number
- Top surface
- Top finish, as applicable
- Column/base plate finish
- Options, as applicable

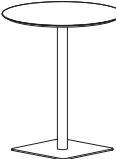
MODEL	LAMINATE TOP (-L)	SOLID SURFACE TOP (-SF)	COLUMN DIAMETER	BASE PLATE DIMENSIONS	WEIGHT
 <p>Round Top, 29" Height</p> <p>7101-2929-()</p> <p>7101-3629-()</p> <p>7101-4229-()</p> <p>7101-4829-()</p>	2,051	2,530	3"	18" Square	68 lbs.
	2,465	3,398	3"	22" Square	76 lbs.
	2,542	3,810	3"	22" Square	85 lbs.
	2,621	4,275	4"	22" Square	91 lbs.
 <p>Round Top, 42" Height</p> <p>7101-2942-()</p> <p>7101-3642-()</p>	2,125	2,604	3"	18" Square	74 lbs.
	2,539	3,472	3"	22" Square	82 lbs.

OPTIONS

-PF02 Premium Metal Base Finish \$101

All shipments for this series will be blanket-wrapped as standard. For customers located in Territory 1 who require cartoning, a 5% upcharge will be added to each product. Please contact client services for additional information.

SKYLINE OCCASIONAL TABLES



SPECIFICATIONS:

- Round and square top shapes available in laminate and solid surface.
- 16" and 18" table heights.
- Laminate available in all standard colors.
- For custom laminate options, add \$649 List per color per order. Pre-approval required, please contact client services.
- For standard wood grain laminate or solid black laminate tops, edge will match unless specified otherwise.
- For all other solid laminates, edge will be exposed plywood substrate with clear coat finish.
- Solid surface available in white only.
- Solid surface tops feature exposed plywood substrate edge with clear coat finish.
- Laminate tops are 3/4" thick and solid surface tops are 1" thick.
- Metal column and base plate available in standard and premium finishes. Please refer to listing below.
- For custom metal finish colors, please contact client services for pricing.
- All dimensions are nominal.
- Refer to terms and conditions for general information regarding finishes, warranty, freight, complete condition of sales and more.

EDGE DETAIL:

Laminate* Top



Solid Surface Top

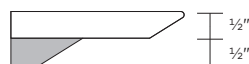

*Please note that laminate thickness is nominal and may vary.

SQUARE TOP SHAPE:

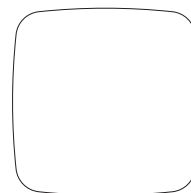

STANDARD METAL BASE FINISH COLORS:

- 0405 Charcoal Grey
- 0535 Metallic Silver
- 0199 Chrome
- 0630 Satin Black

PREMIUM METAL BASE FINISH COLORS:

- 0605 Matte Black
- 0705 Matte Cotton
- 0788 Glossy Cotton
- 0805 Oasis
- 0905 Mint
- 1005 Mercury
- 1105 Canary
- 1205 Stone
- 1305 Sage
- 1405 Ice Blue
- 1505 Clay

All shipments for this series will be blanket-wrapped as standard. For customers located in Territory 1 who require cartoning, a 5% upcharge will be added to each product. Please contact client services for additional information.

SKYLINE OCCASIONAL TABLES

ORDERING REQUIREMENTS:

- Model number
- Top surface
- Top finish, as applicable
- Column/base plate finish
- Options, as applicable

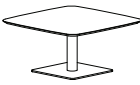
MODEL	LAMINATE TOP (-L)	SOLID SURFACE TOP (-SF)	COLUMN DIAMETER	BASE PLATE DIMENSIONS	WEIGHT	
 <p>Square Top, 16" Height</p>	7100-181816-()	1,110	1,284	3"	14" Square	19 lbs.
	7100-222216-()	1,330	1,636	3"	14" Square	30 lbs.
	7100-323216-()	1,833	2,572	3"	18" Square	52 lbs.
	7100-363616-()	2,080	3,013	3"	22" Square	58 lbs.
	7100-424216-()	2,378	3,646	3"	22" Square	66 lbs.
	7100-484816-()	2,810	4,464	3"	22" Square	72 lbs.
 <p>Square Top, 18" Height</p>	7100-484818-()	2,863	4,517	4"	22" Square	75 lbs.
 <p>Round Top, 16" Height</p>	7101-1916-()	1,184	1,376	3"	14" Square	19 lbs.
	7101-2116-()	1,254	1,489	3"	14" Square	30 lbs.
	7101-2916-()	1,875	2,354	3"	18" Square	52 lbs.
	7101-3616-()	2,289	3,222	3"	22" Square	58 lbs.
	7101-4216-()	2,368	3,636	3"	22" Square	66 lbs.
	7101-4816-()	2,446	4,100	3"	22" Square	72 lbs.
 <p>Round Top, 18" Height</p>	7101-4818-()	2,499	4,153	4"	22" Square	75 lbs.

OPTIONS

-PF02 Premium Metal Base Finish \$101

All shipments for this series will be blanket-wrapped as standard. For customers located in Territory 1 who require cartoning, a 5% upcharge will be added to each product. Please contact client services for additional information.

STRING GAMES MEETING TABLES | Designed by Madsen & Contois



SPECIFICATIONS:

- Available in two heights: 29" and 42".
- Depth options include: 24", 30" and 36".
- Length sizes include: 60", 72", 84" and 96".
- Tables offered in wood veneer, laminate and solid surface.
- Solid surface available in white only.
- To order a non-standard solid surface color, please specify the manufacturer, pattern name and color number. Please contact client services to confirm pricing.
- **Interior and exterior metal accents are featured as standard.**
- Also offered without interior and exterior metal accents, in various combinations, at no charge. Please refer to specific pages for options.
- Metal accents available in standard and premium finishes. See following page for options.
- For custom metal finish colors, please contact client services for pricing.
- Tables feature black reveal between top edge of panels and table-top.
- When specifying white laminate or solid surface, reveal will be white.
- For tables intended to be placed end-to-end, please select applicable option code without exterior metal accents (-MA0) or with exterior metal accent on single side only (-MA3).
- Panel bases and underside of tables feature removable panels for wire management accessibility.
- All panel bases feature adjustable glides as standard for leveling purposes.
- Ships KD. Assembly required.
- To ship fully assembled, set-up charge will be \$500 List per unit
- Please note that Canadian shipments are unable to be shipped blanket-wrapped and a 20% cartoning surcharge will always apply.
- Optional power units available. Please refer to pages 5-8 for options.
- All dimensions are nominal.
- Refer to terms and conditions for general information regarding finishes, warranty, freight, complete condition of sales and more.

VENEER TABLE FEATURES:

- Three wood species available: Ash, Maple and Walnut.
- For Super Matte Sable finish on Ash or Maple, upcharge applies. Refer to option section for pricing.
- For custom wood finishes, please contact client services and add one-time upcharge of \$531 List per color per order.
- Due to natural variations of grain and color in woods, slight variations may occur.
- Veneer direction will run lengthwise on all table sizes.
- Edge finish will match top finish unless specified otherwise.

STRING GAMES MEETING TABLES | Designed by Madsen & Contois

LAMINATE TABLE FEATURES:

- Laminate available in all standard colors.
- If white laminate is desired for top and panel bases, it is recommended to utilize Formica 949-58 White Matte with a ColorCore® 2 edge detail in matching 949C-58 White Matte to eliminate the black line that occurs with traditional laminates. Please specify and add \$354 List to the laminate pricing column.
- For custom laminate options, add \$649 List per color per order. Pre-approval required, please contact client services.
- Laminate wood grain direction will run lengthwise on all table sizes.
- Self edge standard, unless otherwise specified (laminate applied to edge).

SOLID SURFACE TABLE FEATURES:

- Solid surface is affixed to table top only (not available on table edges or panel bases). Please note that a 1/8" reveal will be present.
- Solid surface available in white only.
- To order a non-standard solid surface color, please specify the manufacturer, pattern name and color number. Contact client services to confirm pricing.
- Please specify wood or laminate finish for the table interior surface and panel bases, which will also be applied to the edge.

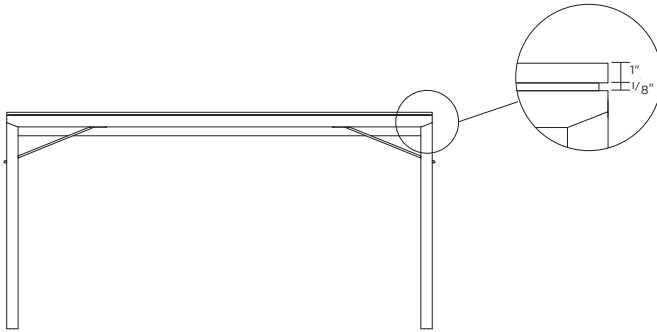

STANDARD METAL ACCENT FINISH COLORS:

- 0405 Charcoal Grey
- 0535 Metallic Silver
- 0199 Chrome
- 0630 Satin Black

PREMIUM METAL ACCENT FINISH COLORS:

- 0605 Matte Black
- 0705 Matte Cotton
- 0788 Glossy Cotton
- 0805 Oasis
- 0905 Mint
- 1005 Mercury
- 1105 Canary
- 1205 Stone
- 1305 Sage
- 1405 Ice Blue
- 1505 Clay

All shipments for this series will be blanket-wrapped as standard. For customers located in Territory 1 who require cartoning, a 5% upcharge will be added to each product. Please contact client services for additional information.

STRING GAMES MEETING TABLES | Designed by Madsen & Contois

ORDERING REQUIREMENTS:

- Model number
- Surface material
- Surface finish
- Metal accent finish
- Options, as applicable

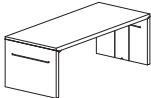
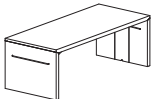
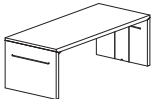
MODEL	DIMENSIONS	LAMINATE	MAPLE VENEER	ASH OR WALNUT VENEER	SOLID SURFACE <small>Add upcharge to applicable wood species column</small>	WEIGHT <small>For veneer, laminate and ColorCore 2 tables only</small>	
 Interior/Exterior Metal Accents 24" Depth, 29" Height	8122-246029	24" D x 60" L x 29" H	5,293	5,453	6,407	1,036	149 lbs.
	8122-247229	24" D x 72" L x 29" H	5,738	5,911	7,023	1,241	165 lbs.
	8122-248429	24" D x 84" L x 29" H	6,044	6,225	7,333	1,448	172 lbs.
	8122-249629	24" D x 96" L x 29" H	6,313	6,503	7,612	1,654	179 lbs.
 Interior/Exterior Metal Accents 30" Depth, 29" Height	8122-306029	30" D x 60" L x 29" H	5,956	6,134	7,405	1,294	160 lbs.
	8122-307229	30" D x 72" L x 29" H	6,235	6,422	7,683	1,553	176 lbs.
	8122-308429	30" D x 84" L x 29" H	6,552	6,749	8,010	1,810	182 lbs.
	8122-309629	30" D x 96" L x 29" H	6,863	7,069	8,326	2,067	190 lbs.
 Interior/Exterior Metal Accents 36" Depth, 29" Height	8122-366029	36" D x 60" L x 29" H	5,882	6,060	7,002	1,553	171 lbs.
	8122-367229	36" D x 72" L x 29" H	6,413	6,607	7,704	1,861	187 lbs.
	8122-368429	36" D x 84" L x 29" H	6,773	6,977	8,072	2,170	193 lbs.
	8122-369629	36" D x 96" L x 29" H	7,089	7,303	8,388	2,480	202 lbs.

OPTIONS

-PF02	Premium Metal Finish	\$101
-SM06	Super Matte Sable Wood Finish	\$311
-MA0	No Metal Accents	n/c
-MA2	Interior Metal Accents Only	n/c
-MA3	Interior Metal Accents - Both Sides Exterior Metal Accent - Single Side	n/c

MA0



No Metal Accents

MA2



Interior Metal Accents Only

MA3



Interior Metal Accents - Both Sides
Exterior Metal Accents - Single Side

All shipments for this series will be blanket-wrapped as standard. For customers located in Territory 1 who require cartoning, a 5% upcharge will be added to each product. Please contact client services for additional information.

STRING GAMES MEETING TABLES | Designed by Madsen & Contois

ORDERING REQUIREMENTS:

- Model number
- Surface material
- Surface finish
- Metal accent finish
- Options, as applicable

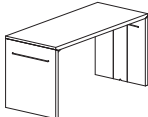
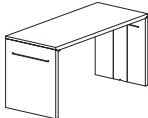
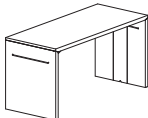
MODEL	DIMENSIONS	LAMINATE	MAPLE VENEER	ASH OR WALNUT VENEER	SOLID SURFACE <small>Add upcharge to applicable wood species column</small>	WEIGHT <small>For veneer, laminate and ColorCore 2 tables only</small>	
 Interior/Exterior Metal Accents 24" Depth, 42" Height	8122-246042	24" D x 60" L x 42" H	6,107	6,291	7,562	1,036	157 lbs.
	8122-247242	24" D x 72" L x 42" H	6,376	6,568	7,841	1,241	173 lbs.
	8122-248442	24" D x 84" L x 42" H	6,659	6,860	8,123	1,448	180 lbs.
	8122-249642	24" D x 96" L x 42" H	6,928	7,136	8,400	1,654	189 lbs.
 Interior/Exterior Metal Accents 30" Depth, 42" Height	8122-306042	30" D x 60" L x 42" H	7,083	7,296	9,197	1,294	168 lbs.
	8122-307242	30" D x 72" L x 42" H	7,402	7,624	9,522	1,553	184 lbs.
	8122-308442	30" D x 84" L x 42" H	7,720	7,952	9,849	1,810	190 lbs.
	8122-309642	30" D x 96" L x 42" H	7,998	8,238	10,126	2,067	199 lbs.
 Interior/Exterior Metal Accents 36" Depth, 42" Height	8122-366042	36" D x 60" L x 42" H	7,900	8,137	10,513	1,553	179 lbs.
	8122-367242	36" D x 72" L x 42" H	8,224	8,471	10,836	1,861	195 lbs.
	8122-368442	36" D x 84" L x 42" H	8,592	8,849	11,213	2,170	201 lbs.
	8122-369642	36" D x 96" L x 42" H	8,946	9,215	11,578	2,480	211 lbs.

OPTIONS

-PF02	Premium Metal Finish	\$101
-SM06	Super Matte Sable Wood Finish	\$311
-MA0	No Metal Accents	n/c
-MA2	Interior Metal Accents Only	n/c
-MA3	Interior Metal Accents - Both Sides Exterior Metal Accent - Single Side	n/c

MA0



No Metal Accents

MA2



Interior Metal Accents Only

MA3



Interior Metal Accents - Both Sides
Exterior Metal Accents - Single Side

All shipments for this series will be blanket-wrapped as standard. For customers located in Territory 1 who require cartoning, a 5% upcharge will be added to each product. Please contact client services for additional information.

STRING GAMES MEETING TABLES - POWER UNITS | Designed by Madsen & Contois

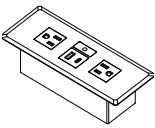

- Unit below is corded and available for top surface and/or side-mount placement. Refer to pages 6-7 for daisy chain options.
- Side-mount placement available on outside of panel bases and can only be added to tables without exterior metal accent. Power unit will be positioned vertically and includes matching wood cover on panel base interior.
- Please specify if power unit is to be placed on table top or outside base panel.
- Cord length should be taken into account when specifying electrical placement.
- Power source location must be identified.
- For single power unit placed on table top, location will be centered as standard.
- For panel base placement, refer to page 8 for power unit standard locations.
- Panel bases and underside of tables feature removable panels for wire management accessibility.
- To add power cord exit to the exterior base panel, please specify -"PC02" and add \$75 List.

MODEL	DESCRIPTION	LIST
<p>PX4-B, Black Finish PX4-W, White Finish</p> 	<p>Power Matrix 4</p> <ul style="list-style-type: none"> ■ Dimensions: 7.25" W x 2.875" D ■ Two simplex outlets, one USB-A and one USB-C charging port. ■ 120" electrical cord. ■ UL listed. 	<p>559</p>

All shipments for this series will be blanket-wrapped as standard. For customers located in Territory 1 who require cartoning, a 5% upcharge will be added to each product. Please contact client services for additional information.

STRING GAMES MEETING TABLES - DAISY CHAIN COMPONENTS | Designed by Madsen & Contois

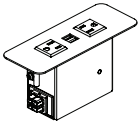

- Daisy chain units are required when more than one electrical unit is specified on one top.
- To determine jumper cable length, measure length from edge of electrical unit to end of table.
- Every connection point must be a female-to-male or male-to-female connection (all daisy chain power units feature male ends).

MODEL	DESCRIPTION	LIST												
PB3-DC-S, Silver Finish PB3-DC-W, White Finish 	Power Band 3 Daisy Chain <ul style="list-style-type: none"> ■ Dimensions: 6.5" W x 2.5" D ■ Two (2) simplex outlets and two (2) USB charging ports. ■ UL listed. 	724												
PB-ST-CD-72 	Power Band Starter Cable, 72" Long, Corded Plug Infeed <ul style="list-style-type: none"> ■ Must select either corded or hardwire starter cable, which goes from power source in wall or floor to first Power Band Unit. 	312												
PB-ST-HW-() 	Power Band Starter Cable, Hardwire Infeed <ul style="list-style-type: none"> ■ Must select either corded or hardwire starter cable, which goes from power source in wall or floor to first Power Band Unit. <table border="1"> <thead> <tr> <th>MODEL</th> <th>LENGTH</th> <th>LIST</th> </tr> </thead> <tbody> <tr> <td>PB-ST-HW-72</td> <td>72"</td> <td>216</td> </tr> <tr> <td>PB-ST-HW-108</td> <td>108"</td> <td>249</td> </tr> <tr> <td>PB-ST-HW-120</td> <td>120"</td> <td>277</td> </tr> </tbody> </table>	MODEL	LENGTH	LIST	PB-ST-HW-72	72"	216	PB-ST-HW-108	108"	249	PB-ST-HW-120	120"	277	see table
MODEL	LENGTH	LIST												
PB-ST-HW-72	72"	216												
PB-ST-HW-108	108"	249												
PB-ST-HW-120	120"	277												

All shipments for this series will be blanket-wrapped as standard. For customers located in Territory 1 who require cartoning, a 5% upcharge will be added to each product. Please contact client services for additional information.

STRING GAMES MEETING TABLES - DAISY CHAIN COMPONENTS | Designed by Madsen & Contois

- Daisy chain units are required when more than one electrical unit is specified on one top.
- To determine jumper cable length, measure length from edge of electrical unit to end of table.
- Every connection point must be a female-to-male or male-to-female connection (all daisy chain power units feature male ends).

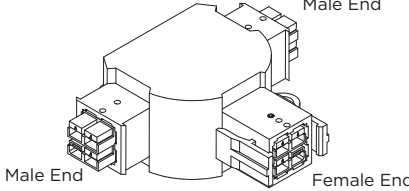
MODEL	DESCRIPTION	LIST																											
<p>PB-FF-()</p> 	<p>Power Band Jumper Cables, Female to Female</p> <ul style="list-style-type: none"> ■ Typically used to connect two (2) units together. ■ For additional lengths in 12" increments, please add \$25 List per foot. <table border="1"> <thead> <tr> <th>MODEL</th> <th>LENGTH</th> <th>LIST</th> </tr> </thead> <tbody> <tr> <td>PB-FF-12</td> <td>12"</td> <td>147</td> </tr> <tr> <td>PB-FF-24</td> <td>24"</td> <td>161</td> </tr> <tr> <td>PB-FF-30</td> <td>30"</td> <td>175</td> </tr> <tr> <td>PB-FF-36</td> <td>36"</td> <td>175</td> </tr> <tr> <td>PB-FF-48</td> <td>48"</td> <td>188</td> </tr> <tr> <td>PB-FF-54</td> <td>54"</td> <td>195</td> </tr> <tr> <td>PB-FF-60</td> <td>60"</td> <td>203</td> </tr> <tr> <td>PB-FF-72</td> <td>72"</td> <td>216</td> </tr> </tbody> </table>	MODEL	LENGTH	LIST	PB-FF-12	12"	147	PB-FF-24	24"	161	PB-FF-30	30"	175	PB-FF-36	36"	175	PB-FF-48	48"	188	PB-FF-54	54"	195	PB-FF-60	60"	203	PB-FF-72	72"	216	see table
MODEL	LENGTH	LIST																											
PB-FF-12	12"	147																											
PB-FF-24	24"	161																											
PB-FF-30	30"	175																											
PB-FF-36	36"	175																											
PB-FF-48	48"	188																											
PB-FF-54	54"	195																											
PB-FF-60	60"	203																											
PB-FF-72	72"	216																											
<p>PB-FM-()</p> 	<p>Power Band Jumper Cables, Female to Male</p> <ul style="list-style-type: none"> ■ Typically used to connect two (2) units together. ■ For additional lengths in 12" increments, please add \$25 List per foot. <table border="1"> <thead> <tr> <th>MODEL</th> <th>LENGTH</th> <th>LIST</th> </tr> </thead> <tbody> <tr> <td>PB-FM-12</td> <td>12"</td> <td>147</td> </tr> <tr> <td>PB-FM-24</td> <td>24"</td> <td>161</td> </tr> <tr> <td>PB-FM-30</td> <td>30"</td> <td>175</td> </tr> <tr> <td>PB-FM-36</td> <td>36"</td> <td>175</td> </tr> <tr> <td>PB-FM-48</td> <td>48"</td> <td>188</td> </tr> <tr> <td>PB-FM-54</td> <td>54"</td> <td>195</td> </tr> <tr> <td>PB-FM-60</td> <td>60"</td> <td>203</td> </tr> <tr> <td>PB-FM-72</td> <td>72"</td> <td>216</td> </tr> </tbody> </table>	MODEL	LENGTH	LIST	PB-FM-12	12"	147	PB-FM-24	24"	161	PB-FM-30	30"	175	PB-FM-36	36"	175	PB-FM-48	48"	188	PB-FM-54	54"	195	PB-FM-60	60"	203	PB-FM-72	72"	216	see table
MODEL	LENGTH	LIST																											
PB-FM-12	12"	147																											
PB-FM-24	24"	161																											
PB-FM-30	30"	175																											
PB-FM-36	36"	175																											
PB-FM-48	48"	188																											
PB-FM-54	54"	195																											
PB-FM-60	60"	203																											
PB-FM-72	72"	216																											
<p>PB-T</p> 	<p>Power Band T-Connector</p> <ul style="list-style-type: none"> ■ Used when power is needed to go in two directions. ■ Two (2) male ends and one (1) female end. 	195																											

All shipments for this series will be blanket-wrapped as standard. For customers located in Territory 1 who require cartoning, a 5% upcharge will be added to each product. Please contact client services for additional information.

STRING GAMES MEETING TABLES - POWER UNIT PLACEMENT | Designed by Madsen & Contois

Table Top Positioning

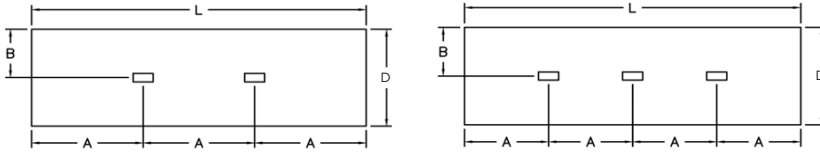

Panel Base (outside only, without exterior metal accent)

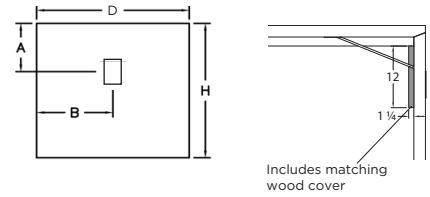

2 Power Units

W x L	A	B
24" x 60"	20"	12"
24" x 72"	24"	12"
24" x 84"	28"	12"
24" x 96"	32"	12"
30" x 60"	20"	15"
30" x 72"	24"	15"
30" x 84"	28"	15"
30" x 96"	32"	15"
36" x 60"	20"	18"
36" x 72"	24"	18"
36" x 84"	28"	18"
36" x 96"	32"	18"

3 Power Units

W x L	A	B
24" x 60"	15"	12"
24" x 72"	18"	12"
24" x 84"	21"	12"
24" x 96"	24"	12"
30" x 60"	15"	15"
30" x 72"	18"	15"
30" x 84"	21"	15"
30" x 96"	24"	15"
36" x 60"	15"	18"
36" x 72"	18"	18"
36" x 84"	21"	18"
36" x 96"	24"	18"

1 Power Unit

W x L	A	B
24" x 29"	8.75"	12"
30" x 29"	8.75"	15"
36" x 29"	8.75"	18"
24" x 42"	8.75"	12"
30" x 42"	8.75"	15"
36" x 42"	8.75"	18"

For custom power unit placement, please contact client services to verify that location can be accommodated.

All shipments for this series will be blanket-wrapped as standard. For customers located in Territory 1 who require cartoning, a 5% upcharge will be added to each product. Please contact client services for additional information.

SUITE BENCHES | Designed by David Dahl



SPECIFICATIONS:

- Tubular steel frame available in three standard finish options. Please refer to listing below.
- For custom metal finish colors, please contact client services for pricing.
- 600 lb. weight capacity.
- All dimensions are nominal.
- Refer to terms and conditions for general information regarding fabrics, finishes, warranty, freight, complete condition of sales and more.

STANDARD FRAME FINISH COLORS:



- 0405 Charcoal Grey
- 0535 Metallic Silver
- 0199 Chrome

All shipments for this series will be blanket-wrapped as standard. For customers located in Territory 1 who require cartoning, a 5% upcharge will be added to each product. Please contact client services for additional information.

SUITE BENCHES | Designed by David Dahl

ORDERING REQUIREMENTS:

- Model number
- Frame finish
- Upholstery selection
- Options, as applicable

MODEL	PRODUCT SPECIFICATIONS	FABRIC GRADES										LEATHER	
		COM	A	1	2	3	4	COL 5	6	7	8	L1	L2
7548 	48" Wide Bench 48" W x 22" D x 18" H COM: 2 yds. COL: 40 sq. ft. 38 lbs.	1,540	1,668	1,738	1,780	1,846	1,918	1,982	2,050	2,116	2,184	2,500	2,728
7560 	60" Wide Bench 60" W x 22" D x 18" H COM: 2 yds. COL: 40 sq. ft. 52 lbs.	1,838	1,966	2,036	2,078	2,144	2,216	2,280	2,348	2,414	2,482	2,798	3,026

OPTIONS

- | | | |
|--------|------------------|------|
| -VCT04 | VCT Tile Glides | \$28 |
| -MB02 | Moisture Barrier | \$89 |

SUITE GUEST + TANDEM | Designed by David Dahl



PRODUCT FEATURES:



ARM CAPS:

- Field-replaceable arm caps available on all models.



PASSIVE-FLEX BACK:

- Featured on all models including bariatric chair.
- Passive-flex back motion provides long-term seated comfort.

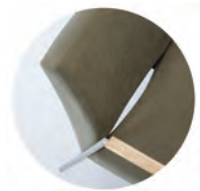

CLEAN-OUT:

- Featured on all seating units, with the exception of models 7510 and 7515.
- Clean-out area between seat and back enables crumbs and other debris to fall through for maintenance ease.



METAL SEAT FRAME:

- Metal seat frame construction ensures durability and allows in-field component replacement as well as add-on capability for tandem units.



OPTIONAL REPLACEABLE UPHOLSTERY:

- Available on seats and backs of all models, including bariatric chair.
- Replacement seat and back covers can be easily field installed on previously ordered Suite models with standard fixed upholstery. Contact client services for instructions.

SUITE GUEST + TANDEM | Designed by David Dahl

PRODUCT FEATURES, CONTINUED:

- Wall-saver leg design.
- Three standard frame finish options. Refer to options below.
- All dimensions are nominal.
- Refer to terms and conditions for general information regarding fabrics, finishes, warranty, freight, complete condition of sales and more.

GUEST/TANDEM SEATING:

- Arm and armless guest and tandem models.
- Bariatric models with arms also offered.
- Tandem models available in two and three-seat combinations or as reconfigurable modular units.
- Modular units offered with or without center arms.
- Three arm cap options: Beech wood, black urethane or solid surface.
- Wood arm caps available in all standard finishes on Beech.
- For Super Matte Sable Beech finish, upcharge applies. Refer to option section for pricing.
- For custom wood finishes, please add \$531 List per color per order.
- Solid surface arm caps available in white only.
- Tubular steel frame offered in three standard finishes. Refer to options below.
- Guest models feature 350 lb. weight capacity.
- Bariatric models feature 500 lb. weight capacity.
- VCT tile glides available for hard surface floors. Refer to individual pages for pricing.
- Include layout drawings or sketch with each tandem order.

CONNECTING TABLES:

- Three standard inline table options: 15" wide, 22" wide and 90-degree.
- End table offered in 22" width only.
- Wood veneer, laminate and solid surface top surface options.
- Wood top available in all standard finishes on Beech.
- For Super Matte Sable Beech finish, upcharge applies. Refer to option section for pricing.
- For custom wood finishes, please contact client services and add one-time upcharge of \$531 List per color per order.
- For custom laminate options, add \$649 List per color per order. Pre-approval required, please contact client services.
- Solid surface available in white only.
- Laminate tops are $\frac{3}{4}$ " thick. Solid surface tops are $\frac{1}{2}$ " thick over a $\frac{1}{2}$ " thick wood substrate.
- For all table widths, wood grain laminates will run parallel to width of table.
- Self edge standard. PVC edge also available on laminate tops only.
- Tables are field installed.
- Please include layout drawings or sketch with each tandem order.

STANDARD METAL FRAME FINISH COLORS:

- 0405 Charcoal Grey
- 0535 Metallic Silver
- 0199 Chrome

PVC EDGE COLORS:





- White
- Slate Grey
- Black

All shipments for this series will be blanket-wrapped as standard. For customers located in Territory 1 who require cartoning, a 5% upcharge will be added to each product. Please contact client services for additional information.

SUITE GUEST + TANDEM | Designed by David Dahl

ORDERING REQUIREMENTS:

- Model number
- Arm cap finish, as applicable
- Frame finish
- Upholstery selection
- Options, as applicable

MODEL	PRODUCT SPECIFICATIONS	FABRIC GRADES								LEATHER			
		COM	A	1	2	3	4	COL 5	6	7	8	L1	L2
7510 	Guest Chair, Armless 21" W x 25.5" D x 31.75" H Seat: 19" W x 18.5" D Seat Ht: 18" COM: 1.5 yds. COL: 30 sq. ft. 25 lbs.	1,434	1,530	1,583	1,614	1,664	1,718	1,766	1,817	1,866	1,917	2,154	2,325
7515-U 	Guest Chair, Black Urethane Arm Caps 21.75" W x 25.5" D x 31.75" H Seat: 19" W x 18.5" D Seat Ht: 18" Arm Ht: 25.75" COM: 1.5 yds. COL: 30 sq. ft. 26 lbs.	1,501	1,597	1,650	1,681	1,731	1,785	1,833	1,884	1,933	1,984	2,221	2,392
7515-W 	Guest Chair, Wood Arm Caps 21.75" W x 25.5" D x 31.75" H Seat: 19" W x 18.5" D Seat Ht: 18" Arm Ht: 25.75" COM: 1.5 yds. COL: 30 sq. ft. 26 lbs.	1,501	1,597	1,650	1,681	1,731	1,785	1,833	1,884	1,933	1,984	2,221	2,392
7515-SF 	Guest Chair, Solid Surface Arm Caps 21.75" W x 25.5" D x 31.75" H Seat: 19" W x 18.5" D Seat Ht: 18" Arm Ht: 25.75" COM: 1.5 yds. COL: 30 sq. ft. 26 lbs.	1,825	1,921	1,974	2,005	2,055	2,109	2,157	2,208	2,257	2,308	2,545	2,716

OPTIONS





-SM01	Super Matte Sable Wood Finish (per arm)	\$12
-SC01	Replaceable Seat Cover (per seat)	\$60
-BC01	Replaceable Back Cover (per back)	\$60
-MB01	Moisture Barrier (seat only)	\$68
-VCT04	VCT Tile Glides	\$28

All shipments for this series will be blanket-wrapped as standard. For customers located in Territory 1 who require cartoning, a 5% upcharge will be added to each product. Please contact client services for additional information.

SUITE GUEST + TANDEM | Designed by David Dahl

ORDERING REQUIREMENTS:

- Model number
- Arm cap finish, as applicable
- Frame finish
- Upholstery selection
- Options, as applicable

MODEL	PRODUCT SPECIFICATIONS	FABRIC GRADES								LEATHER			
		COM	A	1	2	3	4	COL 5	6	7	8	L1	L2
7511 	Guest Chair with Cleanout, Armless 21" W x 25.5" D x 31.75" H Seat: 19" W x 18.5" D Seat Ht: 18" COM: 1.5 yds. COL: 30 sq. ft. 25 lbs.	1,495	1,591	1,644	1,675	1,725	1,779	1,827	1,878	1,927	1,978	2,215	2,386
7521-U 	Guest Chair with Cleanout, Black Urethane Arm Caps 21.75" W x 25.5" D x 31.75" H Seat: 19" W x 18.5" D Seat Ht: 18" Arm Ht: 25.75" COM: 1.5 yds. COL: 30 sq. ft. 26 lbs.	1,564	1,660	1,713	1,744	1,794	1,848	1,896	1,947	1,996	2,047	2,284	2,455
7521-W 	Guest Chair with Cleanout, Wood Arm Caps 21.75" W x 25.5" D x 31.75" H Seat: 19" W x 18.5" D Seat Ht: 18" Arm Ht: 25.75" COM: 1.5 yds. COL: 30 sq. ft. 26 lbs.	1,564	1,660	1,713	1,744	1,794	1,848	1,896	1,947	1,996	2,047	2,284	2,455
7521-SF 	Guest Chair with Cleanout, Solid Surface Caps 21.75" W x 25.5" D x 31.75" H Seat: 19" W x 18.5" D Seat Ht: 18" Arm Ht: 25.75" COM: 1.5 yds. COL: 30 sq. ft. 26 lbs.	1,888	1,984	2,037	2,068	2,118	2,172	2,220	2,271	2,320	2,371	2,608	2,779

OPTIONS



-SM01	Super Matte Sable Wood Finish (per arm)	\$12
-SC01	Replaceable Seat Cover (per seat)	\$60
-BC01	Replaceable Back Cover (per back)	\$60
-MB01	Moisture Barrier (seat only)	\$68
-VCT04	VCT Tile Glides	\$28

All shipments for this series will be blanket-wrapped as standard. For customers located in Territory 1 who require cartoning, a 5% upcharge will be added to each product. Please contact client services for additional information.

SUITE GUEST + TANDEM | Designed by David Dahl

ORDERING REQUIREMENTS:

- Model number
- Arm cap finish, as applicable
- Frame finish
- Upholstery selection
- Options, as applicable

MODEL	PRODUCT SPECIFICATIONS	FABRIC GRADES										LEATHER	
		COM	A	1	2	3	4	COL 5	6	7	8	L1	L2
7522-U	 <p>Tandem Two-Seater, Black Urethane Arm Caps 42" W x 25.5" D x 31.75" H Seat: 19" W x 18.5" D Seat Ht: 18" Arm Ht: 25.75" COM: 3 yds. COL: 60 sq. ft. 48 lbs.</p>	2,835	3,027	3,132	3,195	3,294	3,402	3,498	3,600	3,699	3,801	4,275	4,617
7522-W	 <p>Tandem Two-Seater, Wood Arm Caps 42" W x 25.5" D x 31.75" H Seat: 19" W x 18.5" D Seat Ht: 18" Arm Ht: 25.75" COM: 3 yds. COL: 60 sq. ft. 48 lbs.</p>	2,835	3,027	3,132	3,195	3,294	3,402	3,498	3,600	3,699	3,801	4,275	4,617
7522-SF	 <p>Tandem Two-Seater, Solid Surface Arm Caps 42" W x 25.5" D x 31.75" H Seat: 19" W x 18.5" D Seat Ht: 18" Arm Ht: 25.75" COM: 3 yds. COL: 60 sq. ft. 48 lbs.</p>	3,321	3,513	3,618	3,681	3,780	3,888	3,984	4,086	4,185	4,287	4,761	5,103

OPTIONS

-SM01	Super Matte Sable Wood Finish (per arm)	\$12
-SC03	Replaceable Seat Cover (per two-seat unit)	\$126
-BC03	Replaceable Back Cover (per two-seat unit)	\$126
-MB04	Moisture Barrier (seat only, per two-seat unit)	\$126
-VCT02	VCT Tile Glides (per arm frame)	\$14

All shipments for this series will be blanket-wrapped as standard. For customers located in Territory 1 who require cartoning, a 5% upcharge will be added to each product. Please contact client services for additional information.

SUITE GUEST + TANDEM | Designed by David Dahl

ORDERING REQUIREMENTS:

- Model number
- Arm cap finish, as applicable
- Frame finish
- Upholstery selection
- Options, as applicable

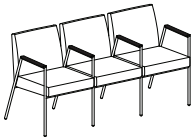
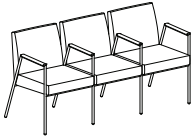
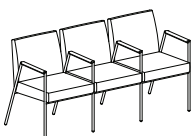
MODEL	PRODUCT SPECIFICATIONS	FABRIC GRADES								LEATHER			
		COM	A	1	2	3	4	COL 5	6	7	8	L1	L2
7523-U	 <p>Tandem Three-Seater, Black Urethane Arm Caps 62" W x 25.5" D x 31.75" H Seat: 19" W x 18.5" D Seat Ht: 18" Arm Ht: 25.75" COM: 4.5 yds. COL: 90 sq. ft. 70 lbs.</p>	4,181	4,469	4,627	4,721	4,870	5,032	5,176	5,329	5,477	5,630	6,341	6,854
7523-W	 <p>Tandem Three-Seater, Wood Arm Caps 62" W x 25.5" D x 31.75" H Seat: 19" W x 18.5" D Seat Ht: 18" Arm Ht: 25.75" COM: 4.5 yds. COL: 90 sq. ft. 70 lbs.</p>	4,181	4,469	4,627	4,721	4,870	5,032	5,176	5,329	5,477	5,630	6,341	6,854
7523-SF	 <p>Tandem Three-Seater, Solid Surface Arm Caps 62" W x 25.5" D x 31.75" H Seat: 19" W x 18.5" D Seat Ht: 18" Arm Ht: 25.75" COM: 4.5 yds. COL: 90 sq. ft. 70 lbs.</p>	4,829	5,117	5,275	5,369	5,518	5,680	5,824	5,977	6,125	6,278	6,989	7,502

OPTIONS

-SM01	Super Matte Sable Wood Finish (per arm)	\$12
-SC04	Replaceable Seat Cover (per three-seat unit)	\$189
-BC04	Replaceable Back Cover (per three-seat unit)	\$189
-MB05	Moisture Barrier (seat only, per three-seat unit)	\$189
-VCT02	VCT Tile Glides (per arm frame)	\$14

All shipments for this series will be blanket-wrapped as standard. For customers located in Territory 1 who require cartoning, a 5% upcharge will be added to each product. Please contact client services for additional information.

SUITE GUEST + TANDEM | Designed by David Dahl

ORDERING GUIDELINES:

- To build tandem configurations, always specify units from left-to-right as facing.
- Starter units ("-ST") represent the first seating model in a configuration with subsequent modular units building onto them towards the right.
- Add-on units ("-AO") can only be added next to starter units or other add-on units.
- End-units ("-EU") represent the final seating model in a configuration.
- Center and corner tables are for in-line placement only (cannot start or end a configuration) and for specification purposes, will always come before a starter unit, after an end unit or before/after a single chair (i.e. add-on units cannot be specified next to connecting tables).
- End tables can only start or end a configuration, therefore they will always come before a starter unit or after an end unit (i.e. add-on units cannot be specified next to connecting tables).

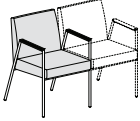
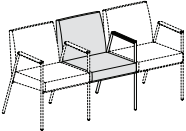
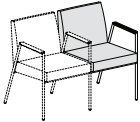
MODEL	PRODUCT SPECIFICATIONS	FABRIC GRADES										LEATHER	
		COM	A	1	2	3	4	COL 5	6	7	8	L1	L2
7520-ST-U	 <p>Tandem Starter Unit, Black Urethane Arm Caps 21.75" W x 25.5" D x 31.75" H Seat: 19" W x 18.5" D Seat Ht: 18" Arm Ht: 25.75" COM: 1.5 yds. COL: 30 sq. ft. 26 lbs.</p>	1,561	1,657	1,710	1,741	1,791	1,845	1,893	1,944	1,993	2,044	2,281	2,452
7520-AO-U	 <p>Tandem Add-On Unit, Black Urethane Arm Cap 20" W x 25.5" D x 31.75" H Seat: 19" W x 18.5" D Seat Ht: 18" Arm Ht: 25.75" COM: 1.5 yds. COL: 30 sq. ft. 22 lbs.</p>	1,398	1,494	1,547	1,578	1,628	1,682	1,730	1,781	1,830	1,881	2,118	2,289
7520-EU-U	 <p>Tandem End Unit, Black Urethane Arm Cap 20" W x 25.5" D x 31.75" H Seat: 19" W x 18.5" D Seat Ht: 18" Arm Ht: 25.75" COM: 1.5 yds. COL: 30 sq. ft. 22 lbs.</p>	1,381	1,477	1,530	1,561	1,611	1,665	1,713	1,764	1,813	1,864	2,101	2,272

OPTIONS

-SC01	Replaceable Seat Cover (per seat)	\$60	-VCT04	VCT Tile Glides (starter unit)	\$28
-BC01	Replaceable Back Cover (per back)	\$60	-VCT02	VCT Tile Glides (add-on and end units)	\$14
-MB01	Moisture Barrier (seat only, per unit)	\$68			

All shipments for this series will be blanket-wrapped as standard. For customers located in Territory 1 who require cartoning, a 5% upcharge will be added to each product. Please contact client services for additional information.

SUITE GUEST + TANDEM | Designed by David Dahl

ORDERING GUIDELINES:

- To build tandem configurations, always specify units from left-to-right as facing.
- Starter units ("-ST") represent the first seating model in a configuration with subsequent modular units building onto them towards the right.
- Add-on units ("-AO") can only be added next to starter units or other add-on units.
- End-units ("-EU") represent the final seating model in a configuration.
- Center and corner tables are for in-line placement only (cannot start or end a configuration) and for specification purposes, will always come before a starter unit, after an end unit or before/after a single chair (i.e. add-on units cannot be specified next to connecting tables).
- End tables can only start or end a configuration, therefore they will always come before a starter unit or after an end unit (i.e. add-on units cannot be specified next to connecting tables).

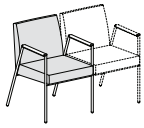
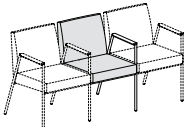
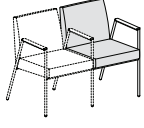
MODEL	PRODUCT SPECIFICATIONS	FABRIC GRADES								LEATHER			
		COM	A	1	2	3	4	COL 5	6	7	8	L1	L2
7520-ST-W 	Tandem Starter Unit, Wood Arm Caps 21.75" W x 25.5" D x 31.75" H Seat: 19" W x 18.5" D Seat Ht: 18" Arm Ht: 25.75" COM: 1.5 yds. COL: 30 sq. ft. 26 lbs.	1,561	1,657	1,710	1,741	1,791	1,845	1,893	1,944	1,993	2,044	2,281	2,452
7520-AO-W 	Tandem Add-On Unit, Wood Arm Cap 20" W x 25.5" D x 31.75" H Seat: 19" W x 18.5" D Seat Ht: 18" Arm Ht: 25.75" COM: 1.5 yds. COL: 30 sq. ft. 22 lbs.	1,398	1,494	1,547	1,578	1,628	1,682	1,730	1,781	1,830	1,881	2,118	2,289
7520-EU-W 	Tandem End Unit, Wood Arm Cap 20" W x 25.5" D x 31.75" H Seat: 19" W x 18.5" D Seat Ht: 18" Arm Ht: 25.75" COM: 1.5 yds. COL: 30 sq. ft. 22 lbs.	1,381	1,477	1,530	1,561	1,611	1,665	1,713	1,764	1,813	1,864	2,101	2,272

OPTIONS

-SM01	Super Matte Sable Wood Finish (per arm)	\$12	-VCT04	VCT Tile Glides (starter unit)	\$28
-SC01	Replaceable Seat Cover (per seat)	\$60	-VCT02	VCT Tile Glides (add-on and end units)	\$14
-BC01	Replaceable Back Cover (per back)	\$60			
-MB01	Moisture Barrier (seat only, per unit)	\$68			

All shipments for this series will be blanket-wrapped as standard. For customers located in Territory 1 who require cartoning, a 5% upcharge will be added to each product. Please contact client services for additional information.

SUITE GUEST + TANDEM | Designed by David Dahl

ORDERING GUIDELINES:

- To build tandem configurations, always specify units from left-to-right as facing.
- Starter units ("-ST") represent the first seating model in a configuration with subsequent modular units building onto them towards the right.
- Add-on units ("-AO") can only be added next to starter units or other add-on units.
- End-units ("-EU") represent the final seating model in a configuration.
- Center and corner tables are for in-line placement only (cannot start or end a configuration) and for specification purposes, will always come before a starter unit, after an end unit or before/after a single chair (i.e. add-on units cannot be specified next to connecting tables).
- End tables can only start or end a configuration, therefore they will always come before a starter unit or after an end unit (i.e. add-on units cannot be specified next to connecting tables).

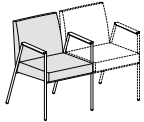
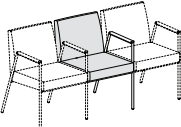
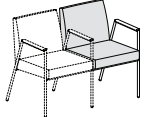
MODEL	PRODUCT SPECIFICATIONS	FABRIC GRADES										LEATHER	
		COM	A	1	2	3	4	COL 5	6	7	8	L1	L2
7520-ST-SF 	Tandem Starter Unit, Solid Surface Arm Caps 21.75" W x 25.5" D x 31.75" H Seat: 19" W x 18.5" D Seat Ht: 18" Arm Ht: 25.75" COM: 1.5 yds. COL: 30 sq. ft. 26 lbs.	1,885	1,981	2,034	2,065	2,115	2,169	2,217	2,268	2,317	2,368	2,605	2,776
7520-AO-SF 	Tandem Add-On Unit, Solid Surface Arm Cap 20" W x 25.5" D x 31.75" H Seat: 19" W x 18.5" D Seat Ht: 18" Arm Ht: 25.75" COM: 1.5 yds. COL: 30 sq. ft. 22 lbs.	1,722	1,818	1,871	1,902	1,952	2,006	2,054	2,105	2,154	2,205	2,442	2,613
7520-EU-SF 	Tandem End Unit, Solid Surface Arm Cap 20" W x 25.5" D x 31.75" H Seat: 19" W x 18.5" D Seat Ht: 18" Arm Ht: 25.75" COM: 1.5 yds. COL: 30 sq. ft. 22 lbs.	1,543	1,639	1,692	1,723	1,773	1,827	1,875	1,926	1,975	2,026	2,263	2,434

OPTIONS



-SC01	Replaceable Seat Cover (per seat)	\$60	-VCT04	VCT Tile Glides (starter unit)	\$28
-BC01	Replaceable Back Cover (per back)	\$60	-VCT02	VCT Tile Glides (add-on and end units)	\$14
-MB01	Moisture Barrier (seat only, per unit)	\$68			

All shipments for this series will be blanket-wrapped as standard. For customers located in Territory 1 who require cartoning, a 5% upcharge will be added to each product. Please contact client services for additional information.

SUITE GUEST + TANDEM | Designed by David Dahl

ORDERING GUIDELINES:

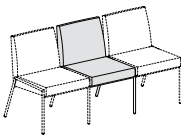
- To build tandem configurations, always specify units from left-to-right as facing.
- Starter units ("-ST") represent the first seating model in a configuration with subsequent modular units building onto them towards the right.
- Add-on units ("-AO") can only be added next to starter units or other add-on units.
- End-units ("-EU") represent the final seating model in a configuration.
- Center and corner tables are for in-line placement only (cannot start or end a configuration) and for specification purposes, will always come before a starter unit, after an end unit or before/after a single chair (i.e. add-on units cannot be specified next to connecting tables).
- End tables can only start or end a configuration, therefore they will always come before a starter unit or after an end unit (i.e. add-on units cannot be specified next to connecting tables).

MODEL	PRODUCT SPECIFICATIONS	FABRIC GRADES										LEATHER	
		COM	A	1	2	3	4	COL 5	6	7	8	L1	L2
7530-ST 	Tandem Starter Unit, Armless 21" W x 25.5" D x 31.75" H Seat: 19" W x 18.5" D Seat Ht: 18" COM: 1.5 yds. COL: 30 sq. ft. 25 lbs.	1,386	1,482	1,535	1,566	1,616	1,670	1,718	1,769	1,818	1,869	2,106	2,277
7530-AO 	Tandem Add-On Unit, Armless 20.25" W x 25.5" D x 31.75" H Seat: 19" W x 18.5" D Seat Ht: 18" COM: 1.5 yds. COL: 30 sq. ft. 21 lbs.	1,320	1,416	1,469	1,500	1,550	1,604	1,652	1,703	1,752	1,803	2,040	2,211
7530-EU 	Tandem End Unit, Armless 20.25" W x 25.5" D x 31.75" H Seat: 19" W x 18.5" D Seat Ht: 18" COM: 1.5 yds. COL: 30 sq. ft. 21 lbs.	1,304	1,400	1,453	1,484	1,534	1,588	1,636	1,687	1,736	1,787	2,024	2,195

OPTIONS



-SC01	Replaceable Seat Cover (per seat)	\$60	-VCT04	VCT Tile Glides (starter unit)	\$28
-BC01	Replaceable Back Cover (per back)	\$60	-VCT02	VCT Tile Glides (add-on and end units)	\$14
-MB01	Moisture Barrier (seat only, per unit)	\$68			

All shipments for this series will be blanket-wrapped as standard. For customers located in Territory 1 who require cartoning, a 5% upcharge will be added to each product. Please contact client services for additional information.

SUITE GUEST + TANDEM | Designed by David Dahl

ORDERING GUIDELINES:

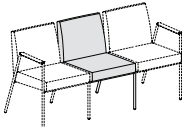
- To build tandem configurations, always specify units from left-to-right as facing.
- Starter units ("-ST") represent the first seating model in a configuration with subsequent modular units building onto them towards the right.
- Add-on units ("-AO") can only be added next to starter units or other add-on units.
- End-units ("-EU") represent the final seating model in a configuration.
- Center and corner tables are for in-line placement only (cannot start or end a configuration) and for specification purposes, will always come before a starter unit, after an end unit or before/after a single chair (i.e. add-on units cannot be specified next to connecting tables).
- End tables can only start or end a configuration, therefore they will always come before a starter unit or after an end unit (i.e. add-on units cannot be specified next to connecting tables).

MODEL	PRODUCT SPECIFICATIONS	FABRIC GRADES								LEATHER			
		COM	A	1	2	3	4	COL 5	6	7	8	L1	L2
7535-ST-U 	Tandem Starter Unit, Black Urethane Arm Cap, Armless 21.5" W x 25.5" D x 31.75" H Seat: 19" W x 18.5" D Seat Ht: 18" Arm Ht: 25.75" COM: 1.5 yds. COL: 30 sq. ft. 25 lbs.	1,468	1,564	1,617	1,648	1,698	1,752	1,800	1,851	1,900	1,951	2,188	2,359
7530-AO 	Tandem Add-On Unit, Armless 20.25" W x 25.5" D x 31.75" H Seat: 19" W x 18.5" D Seat Ht: 18" COM: 1.5 yds. COL: 30 sq. ft. 21 lbs.	1,320	1,416	1,469	1,500	1,550	1,604	1,652	1,703	1,752	1,803	2,040	2,211
7535-EU-U 	Tandem End Unit, Armless, Black Urethane Arm Cap 21.5" W x 25.5" D x 31.75" H Seat: 19" W x 18.5" D Seat Ht: 18" Arm Ht: 25.75" COM: 1.5 yds. COL: 30 sq. ft. 25 lbs.	1,379	1,475	1,528	1,559	1,609	1,663	1,711	1,762	1,811	1,862	2,099	2,270

OPTIONS



-SC01	Replaceable Seat Cover (per seat)	\$60	-VCT04	VCT Tile Glides (starter unit)	\$28
-BC01	Replaceable Back Cover (per back)	\$60	-VCT02	VCT Tile Glides (add-on and end units)	\$14
-MB01	Moisture Barrier (seat only, per unit)	\$68			

All shipments for this series will be blanket-wrapped as standard. For customers located in Territory 1 who require cartoning, a 5% upcharge will be added to each product. Please contact client services for additional information.

SUITE GUEST + TANDEM | Designed by David Dahl

ORDERING GUIDELINES:

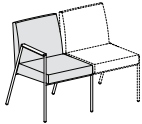
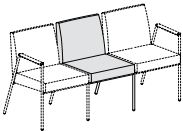
- To build tandem configurations, always specify units from left-to-right as facing.
- Starter units ("-ST") represent the first seating model in a configuration with subsequent modular units building onto them towards the right.
- Add-on units ("-AO") can only be added next to starter units or other add-on units.
- End-units ("-EU") represent the final seating model in a configuration.
- Center and corner tables are for in-line placement only (cannot start or end a configuration) and for specification purposes, will always come before a starter unit, after an end unit or before/after a single chair (i.e. add-on units cannot be specified next to connecting tables).
- End tables can only start or end a configuration, therefore they will always come before a starter unit or after an end unit (i.e. add-on units cannot be specified next to connecting tables).

MODEL	PRODUCT SPECIFICATIONS	FABRIC GRADES								LEATHER			
		COM	A	1	2	3	4	COL 5	6	7	8	L1	L2
7535-ST-W 	Tandem Starter Unit, Wood Arm Cap, Armless 21.5" W x 25.5" D x 31.75" H Seat: 19" W x 18.5" D Seat Ht: 18" Arm Ht: 25.75" COM: 1.5 yds. COL: 30 sq. ft. 25 lbs.	1,468	1,564	1,617	1,648	1,698	1,752	1,800	1,851	1,900	1,951	2,188	2,359
7530-AO 	Tandem Add-On Unit, Armless 20.25" W x 25.5" D x 31.75" H Seat: 19" W x 18.5" D Seat Ht: 18" COM: 1.5 yds. COL: 30 sq. ft. 21 lbs.	1,320	1,416	1,469	1,500	1,550	1,604	1,652	1,703	1,752	1,803	2,040	2,211
7535-EU-W 	Tandem End Unit, Armless, Wood Arm Cap 21.5" W x 25.5" D x 31.75" H Seat: 19" W x 18.5" D Seat Ht: 18" Arm Ht: 25.75" COM: 1.5 yds. COL: 30 sq. ft. 25 lbs.	1,379	1,475	1,528	1,559	1,609	1,663	1,711	1,762	1,811	1,862	2,099	2,270

OPTIONS



-SM01	Super Matte Sable Wood Finish (per arm)	\$12	-VCT04	VCT Tile Glides (starter unit)	\$28
-SC01	Replaceable Seat Cover (per seat)	\$60	-VCT02	VCT Tile Glides (add-on and end units)	\$14
-BC01	Replaceable Back Cover (per back)	\$60			
-MB01	Moisture Barrier (seat only, per unit)	\$68			

All shipments for this series will be blanket-wrapped as standard. For customers located in Territory 1 who require cartoning, a 5% upcharge will be added to each product. Please contact client services for additional information.

SUITE GUEST + TANDEM | Designed by David Dahl

ORDERING GUIDELINES:

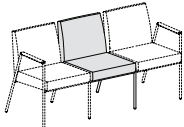
- To build tandem configurations, always specify units from left-to-right as facing.
- Starter units ("-ST") represent the first seating model in a configuration with subsequent modular units building onto them towards the right.
- Add-on units ("-AO") can only be added next to starter units or other add-on units.
- End-units ("-EU") represent the final seating model in a configuration.
- Center and corner tables are for in-line placement only (cannot start or end a configuration) and for specification purposes, will always come before a starter unit, after an end unit or before/after a single chair (i.e. add-on units cannot be specified next to connecting tables).
- End tables can only start or end a configuration, therefore they will always come before a starter unit or after an end unit (i.e. add-on units cannot be specified next to connecting tables).

MODEL	PRODUCT SPECIFICATIONS	FABRIC GRADES								LEATHER			
		COM	A	1	2	3	4	COL 5	6	7	8	L1	L2
7535-ST-SF 	Tandem Starter Unit, Solid Surface Arm Cap, Armless 21.5" W x 25.5" D x 31.75" H Seat: 19" W x 18.5" D Seat Ht: 18" Arm Ht: 25.75" COM: 1.5 yds. COL: 30 sq. ft. 25 lbs.	1,792	1,888	1,941	1,972	2,022	2,076	2,124	2,175	2,224	2,275	2,512	2,683
7530-AO 	Tandem Add-On Unit, Armless 20.25" W x 25.5" D x 31.75" H Seat: 19" W x 18.5" D Seat Ht: 18" COM: 1.5 yds. COL: 30 sq. ft. 21 lbs.	1,320	1,416	1,469	1,500	1,550	1,604	1,652	1,703	1,752	1,803	2,040	2,211
7535-EU-SF 	Tandem End Unit, Armless, Solid Surface Arm Cap 21.5" W x 25.25" D x 31.75" H Seat: 19" W x 18.5" D Seat Ht: 18" Arm Ht: 25.75" COM: 1.5 yds. COL: 30 sq. ft. 25 lbs.	1,541	1,637	1,690	1,721	1,771	1,825	1,873	1,924	1,973	2,024	2,261	2,432

OPTIONS



-SC01	Replaceable Seat Cover (per seat)	\$60	-VCT04	VCT Tile Glides (starter unit)	\$28
-BC01	Replaceable Back Cover (per back)	\$60	-VCT02	VCT Tile Glides (add-on and end units)	\$14
-MB01	Moisture Barrier (seat only, per unit)	\$68			

All shipments for this series will be blanket-wrapped as standard. For customers located in Territory 1 who require cartoning, a 5% upcharge will be added to each product. Please contact client services for additional information.

SUITE GUEST + TANDEM | Designed by David Dahl

ORDERING REQUIREMENTS:

- Model number
- Arm cap finish, as applicable
- Frame finish
- Upholstery selection
- Options, as applicable

MODEL	PRODUCT SPECIFICATIONS	FABRIC GRADES								LEATHER			
		COM	A	1	2	3	4	COL 5	6	7	8	L1	L2
7550-U	 <p>Single Bariatric Chair, Black Urethane Arm Caps 31.75" W x 25.5" D x 31.75" H Seat: 29" W x 19" D Seat Ht: 18" Arm Ht: 25.75" COM: 2 yds. COL: 40 sq. ft. 33 lbs.</p>	1,879	2,007	2,077	2,119	2,185	2,257	2,321	2,389	2,455	2,523	2,839	3,067
7550-W	 <p>Single Bariatric Chair, Wood Arm Caps 31.75" W x 25.5" D x 31.75" H Seat: 29" W x 19" D Seat Ht: 18" Arm Ht: 25" COM: 2 yds. COL: 40 sq. ft. 33 lbs.</p>	1,879	2,007	2,077	2,119	2,185	2,257	2,321	2,389	2,455	2,523	2,839	3,067
7550-SF	 <p>Single Bariatric Chair, Solid Surface Arm Caps 31.75" W x 25.5" D x 31.75" H Seat: 29" W x 19" D Seat Ht: 18" Arm Ht: 25.75" COM: 2 yds. COL: 40 sq. ft. 33 lbs.</p>	2,203	2,331	2,401	2,443	2,509	2,581	2,645	2,713	2,779	2,847	3,163	3,391

OPTIONS

-SM01	Super Matte Sable Wood Finish (per arm)	\$12	-VCT04	VCT Tile Glides	\$28
-SC02	Replaceable Seat Cover (per seat)	\$73			
-BC02	Replaceable Back Cover (per back)	\$67			
-MB02	Moisture Barrier (seat only, per unit)	\$89			

All shipments for this series will be blanket-wrapped as standard. For customers located in Territory 1 who require cartoning, a 5% upcharge will be added to each product. Please contact client services for additional information.

SUITE GUEST + TANDEM | Designed by David Dahl

ORDERING GUIDELINES:

- To build tandem configurations, always specify units from left-to-right as facing.
- Starter units ("-ST") represent the first seating model in a configuration with subsequent modular units building onto them towards the right.
- Add-on units ("-AO") can only be added next to starter units or other add-on units.
- End-units ("-EU") represent the final seating model in a configuration.
- Center and corner tables are for in-line placement only (cannot start or end a configuration) and for specification purposes, will always come before a starter unit, after an end unit or before/after a single chair (i.e. add-on units cannot be specified next to connecting tables).
- End tables can only start or end a configuration, therefore they will always come before a starter unit or after an end unit (i.e. add-on units cannot be specified next to connecting tables).

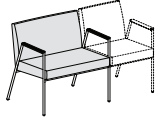
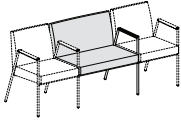
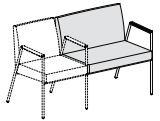
MODEL	PRODUCT SPECIFICATIONS	FABRIC GRADES								LEATHER			
		COM	A	1	2	3	4	COL 5	6	7	8	L1	L2
7550-ST-U 	Bariatric Starter Unit, Black Urethane Arm Caps 31.75" W x 25.5" D x 31.75" H Seat: 29" W x 19" D Seat Ht: 18" Arm Ht: 25.75" COM: 2 yds. COL: 40 sq. ft. 33 lbs.	1,870	1,998	2,068	2,110	2,176	2,248	2,312	2,380	2,446	2,514	2,830	3,058
7550-AO-U 	Bariatric Add-On Unit, Black Urethane Arm Cap 30.5" W x 25.5" D x 31.75" H Seat: 29" W x 19" D Seat Ht: 18" Arm Ht: 25.75" COM: 2 yds. COL: 40 sq. ft. 29 lbs.	1,716	1,844	1,914	1,956	2,022	2,094	2,158	2,226	2,292	2,360	2,676	2,904
7550-EU-U 	Bariatric End Unit, Black Urethane Arm Cap 30.5" W x 25.5" D x 31.75" H Seat: 29" W x 19" D Seat Ht: 18" Arm Ht: 25.75" COM: 2 yds. COL: 40 sq. ft. 29 lbs.	1,700	1,828	1,898	1,940	2,006	2,078	2,142	2,210	2,276	2,344	2,660	2,888

OPTIONS

-SC02	Replaceable Seat Cover (per seat)	\$73	-VCT04	VCT Tile Glides (starter unit)	\$28
-BC02	Replaceable Back Cover (per back)	\$67	-VCT02	VCT Tile Glides (add-on and end units)	\$14
-MB02	Moisture Barrier (seat only, per unit)	\$89			

All shipments for this series will be blanket-wrapped as standard. For customers located in Territory 1 who require cartoning, a 5% upcharge will be added to each product. Please contact client services for additional information.

SUITE GUEST + TANDEM | Designed by David Dahl

ORDERING GUIDELINES:

- To build tandem configurations, always specify units from left-to-right as facing.
- Starter units ("-ST") represent the first seating model in a configuration with subsequent modular units building onto them towards the right.
- Add-on units ("-AO") can only be added next to starter units or other add-on units.
- End-units ("-EU") represent the final seating model in a configuration.
- Center and corner tables are for in-line placement only (cannot start or end a configuration) and for specification purposes, will always come before a starter unit, after an end unit or before/after a single chair (i.e. add-on units cannot be specified next to connecting tables).
- End tables can only start or end a configuration, therefore they will always come before a starter unit or after an end unit (i.e. add-on units cannot be specified next to connecting tables).

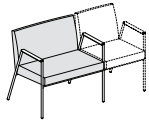
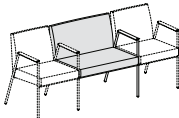
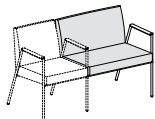
MODEL	PRODUCT SPECIFICATIONS	FABRIC GRADES								LEATHER			
		COM	A	1	2	3	4	COL 5	6	7	8	L1	L2
7550-ST-W 	Bariatric Starter Unit, Wood Arm Caps 31.75" W x 25.5" D x 31.75" H Seat: 29" W x 19" D Seat Ht: 18" Arm Ht: 25.75" COM: 2 yds. COL: 40 sq. ft. 33 lbs.	1,870	1,998	2,068	2,110	2,176	2,248	2,312	2,380	2,446	2,514	2,830	3,058
7550-AO-W 	Bariatric Add-On Unit, Wood Arm Cap 30.5" W x 25.5" D x 31.75" H Seat: 29" W x 19" D Seat Ht: 18" Arm Ht: 25.75" COM: 2 yds. COL: 40 sq. ft. 29 lbs.	1,716	1,844	1,914	1,956	2,022	2,094	2,158	2,226	2,292	2,360	2,676	2,904
7550-EU-W 	Bariatric End Unit Wood Arm Cap 30.5" W x 25.5" D x 31.75" H Seat: 29" W x 19" D Seat Ht: 18" Arm Ht: 25.75" COM: 2 yds. COL: 40 sq. ft. 29 lbs.	1,700	1,828	1,898	1,940	2,006	2,078	2,142	2,210	2,276	2,344	2,660	2,888

OPTIONS



-SM01	Super Matte Sable Wood Finish (per arm)	\$12	-VCT04	VCT Tile Glides (starter unit)	\$28
-SC02	Replaceable Seat Cover (per seat)	\$73	-VCT02	VCT Tile Glides (add-on and end units)	\$14
-BC02	Replaceable Back Cover (per back)	\$67			
-MB02	Moisture Barrier (seat only, per unit)	\$89			

All shipments for this series will be blanket-wrapped as standard. For customers located in Territory 1 who require cartoning, a 5% upcharge will be added to each product. Please contact client services for additional information.

SUITE GUEST + TANDEM | Designed by David Dahl

ORDERING GUIDELINES:

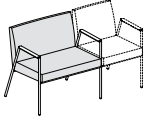
- To build tandem configurations, always specify units from left-to-right as facing.
- Starter units ("-ST") represent the first seating model in a configuration with subsequent modular units building onto them towards the right.
- Add-on units ("-AO") can only be added next to starter units or other add-on units.
- End-units ("-EU") represent the final seating model in a configuration.
- Center and corner tables are for in-line placement only (cannot start or end a configuration) and for specification purposes, will always come before a starter unit, after an end unit or before/after a single chair (i.e. add-on units cannot be specified next to connecting tables).
- End tables can only start or end a configuration, therefore they will always come before a starter unit or after an end unit (i.e. add-on units cannot be specified next to connecting tables).

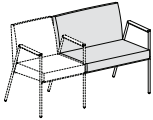
MODEL	PRODUCT SPECIFICATIONS	FABRIC GRADES								LEATHER			
		COM	A	1	2	3	4	COL 5	6	7	8	L1	L2
7550-ST-SF 	Bariatric Starter Unit, Solid Surface Arm Caps 31.75" W x 25.5" D x 31.75" H Seat: 29" W x 19" D Seat Ht: 18" Arm Ht: 25.75" COM: 2 yds. COL: 40 sq. ft. 33 lbs.	2,194	2,322	2,392	2,434	2,500	2,572	2,636	2,704	2,770	2,838	3,154	3,382
7550-AO-SF 	Bariatric Add-On Unit, Solid Surface Arm Cap 30.5" W x 25.5" D x 31.75" H Seat: 29" W x 19" D Seat Ht: 18" Arm Ht: 25.75" COM: 2 yds. COL: 40 sq. ft. 29 lbs.	1,878	2,006	2,076	2,118	2,184	2,256	2,320	2,388	2,454	2,522	2,838	3,066
7550-EU-SF 	Bariatric End Unit Solid Surface Arm Cap 30.5" W x 25.5" D x 31.75" H Seat: 29" W x 19" D Seat Ht: 18" Arm Ht: 25.75" COM: 2 yds. COL: 40 sq. ft. 29 lbs.	1,862	1,990	2,060	2,102	2,168	2,240	2,304	2,372	2,438	2,506	2,822	3,050

OPTIONS

-SC02	Replaceable Seat Cover (per seat)	\$73	-VCT04	VCT Tile Glides (starter unit)	\$28
-BC02	Replaceable Back Cover (per back)	\$67	-VCT02	VCT Tile Glides (add-on and end units)	\$14
-MB02	Moisture Barrier (seat only, per unit)	\$89			

All shipments for this series will be blanket-wrapped as standard. For customers located in Territory 1 who require cartoning, a 5% upcharge will be added to each product. Please contact client services for additional information.

SUITE GUEST + TANDEM | Designed by David Dahl

ORDERING REQUIREMENTS:

- Model number
- Top surface
- Top finish, as applicable
- Frame finish, as applicable
- Options, as applicable

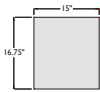
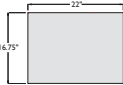
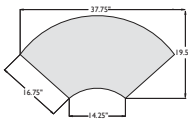
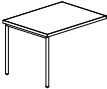
MODEL	PRODUCT SPECIFICATIONS	WOOD (-W) OR LAMINATE TOP (-L)	SOLID SURFACE TOP (-SF)	WEIGHT
7540-15- () 	15" Wide Center Table 15" W x 16.75" D	661	807	2 lbs.
7540-22- () 	22" Wide Center Table 22" W x 16.75" D	749	961	3 lbs.
7540-90- () 	90-Degree Corner Table 37.75" W x 19.5" D	809	1,288	6 lbs.
7540-ET- () 	22" Wide End Table 22" W x 16.75" D	854	1,066	55 lbs.

OPTIONS

- SM04 Super Matte Sable Wood Finish \$46
- VCT02 VCT Tile Glides (end table) \$14

SUITE GUEST + TANDEM | Designed by David Dahl

TANDEM CONFIGURATIONS & ORDERING EXAMPLES:



Qty	Model #	Description	COM List
2	7540-ET-W	22" Wide End Table, Wood Top (\$854 List each)	\$1,708
1	7520-ST-W	Tandem Starter Unit, Wood Arm Caps	\$1,561
2	7520-AO-W	Tandem Add-On Unit, Wood Arm Caps (\$1,398 List each)	\$2,796
1	7520-EU-W	Tandem End Unit, Wood Arm Caps	\$1,381
			\$7,446



Qty	Model #	Description	COM List
1	7522-U	Tandem Two-Seater, Black Urethane Arm Caps	\$2,835
1	7540-15-SF	15" Wide Inline Table, Solid Surface Top	\$807
1	7523-U	Tandem Three-Seater, Black Urethane Arm Caps	\$4,181
			\$7,823



Qty	Model #	Description	COM List
1	7550-ST-W	Bariatric Starter Unit, Wood Arm Caps	\$1,870
1	7520-AO-W	Tandem Add-On Unit, Wood Arm Caps	\$1,398
2	7520-EU-W	Tandem End Unit, Wood Arm Caps (\$1,381 List each)	\$2,762
1	7540-90-L	90-Degree Connecting Table, Laminate Top	\$809
1	7520-ST-W	Tandem Starter Unit, Wood Arm Caps	\$1,561
1	7550-AO-W	Bariatric Add-On Unit, Wood Arm Caps	\$1,716
			\$10,116

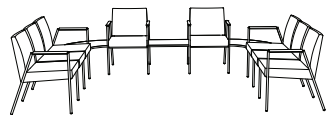





Qty	Model #	Description	COM List
2	7535-ST-W	Tandem Starter Unit, Wood Arm Cap/Armless (\$1,468 List each)	\$2,936
2	7530-AO	Tandem Add-On Unit, Armless (\$1,320 List each)	\$2,640
2	7535-EU-W	Tandem End Unit, Armless/Wood Arm Cap (\$1,379 List each)	\$2,758
2	7540-90-W	90-Degree Connecting Table, Wood Top (\$809 List each)	\$1,618
2	7521-W	Single Chair, Wood Arm Caps (\$1,564 List each)	\$3,128
1	7540-22-W	22" Wide Inline Table, Wood Top	\$749
			\$13,829

All shipments for this series will be blanket-wrapped as standard. For customers located in Territory 1 who require cartoning, a 5% upcharge will be added to each product. Please contact client services for additional information.

SUITE GUEST + TANDEM | Designed by David Dahl

PRODUCT FEATURES:

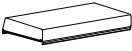
- Concealed velcro attachment.
- Replacement seat and back covers can be easily field installed on previously ordered Suite models with replaceable cover option.
- Suite models originally ordered with standard fixed upholstery can utilize replacement seat and/or back covers; however, some upholstery work will be required to remove original upholstery covers.









MODEL	PRODUCT SPECIFICATIONS	FABRIC GRADES										LEATHER	
		COM	A	1	2	3	4	COL 5	6	7	8	L1	L2
RSC-7515	 <p>Guest/Tandem Replacement Upholstered Seat Cover COM: .75 yd. COL: 15 sq. ft.</p>	218	266	293	308	333	360	384	410	434	460	578	664
RBC-7515	 <p>Guest/Tandem Replacement Upholstered Back Cover COM: .75 yd. COL: 15 sq. ft.</p>	218	266	293	308	333	360	384	410	434	460	578	664
RSC-7550	 <p>Bariatric Replacement Upholstered Seat Cover COM: 1 yd. COL: 20 sq. ft.</p>	271	335	370	391	424	460	492	526	559	593	751	865
RBC-7550	 <p>Bariatric Replacement Upholstered Back Cover COM: 1 yd. COL: 20 sq. ft.</p>	271	335	370	391	424	460	492	526	559	593	751	865

All shipments for this series will be blanket-wrapped as standard. For customers located in Territory 1 who require cartoning, a 5% upcharge will be added to each product. Please contact client services for additional information.

SUITE GUEST + TANDEM | Designed by David Dahl

PRODUCT FEATURES:

- Replacement hardware included with replacement arms and/or arm caps.
- Please specify frame finish and/or wood arm cap finish as applicable.

MODEL	PRODUCT SPECIFICATIONS	LIST
 7500-AR (Right Arm, As Seated)	Replacement Arm, No Arm Cap Guest/Tandem/Bariatric Models Weight: 4 lbs.	194
 7500-AC (Center Arm, As Seated)	Replacement Arm, No Arm Cap Guest/Tandem/Bariatric Models Weight: 4 lbs.	227
 7500-AL (Left Arm, As Seated)	Replacement Arm, No Arm Cap Guest/Tandem/Bariatric Models Weight: 4 lbs.	194
 7505-AR (Right Side, As Seated)	Replacement Frame Armless Guest/Tandem Models Weight: 3 lbs.	147
 7505-AC (Center, As Seated)	Replacement Frame Armless Guest/Tandem Models Weight: 3 lbs.	185
 7505-AL (Left Side, As Seated)	Replacement Frame Armless Guest/Tandem Models Weight: 3 lbs.	147
 7507-U (Black Urethane)	Replacement Black Urethane Arm Cap Guest/Tandem/Bariatric Models Weight: .5 lb.	56
 7507-W (Wood)	Replacement Wood Arm Cap Guest/Tandem/Bariatric Models Weight: .5 lb.	75
 7507-SF (Solid Surface)	Replacement Solid Surface Arm Cap Guest/Tandem/Bariatric Models Weight: 1 lb.	162

OPTIONS

-SM01 Super Matte Sable Wood Finish (per arm cap) \$12

SUITE GUEST + TANDEM | Designed by David Dahl

UPHOLSTERY COMBINATIONS:

- For upholstery combinations, refer to the pricing below.
- When combining two COM/COV/COL fabrics, or fabrics with the same grade, add \$120 List per unit.
- When combining three or more COM/COV/COL fabrics, or fabrics with the same grade, add \$150 List per unit.
- When combining different grades of fabric, price will be based on the highest grade specified.
- Two-tone upholstery examples and yardage requirements for the most common combinations are listed below. Additional combinations available; please contact client services for yardage requirements and pricing.
- Note: Yardage amounts are based on fabric which is plain (i.e. non-directional) and a full 54" wide.
- Appropriate upholstery code must be included.



Code

Model

All Single Guest
and Tandem Units

SS1

COM Requirement

Back = .75 yd.
Balance of Chair = .75 yd.



Code

Model

All Single Guest
and Tandem Units

SS2

COM Requirement

Inside Back/Top of Seat = 1.25 yds.
Balance of Chair = .75 yd.

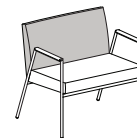

Code

Model

All Bariatric Units

SS3

COM Requirement

Back = 1.25 yds.
Balance of Chair = 1 yd.



Code

Model

All Bariatric Units

SS4

COM Requirement

Inside Back/Top of Seat = 1.5 yds.
Balance of Chair = 1 yd.

All shipments for this series will be blanket-wrapped as standard. For customers located in Territory 1 who require cartoning, a 5% upcharge will be added to each product. Please contact client services for additional information.

SUNNY GUEST | Designed by Rainlight



SPECIFICATIONS:

- Guest and settee models with wood frame.
- Wood frame manufactured in Ash and features die-cast aluminum connectors.
- Offered in all standard and custom wood finishes on Ash.
- For Super Matte Sable Ash finish, upcharge applies. Refer to option section for pricing.
- For custom wood finishes, please add \$531 List per color per order.
- Die-cast aluminum connectors available in standard and premium finishes. See below for options.
- For custom finish colors, please contact client services for pricing.
- Guest chair features 275 lb. weight capacity; settee features 325 lb. weight capacity.
- All dimensions are nominal.
- Refer to terms and conditions for general information regarding fabrics, finishes, warranty, freight, complete condition of sales and more.

STANDARD METAL CONNECTOR FINISH COLORS:

- 0405 Charcoal Grey
- 0535 Metallic Silver
- 0630 Satin Black

PREMIUM METAL CONNECTOR FINISH COLORS:



- 0605 Matte Black
- 0705 Matte Cotton
- 0788 Glossy Cotton
- 0805 Oasis
- 0905 Mint
- 1005 Mercury
- 1105 Canary
- 1205 Stone
- 1305 Sage
- 1405 Ice Blue
- 1505 Clay

All shipments for this series will be blanket-wrapped as standard. For customers located in Territory 1 who require cartoning, a 5% upcharge will be added to each product. Please contact client services for additional information.

SUNNY GUEST | Designed by Rainlight

ORDERING REQUIREMENTS:

- Model number
- Frame finish
- Aluminum connector finish
- Upholstery selection
- Options, as applicable

MODEL	PRODUCT SPECIFICATIONS	FABRIC GRADES								LEATHER			
		COM	A	1	2	3	4	COL 5	6	7	8	L1	L2
8310 	Guest Chair 20.5" W x 24.5" D x 30.5" H Seat: 20.5" W x 18" D Seat Ht: 18" COM: 1.25 yds. COL: 25 sq. ft. 17.5 lbs.	1,722	1,802	1,846	1,872	1,914	1,959	1,999	2,041	2,082	2,125	2,322	2,465
8311 	Settee 40.25" W x 24.75" D x 30.25" H Seat: 40.25" W x 18.25" D Seat Ht: 18" COM: 2.25 yds. COL: 45 sq. ft. 35 lbs.	1,991	2,135	2,214	2,261	2,336	2,417	2,489	2,565	2,639	2,716	3,071	3,328

OPTIONS

-PF01	Premium Aluminum Connector Finish	\$71
-SM03	Super Matte Sable Wood Finish	\$34
-FG04	Felt Glides	\$26
-NS04	Non-Skid Glides	\$26

SUNNY GUEST | Designed by Rainlight

UPHOLSTERY COMBINATIONS:

- For upholstery combinations, refer to the pricing below.
- When combining two COM/COV/COL fabrics, or fabrics with the same grade, add \$120 List per unit.
- When combining three or more COM/COV/COL fabrics, or fabrics with the same grade, add \$150 List per unit.
- When combining different grades of fabric, price will be based on the highest grade specified.
- Two-tone upholstery examples and yardage requirements for the most common combinations are listed below. Additional combinations available; please contact client services for yardage requirements and pricing.
- Note: Yardage amounts are based on fabric which is plain (i.e. non-directional) and a full 54" wide.
- Appropriate upholstery code must be included.



Code **SG1**
Model COM Requirement
8310 Seat = .75 yd.
 Back = .75 yd.



Code **SG2**
Model COM Requirement
8310 Outer Edge Band (Back & Seat) = .75 yd.
 Balance of Chair = 1 yd.



Code **SS1**
Model COM Requirement
8311 Seat = 1.25 yds.
 Back = 1.25 yds.



Code **SS2**
Model COM Requirement
8311 Outer Edge Band (Back & Seat) = 1 yd.
 Balance of Chair = 1.5 yds.

All shipments for this series will be blanket-wrapped as standard. For customers located in Territory 1 who require cartoning, a 5% upcharge will be added to each product. Please contact client services for additional information.

SUNNY LOUNGE | Designed by Rainlight



SPECIFICATIONS:

- Wood frame manufactured in Ash and features die-cast aluminum connectors.
- Offered in all standard and custom wood finishes on Ash.
- For Super Matte Sable Ash finish, upcharge applies. Refer to option section for pricing.
- For custom wood finishes, please add \$531 List per color per order.
- Die-cast aluminum connectors available in standard and premium finishes. See below for options.
- For custom finish colors, please contact client services for pricing.
- 275 lb. weight capacity.
- All dimensions are nominal.
- Refer to terms and conditions for general information regarding fabrics, finishes, warranty, freight, complete condition of sales and more.

STANDARD METAL CONNECTOR FINISH COLORS:

- 0405 Charcoal Grey
- 0535 Metallic Silver
- 0630 Satin Black

PREMIUM METAL CONNECTOR FINISH COLORS:

- 0605 Matte Black
- 0705 Matte Cotton
- 0788 Glossy Cotton
- 0805 Oasis
- 0905 Mint
- 1005 Mercury
- 1105 Canary
- 1205 Stone
- 1305 Sage
- 1405 Ice Blue
- 1505 Clay

All shipments for this series will be blanket-wrapped as standard. For customers located in Territory 1 who require cartoning, a 5% upcharge will be added to each product. Please contact client services for additional information.

SUNNY LOUNGE | Designed by Rainlight

ORDERING REQUIREMENTS:

- Model number
- Frame finish
- Aluminum connector finish
- Upholstery selection
- Options, as applicable

MODEL	PRODUCT SPECIFICATIONS	FABRIC GRADES								LEATHER			
		COM	A	1	2	3	4	COL 5	6	7	8	L1	L2
8320 	Lounge Chair 21.75" W x 25.75" D x 27.5" H Seat: 21.75" W x 20.5" D Seat Ht: 16.25" COM: 1.5 yds. COL: 30 sq. ft. 19.5 lbs.	1,849	1,945	1,998	2,029	2,079	2,133	2,181	2,232	2,281	2,332	2,569	2,740

OPTIONS

-PF01	Premium Aluminum Connector Finish	\$71
-SM03	Super Matte Sable Wood Finish	\$34
-FG04	Felt Glides	\$26
-NS04	Non-Skid Glides	\$26

SUNNY LOUNGE | Designed by Rainlight

UPHOLSTERY COMBINATIONS:

- For upholstery combinations, refer to the pricing below.
- When combining two COM/COV/COL fabrics, or fabrics with the same grade, add \$120 List per unit.
- When combining three or more COM/COV/COL fabrics, or fabrics with the same grade, add \$150 List per unit.
- When combining different grades of fabric, price will be based on the highest grade specified.
- Two-tone upholstery examples and yardage requirements for the most common combinations are listed below. Additional combinations available; please contact client services for yardage requirements and pricing.
- Note: Yardage amounts are based on fabric which is plain (i.e. non-directional) and a full 54" wide.
- Appropriate upholstery code must be included.



Code	SL1
<u>Model</u>	<u>COM Requirement</u>
8320	Seat = 1 yd. Back = .75 yd.



Code	SL2
<u>Model</u>	<u>COM Requirement</u>
8320	Outer Edge Band (Back & Seat) = .75 yd. Balance of Chair = 1 yd.

All shipments for this series will be blanket-wrapped as standard. For customers located in Territory 1 who require cartoning, a 5% upcharge will be added to each product. Please contact client services for additional information.

SUNNY OCCASIONAL TABLES | Designed by Rainlight

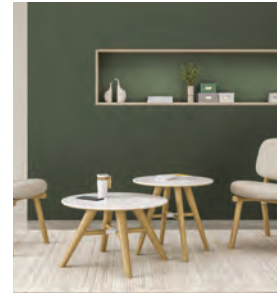

SPECIFICATIONS:

- Round and oval top shapes.
- Two heights: 16" and 18".
- Four top surface options: wood veneer, laminate, Fenix® and solid surface.
- Wood veneer tops and wood base available in all standard and custom finishes on Ash.
- For Super Matte Sable Ash finish, upcharge applies. Refer to option section for pricing.
- For custom wood finishes, please contact client services and add one-time upcharge of \$531 List per color per order.
- For custom laminate options, add \$649 List per color per order. Pre-approval required, please contact client services.
- Fenix offered in five standard colorways.
- For non-standard Fenix colors, please contact client services for pricing.
- For veneer, standard wood grain and solid black laminate, as well as Fenix Nero Ingo (black), edge will match top finish color, unless specified otherwise.
- For all other solid color laminate and Fenix tops, edge to match specified leg finish.
- Solid surface available in white only with exposed plywood clear coat edge.
- Die-cast aluminum connectors available in standard and premium finishes. See below for options
- For custom finish colors, please contact client services for pricing.
- All dimensions are nominal.
- Refer to terms and conditions for general information regarding finishes, warranty, freight, complete condition of sales and more.

EDGE DETAIL:

Laminate*/Veneer/Fenix Top



Solid Surface Top



*Please note that laminate thickness is nominal and may vary.

STANDARD METAL CONNECTOR FINISH COLORS:

- 0405 Charcoal Grey
- 0535 Metallic Silver
- 0630 Satin Black

PREMIUM METAL CONNECTOR FINISH COLORS:



- 0605 Matte Black
- 0705 Matte Cotton
- 0788 Glossy Cotton
- 0805 Oasis
- 0905 Mint
- 1005 Mercury
- 1105 Canary
- 1205 Stone
- 1305 Sage
- 1405 Ice Blue
- 1505 Clay

All shipments for this series will be blanket-wrapped as standard. For customers located in Territory 1 who require cartoning, a 5% upcharge will be added to each product. Please contact client services for additional information.

SUNNY OCCASIONAL TABLES | Designed by Rainlight

ORDERING REQUIREMENTS:

- Model number
- Top surface
- Top finish, if applicable
- Base finish
- Aluminum connector finish
- Options, as applicable

	MODEL	DIMENSIONS	VENEER TOP (-V) LAMINATE TOP (-L)	FENIX TOP (-FE)	SOLID SURFACE TOP (-SF)	WEIGHT
	Round Table					
	8300-2018-()	20" Dia x 18" H	1,309	1,431	1,544	13.5 lbs.
	8300-3016-()	30" Dia x 16" H	1,584	1,858	2,063	18.5 lbs.
	8300-3616-()	36" Dia x 16" H	1,827	2,222	2,760	21.5 lbs.
	Oval Table					
	8300-482216-()	48" W x 22" D x 16" H	1,893	2,215	2,722	23.5 lbs.

OPTIONS

-PF01	Premium Aluminum Connector Finish	\$71
-SMO4	Super Matte Sable Wood Finish	\$46
-FG04	Felt Glides	\$26
-NS04	Non-Skid Glides	\$26

TWIRL® GUEST | Designed by Chris & Jon Panichella



SPECIFICATIONS:

- Fully upholstered and wood back shell models available.
- Wood back shell models feature upholstered back cushion and fully upholstered seat.
- Wood back shell models feature exposed plywood edge.
- Edge finish on wood back shell models will match veneer finish as standard.
- Four base options: 4-leg metal, metal swivel, 4-leg wood and wood swivel.
- Swivel base models feature self-return.
- Metal bases available in standard and premium finishes.
- For custom metal finish colors, please contact client services for pricing.
- Wood offered in all standard and custom finishes on Ash.
- For Super Matte Sable Ash finish, upcharge applies. Refer to option section for pricing.
- For custom wood finishes, please contact client services and add one-time upcharge of \$531 List per color per order.
- 300 lb. weight capacity.
- All dimensions are nominal.
- Refer to terms and conditions for general information regarding fabrics, finishes, warranty, freight, complete condition of sales and more.

STANDARD METAL BASE FINISH COLORS:

- 0405 Charcoal Grey
- 0535 Metallic Silver
- 0199 Chrome (4-leg base only)
- 0299 Polished Aluminum (swivel base only)
- 0630 Satin Black

PREMIUM METAL BASE FINISH COLORS:





- 0605 Matte Black
- 0705 Matte Cotton
- 0788 Glossy Cotton
- 0805 Oasis
- 0905 Mint
- 1005 Mercury
- 1105 Canary
- 1205 Stone
- 1305 Sage
- 1405 Ice Blue
- 1505 Clay

All shipments for this series will be blanket-wrapped as standard. For customers located in Territory 1 who require cartoning, a 5% upcharge will be added to each product. Please contact client services for additional information.

TWIRL® GUEST | Designed by Chris & Jon Panichella

ORDERING REQUIREMENTS:

- Model number
- Wood back finish
- Base finish
- Upholstery selection
- Options, as applicable

MODEL	PRODUCT SPECIFICATIONS	FABRIC GRADES										LEATHER	
		COM	A	1	2	3	4	COL 5	6	7	8	L1	L2
60121-W 	Guest Chair, 4-Leg Metal Base Wood Back with Upholstered Cushion 24.5" W x 23.5" D x 30" H Seat: 18" W x 18" D Seat Ht: 19" COM: 2 yds. COL: 40 sq. ft. 23 lbs.	1,540	1,668	1,738	1,780	1,846	1,918	1,982	2,050	2,116	2,184	2,500	2,728
60123-W 	Guest Chair, Metal Swivel Base Wood Back with Upholstered Cushion 23.5" W x 23" D x 29.5" H Seat: 18" W x 18" D Seat Ht: 18.5" COM: 2 yds. COL: 40 sq. ft. 25 lbs.	1,686	1,814	1,884	1,926	1,992	2,064	2,128	2,196	2,262	2,330	2,646	2,874
60124-W 	Guest Chair, 4-Leg Wood Base Wood Back with Upholstered Cushion 23.5" W x 25" D x 29.5" H Seat: 18" W x 18" D Seat Ht: 18.5" COM: 2 yds. COL: 40 sq. ft. 24 lbs.	1,556	1,684	1,754	1,796	1,862	1,934	1,998	2,066	2,132	2,200	2,516	2,744
60127-W 	Guest Chair, Wood Swivel Base Wood Back with Upholstered Cushion 23.5" W x 24" D x 29.5" H Seat: 18" W x 18" D Seat Ht: 18.5" COM: 2 yds. COL: 40 sq. ft. 27 lbs.	1,876	2,004	2,074	2,116	2,182	2,254	2,318	2,386	2,452	2,520	2,836	3,064

OPTIONS

-PF02	Premium Metal Base Finish	\$101
-SM03	Super Matte Sable Wood Finish (wood back only)	\$34
-SM04	Super Matte Sable Wood Finish (wood back and base)	\$46
-NS04	Non-Skid Glides (4-leg models only)	\$26
-NS04	Non-Skid Glides (swivel base models only)	\$26
-CO2	Casters (metal swivel base models only)*	\$70





*Caster models feature 5-star base with swivel mechanism. Please apply upcharge to corresponding metal swivel base List price.

All shipments for this series will be blanket-wrapped as standard. For customers located in Territory 1 who require cartoning, a 5% upcharge will be added to each product. Please contact client services for additional information.

TWIRL® GUEST | Designed by Chris & Jon Panichella

ORDERING REQUIREMENTS:

- Model number
- Base finish
- Upholstery selection
- Options, as applicable

MODEL	PRODUCT SPECIFICATIONS	FABRIC GRADES										LEATHER	
		COM	A	1	2	3	4	COL 5	6	7	8	L1	L2
60121-U 	Guest Chair, 4-Leg Metal Base Fully Upholstered 25" W x 24" D x 30.5" H Seat: 18" W x 18" D Seat Ht: 19" COM: 2.25 yds. COL: 45 sq. ft. 25 lbs.	1,560	1,704	1,783	1,830	1,905	1,986	2,058	2,134	2,208	2,285	2,640	2,897
60123-U 	Guest Chair, Metal Swivel Base Fully Upholstered 24" W x 23.5" D x 30" H Seat: 18" W x 18" D Seat Ht: 18.5" COM: 2.25 yds. COL: 45 sq. ft. 27 lbs.	1,703	1,847	1,926	1,973	2,048	2,129	2,201	2,277	2,351	2,428	2,783	3,040
60124-U 	Guest Chair, 4-Leg Wood Base Fully Upholstered 24" W x 25.5" D x 30" H Seat: 18" W x 18" D Seat Ht: 18.5" COM: 2.25 yds. COL: 45 sq. ft. 26 lbs.	1,557	1,701	1,780	1,827	1,902	1,983	2,055	2,131	2,205	2,282	2,637	2,894
60127-U 	Guest Chair, Wood Swivel Base Fully Upholstered 24" W x 24.5" D x 30" H Seat: 18" W x 18" D Seat Ht: 18.5" COM: 2.25 yds. COL: 45 sq. ft. 29 lbs.	1,887	2,031	2,110	2,157	2,232	2,313	2,385	2,461	2,535	2,612	2,967	3,224

OPTIONS

-PF02	Premium Metal Base Finish	\$101
-SM02	Super Matte Sable Wood Finish	\$23
-NS04	Non-Skid Glides (4-leg models only)	\$26
-NS04	Non-Skid Glides (swivel base models only)	\$26
-C02	Casters (metal swivel base models only)*	\$70

*Caster models feature 5-star base with swivel mechanism. Please apply upcharge to corresponding metal swivel base List price.

TWIRL® GUEST | Designed by Chris & Jon Panichella

UPHOLSTERY COMBINATIONS:

- For upholstery combinations, refer to the pricing below.
- When combining two COM/COV/COL fabrics, or fabrics with the same grade, add \$120 List per unit.
- When combining three or more COM/COV/COL fabrics, or fabrics with the same grade, add \$150 List per unit.
- When combining different grades of fabric, price will be based on the highest grade specified.
- Two-tone upholstery examples and yardage requirements for the most common combinations are listed below. Additional combinations available; please contact client services for yardage requirements and pricing.
- Note: Yardage amounts are based on fabric which is plain (i.e. non-directional) and a full 54" wide.
- Appropriate upholstery code must be included.



Code

Model

60121-U
60123-U
60124-U
60127-U

TW1

COM Requirement

Back Shell = 1.75 yds.
Balance of Chair = 1.25 yds.



Code

Model

60121-U
60123-U
60124-U
60127-U

TW2

COM Requirement

Back Shell & Seat Cushion = 2.5 yds.
Lower Side Panels = 1 yd.



Code

Model

60121-U
60123-U
60124-U
60127-U

TW3

COM Requirement

Back Shell & Lower Side Panels = 1.75 yds.
Seat Cushion = .75 yd.



Code

Model

60121-U
60123-U
60124-U
60127-U

TW4

COM Requirement

Inside Back Cushion & Seat Cushion = 1.5 yds.
Balance of Chair = 1.5 yds.



Code

Model

60121-W
60123-W
60124-W
60127-W

TW5

COM Requirement

Inside Back Cushion = 1 yd.
Balance of Chair = 1.25 yds.



Code

Model

60121-W
60123-W
60124-W
60127-W

TW6

COM Requirement

Inside Back Cushion & Seat Cushion = 1.5 yds.
Lower Side Panels = 1 yd.



Code

Model

60121-W
60123-W
60124-W
60127-W

TW7

COM Requirement

Inside Back Cushion & Lower Side Panels = 1.75 yds.
Seat Cushion = .75 yd.

All shipments for this series will be blanket-wrapped as standard. For customers located in Territory 1 who require cartoning, a 5% upcharge will be added to each product. Please contact client services for additional information.

TWIRL® LOUNGE | Designed by Chris & Jon Panichella



SPECIFICATIONS:

- Mid- and high back models available fully upholstered or with wood back shell.
- Wood back shell models feature upholstered back cushion and fully upholstered seat.
- Exposed plywood edge featured on wood back shell models.
- Edge finish on wood back shell models will match veneer finish as standard.
- Three base options: metal swivel, 4-leg wood and wood swivel.
- Swivel base models feature self-return.
- Metal swivel base offered in standard and premium finishes. See below for options.
- For custom metal finish colors, please contact client services for pricing.
- Wood offered in all standard and custom finishes on Ash.
- For Super Matte Sable Ash finish, upcharge applies. Refer to option section for pricing.
- For custom wood finishes, please contact client services and add one-time upcharge of \$531 List per color per order.
- 300 lb. weight capacity.
- All dimensions are nominal.
- Refer to terms and conditions for general information regarding fabrics, finishes, warranty, freight, complete condition of sales and more.

STANDARD METAL BASE FINISH COLORS:

- 0405 Charcoal Grey
- 0535 Metallic Silver
- 0299 Polished Aluminum
- 0630 Satin Black

PREMIUM METAL BASE FINISH COLORS:



- 0605 Matte Black
- 0705 Matte Cotton
- 0788 Glossy Cotton
- 0805 Oasis
- 0905 Mint
- 1005 Mercury
- 1105 Canary
- 1205 Stone
- 1305 Sage
- 1405 Ice Blue
- 1505 Clay

All shipments for this series will be blanket-wrapped as standard. For customers located in Territory 1 who require cartoning, a 5% upcharge will be added to each product. Please contact client services for additional information.

TWIRL® LOUNGE | Designed by Chris & Jon Panichella

ORDERING REQUIREMENTS:

- Model number
- Wood finish
- Base finish
- Upholstery selection
- Options, as applicable

MODEL	PRODUCT SPECIFICATIONS	FABRIC GRADES										LEATHER	
		COM	A	1	2	3	4	COL 5	6	7	8	L1	L2
60223-M-W 	Mid-Back Lounge Chair, Metal Swivel Base, Wood Back with Upholstered Cushion 29" W x 29.5" D x 32.75" H Seat: 19" W x 19" D Seat Ht: 16.5" COM: 2.5 yds. COL: 50 sq. ft. 35 lbs.	2,392	2,552	2,640	2,692	2,775	2,865	2,945	3,030	3,112	3,197	3,592	3,877
60224-M-W 	Mid-Back Lounge Chair, 4-Leg Wood Base, Wood Back with Upholstered Cushion 29" W x 28.5" D x 32.75" H Seat: 19" W x 19" D Seat Ht: 16.5" COM: 2.5 yds. COL: 50 sq. ft. 34 lbs.	2,475	2,635	2,723	2,775	2,858	2,948	3,028	3,113	3,195	3,280	3,675	3,960
60227-M-W 	Mid-Back Lounge Chair, Wood Swivel Base, Wood Back with Upholstered Cushion 29" W x 28.5" D x 32.75" H Seat: 19" W x 19" D Seat Ht: 16.5" COM: 2.5 yds. COL: 50 sq. ft. 37 lbs.	2,662	2,822	2,910	2,962	3,045	3,135	3,215	3,300	3,382	3,467	3,862	4,147

OPTIONS



-PF02	Premium Metal Base Finish	\$101
-SM03	Super Matte Sable Wood Finish (wood back only)	\$34
-SM04	Super Matte Sable Wood Finish (wood back and base)	\$46
-NS04	Non-Skid Glides	\$26

All shipments for this series will be blanket-wrapped as standard. For customers located in Territory 1 who require cartoning, a 5% upcharge will be added to each product. Please contact client services for additional information.

TWIRL® LOUNGE | Designed by Chris & Jon Panichella

ORDERING REQUIREMENTS:

- Model number
- Wood finish
- Base finish
- Upholstery selection
- Options, as applicable

MODEL	PRODUCT SPECIFICATIONS	FABRIC GRADES								LEATHER			
		COM	A	1	2	3	4	COL 5	6	7	8	L1	L2
60223-H-W 	High Back Lounge Chair, Metal Swivel Base, Wood Back with Upholstered Cushion 29" W x 32.25" D x 38.75" H Seat: 19" W x 19" D Seat Ht: 16.5" COM: 2.75 yds. COL: 55 sq. ft. 37 lbs.	2,564	2,740	2,837	2,894	2,985	3,084	3,172	3,266	3,356	3,450	3,884	4,198
60224-H-W 	High Back Lounge Chair, 4-Leg Wood Base, Wood Back with Upholstered Cushion 29" W x 31.25" D x 38.75" H Seat: 19" W x 19" D Seat Ht: 16.5" COM: 2.75 yds. COL: 55 sq. ft. 36 lbs.	2,644	2,820	2,917	2,974	3,065	3,164	3,252	3,346	3,436	3,530	3,964	4,278
60227-H-W 	High Back Lounge Chair, Wood Swivel Base, Wood Back with Upholstered Cushion 29" W x 31.25" D x 38.75" H Seat: 19" W x 19" D Seat Ht: 16.5" COM: 2.75 yds. COL: 55 sq. ft. 39 lbs.	2,832	3,008	3,105	3,162	3,253	3,352	3,440	3,534	3,624	3,718	4,152	4,466

OPTIONS



-PF02	Premium Metal Base Finish	\$101
-SM03	Super Matte Sable Wood Finish (wood back only)	\$34
-SM04	Super Matte Sable Wood Finish (wood back and base)	\$46
-NS04	Non-Skid Glides	\$26

All shipments for this series will be blanket-wrapped as standard. For customers located in Territory 1 who require cartoning, a 5% upcharge will be added to each product. Please contact client services for additional information.

TWIRL® LOUNGE | Designed by Chris & Jon Panichella

ORDERING REQUIREMENTS:

- Model number
- Base finish
- Upholstery selection
- Options, as applicable

MODEL	PRODUCT SPECIFICATIONS	FABRIC GRADES										LEATHER	
		COM	A	1	2	3	4	COL 5	6	7	8	L1	L2
60223-M-U 	Mid-Back Lounge Chair, Metal Swivel Base, Fully Upholstered 29.5" W x 29.75" D x 33" H Seat: 19" W x 19" D Seat Ht: 16.5" COM: 3 yds. COL: 60 sq. ft. 35 lbs.	2,258	2,450	2,555	2,618	2,717	2,825	2,921	3,023	3,122	3,224	3,698	4,040
60224-M-U 	Mid-Back Lounge Chair, 4-Leg Wood Base, Fully Upholstered 29.5" W x 28.75" D x 33" H Seat: 19" W x 19" D Seat Ht: 16.5" COM: 3 yds. COL: 60 sq. ft. 34 lbs	2,299	2,491	2,596	2,659	2,758	2,866	2,962	3,064	3,163	3,265	3,739	4,081
60227-M-U 	Mid-Back Lounge Chair, Wood Swivel Base, Fully Upholstered 29.5" W x 28.75" D x 33" H Seat: 19" W x 19" D Seat Ht: 16.5" COM: 3 yds. COL: 60 sq. ft. 37 lbs.	2,485	2,677	2,782	2,845	2,944	3,052	3,148	3,250	3,349	3,451	3,925	4,267

OPTIONS



-PF02	Premium Metal Base Finish	\$101
-SM02	Super Matte Sable Wood Finish	\$23
-NS04	Non-Skid Glides	\$26

All shipments for this series will be blanket-wrapped as standard. For customers located in Territory 1 who require cartoning, a 5% upcharge will be added to each product. Please contact client services for additional information.

TWIRL® LOUNGE | Designed by Chris & Jon Panichella

ORDERING REQUIREMENTS:

- Model number
- Base finish
- Upholstery selection
- Options, as applicable

MODEL	PRODUCT SPECIFICATIONS	FABRIC GRADES								LEATHER			
		COM	A	1	2	3	4	COL 5	6	7	8	L1	L2
60223-H-U 	High Back Lounge Chair, Metal Swivel Base, Fully Upholstered 29.5" W x 33" D x 39" H Seat: 19" W x 19" D Seat Ht: 16.5" COM: 3.5 yds. COL: 70 sq. ft. 37 lbs.	2,354	2,578	2,701	2,774	2,890	3,016	3,128	3,247	3,362	3,481	4,034	4,433
60224-H-U 	High Back Lounge Chair, 4-Leg Wood Base, Fully Upholstered 29.5" W x 32" D x 39" H Seat: 19" W x 19" D Seat Ht: 16.5" COM: 3.5 yds. COL: 70 sq. ft. 36 lbs.	2,436	2,660	2,783	2,856	2,972	3,098	3,210	3,329	3,444	3,563	4,116	4,515
60227-H-U 	High Back Lounge Chair, Wood Swivel Base, Fully Upholstered 29.5" W x 32" D x 39" H Seat: 19" W x 19" D Seat Ht: 16.5" COM: 3.5 yds. COL: 70 sq. ft. 39 lbs.	2,623	2,847	2,970	3,043	3,159	3,285	3,397	3,516	3,631	3,750	4,303	4,702

OPTIONS

-PF02	Premium Metal Base Finish	\$101
-SM02	Super Matte Sable Wood Finish	\$23
-NS04	Non-Skid Glides	\$26

TWIRL® LOUNGE | Designed by Chris & Jon Panichella

UPHOLSTERY COMBINATIONS:

- For upholstery combinations, refer to the pricing below.
- When combining two COM/COV/COL fabrics, or fabrics with the same grade, add \$120 List per unit.
- When combining three or more COM/COV/COL fabrics, or fabrics with the same grade, add \$150 List per unit.
- When combining different grades of fabric, price will be based on the highest grade specified.
- Two-tone upholstery examples and yardage requirements for the most common combinations are listed below. Additional combinations available; please contact client services for yardage requirements and pricing.
- Note: Yardage amounts are based on fabric which is plain (i.e. non-directional) and a full 54" wide.
- Appropriate upholstery code must be included.



Code

Model

60223-M-U
60224-M-U
60227-M-U

TW8

COM Requirement

Back Shell = 1.5 yds.
Balance of Chair = 1.75 yds.



Code

Model

60223-M-U
60224-M-U
60227-M-U

TW9

COM Requirement

Back Shell & Seat Cushion = 2.5 yds.
Lower Side Panels = 1.25 yds.



Code

Model

60223-M-U
60224-M-U
60227-M-U

TW10

COM Requirement

Back Shell & Lower Side Panels = 2.5 yds.
Seat Cushion = .75 yd.



Code

Model

60223_M-U
60224-M-U
60227-M-U

TW11

COM Requirement

Inside Back Cushion & Seat Cushion = 1.5 yds.
Balance of Chair = 1.5 yds.

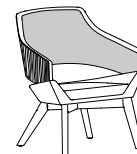

Code

Model

60223-M-W
60224-M-W
60227-M-W

TW12

COM Requirement

Inside Back Cushion = 1 yd.
Balance of Chair = 1.75 yds.



Code

Model

60223-M-W
60224-M-W
60227-M-W

TW13

COM Requirement

Inside Back Cushion & Seat Cushion = 1.5 yds.
Lower Side Panels = 2 yds.



Code

Model

60223-M-W
60224-M-W
60227-M-W

TW14

COM Requirement

Inside Back Cushion & Lower Side Panels = 2 yds.
Seat Cushion = .75 yd.

TWIRL® LOUNGE | Designed by Chris & Jon Panichella

UPHOLSTERY COMBINATIONS:

- For upholstery combinations, refer to the pricing below.
- When combining two COM/COV/COL fabrics, or fabrics with the same grade, add \$120 List per unit.
- When combining three or more COM/COV/COL fabrics, or fabrics with the same grade, add \$150 List per unit.
- When combining different grades of fabric, price will be based on the highest grade specified.
- Two-tone upholstery examples and yardage requirements for the most common combinations are listed below. Additional combinations available; please contact client services for yardage requirements and pricing.
- Note: Yardage amounts are based on fabric which is plain (i.e. non-directional) and a full 54" wide.
- Appropriate upholstery code must be included.

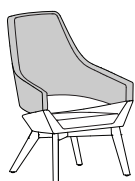

Code
Model
60223-H-U
60224-H-U
60227-H-U

TW15
COM Requirement
Back Shell = 1.75 yd.
Balance of Chair = 1.75 yds.

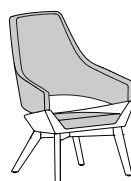

Code
Model
60223-H-U
60224-H-U
60227-H-U

TW16
COM Requirement
Back Shell & Seat Cushion = 2.75 yds.
Lower Side Panels = 1.25 yds.

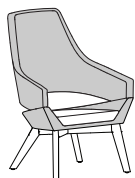

Code
Model
60223-H-U
60224-H-U
60227-H-U

TW17
COM Requirement
Back Shell & Lower Side Panels = 2.75 yds.
Seat Cushion = 1 yd.

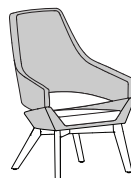

Code
Model
60223-H-U
60224-H-U
60227-H-U

TW18
COM Requirement
Inside Back Cushion & Seat Cushion = 1.75 yds.
Balance of Chair = 1.5 yds.

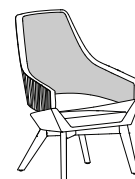

Code
Model
60223-H-W
60224-H-W
60227-H-W

TW19
COM Requirement
Inside Back Cushion = 1 yd.
Balance of Chair = 1.75 yds.

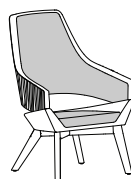

Code
Model
60223-H-W
60224-H-W
60227-H-W

TW20
COM Requirement
Inside Back Cushion & Seat Cushion = 1.75 yds.
Lower Side Panels = 1.5 yds.

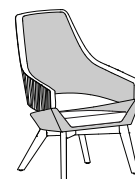

Code
Model
60223-H-W
60224-H-W
60227-H-W

TW21
COM Requirement
Inside Back Cushion & Lower Side Panels = 2.25 yds.
Seat Cushion = .75 yd.

All shipments for this series will be blanket-wrapped as standard. For customers located in Territory 1 who require cartoning, a 5% upcharge will be added to each product. Please contact client services for additional information.

VISOR LOUNGE | Designed by 5d Studio



SPECIFICATIONS:

- Lounge and love seat models available in Public and Private options.
- Sled base available in four standard finishes: 0405 Charcoal Grey, 0535 Metallic Silver, 0199 Chrome and 0630 Satin Black.
- Premium finishes also available.
- Swivel base lounge chair also offered.
- Swivel base is finished in stainless steel and features 360-degree turning radius with self-return.
- Lounge unit weight capacity: 350 lbs. Love seat weight capacity: 700 lbs.
- Optional contrasting welt offered on Private panels.
- Non-skid glides available for hard surface floors.
- All dimensions are nominal.
- Refer to terms and conditions for general information regarding fabrics, finishes, warranty, freight, complete condition of sales and more.

ROTATING TABLET:

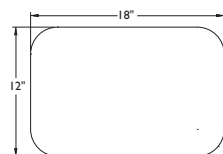

- Tablet is .75" thick, features 360-degree turning radius and is available on all Public seating units.
- Two surface options: laminate and solid surface.
- For standard wood grain laminate or solid black laminate tops, edge will match unless specified otherwise.
- For all other solid laminates, edge will be exposed plywood substrate with clear coat finish.
- For non-standard laminates, add \$649 List per color per order. Pre-approval required, please contact client services.
- Solid surface available in white only.
- Solid surface tops feature exposed plywood substrate edge with clear coat finish.
- Tablet mounting bracket will match corresponding seating unit base finish unless specified otherwise.
- 100 lb. weight capacity.

All shipments for this series will be blanket-wrapped as standard. For customers located in Territory 1 who require cartoning, a 5% upcharge will be added to each product. Please contact client services for additional information.

VISOR LOUNGE | Designed by 5d Studio

CUP HOLDER:

- Available on Private lounge units.
- Dimensions: 5" outer diameter, 3.5" inner diameter (cup size) x .25" deep.
- 0299 Polished Aluminum finish with black laminate inserts.

STANDARD METAL BASE FINISH COLORS:

- 0405 Charcoal Grey
- 0535 Metallic Silver
- 0199 Chrome (sled base only)
- 0399 Polished Stainless Steel (swivel base only)
- 0630 Satin Black

PREMIUM METAL BASE FINISH COLORS:



- 0605 Matte Black
- 0705 Matte Cotton
- 0788 Glossy Cotton
- 0805 Oasis
- 0905 Mint
- 1005 Mercury
- 1105 Canary
- 1205 Stone
- 1305 Sage
- 1405 Ice Blue
- 1505 Clay

All shipments for this series will be blanket-wrapped as standard. For customers located in Territory 1 who require cartoning, a 5% upcharge will be added to each product. Please contact client services for additional information.

VISOR LOUNGE | Designed by 5d Studio

ORDERING REQUIREMENTS:

- Model number
- Upholstery selection
- Options, as applicable

MODEL	PRODUCT SPECIFICATIONS	FABRIC GRADES										LEATHER	
		COM	A	1	2	3	4	COL 5	6	7	8	L1	L2
7725 	Public Lounge, Swivel Base 27.5" W x 28.5" D x 31.5" H Seat: 27.5" W x 19" D Seat Ht: 17.5" COM: 2 yds. COL: 40 sq. ft. 74 lbs.	1,673	1,801	1,871	1,913	1,979	2,051	2,115	2,183	2,249	2,317	2,633	2,861
7725-SP 	Semi-Private Lounge, Swivel Base 29.5" W x 30" D x 47.5" H Seat: 27.5" W x 19" D Seat Ht: 17.5" COM: 4.5 yds. COL: 90 sq. ft. 99 lbs.	2,501	2,789	2,947	3,041	3,190	3,352	3,496	3,649	3,797	3,950	4,661	5,174
7725-PR 	Private Lounge, Swivel Base 31.5" W x 30" D x 47.5" H Seat: 27.5" W x 19" D Seat Ht: 17.5" COM: 6 yds. COL: 120 sq. ft. 103 lbs.	2,561	2,945	3,155	3,281	3,479	3,695	3,887	4,091	4,289	4,493	5,441	6,125
XXXX-XX-CW	Privacy Panel Contrasting Welt COM: 1 yd. COL: n/a	179	243	278	299	332	368	400	434	467	501		

OPTIONS - PUBLIC AND SEMI-PRIVATE MODELS

-TAR03-L	Laminate Rotating Tablet, Right (as seated)	\$629
-TAL03-L	Laminate Rotating Tablet, Left (as seated)	\$629
-TAR03-SF	Solid Surface Rotating Tablet, Right (as seated)	\$692
-TAL03-SF	Solid Surface Rotating Tablet, Left (as seated)	\$692
-MB01	Moisture Barrier (seat only)	\$68

OPTIONS - PRIVATE MODELS



-CHR02	Cup Holder, Right (as seated)	\$205
-CHL02	Cup Holder, Left (as seated)	\$205
-MB01	Moisture Barrier (seat only)	\$68

All shipments for this series will be blanket-wrapped as standard. For customers located in Territory 1 who require cartoning, a 5% upcharge will be added to each product. Please contact client services for additional information.

VISOR LOUNGE | Designed by 5d Studio

ORDERING REQUIREMENTS:

- Model number
- Base finish
- Upholstery selection
- Options, as applicable

MODEL	PRODUCT SPECIFICATIONS	FABRIC GRADES										LEATHER	
		COM	A	1	2	3	4	COL 5	6	7	8	L1	L2
7701 	Public Lounge, Sled Base 27.5" W x 28.5" D x 31.5" H Seat: 27.5" W x 19" D Seat Ht: 17.5" COM: 2 yds. COL: 40 sq. ft. 30 lbs.	1,366	1,494	1,564	1,606	1,672	1,744	1,808	1,876	1,942	2,010	2,326	2,554
7701-SP 	Semi-Private Lounge, Sled Base 29.5" W x 30" D x 47.5" H Seat: 27.5" W x 19" D Seat Ht: 17.5" COM: 4.5 yds. COL: 90 sq. ft. 53 lbs.	2,192	2,480	2,638	2,732	2,881	3,043	3,187	3,340	3,488	3,641	4,352	4,865
7701-PR 	Private Lounge, Sled Base 31.5" W x 30" D x 47.5" H Seat: 27.5" W x 19" D Seat Ht: 17.5" COM: 6 yds. COL: 120 sq. ft. 58 lbs.	2,253	2,637	2,847	2,973	3,171	3,387	3,579	3,783	3,981	4,185	5,133	5,817
XXXX-XX-CW	Privacy Panel Contrasting Welt COM: 1 yd. COL: n/a	179	243	278	299	332	368	400	434	467	501		

OPTIONS - PUBLIC AND SEMI-PRIVATE MODELS

-PF02	Premium Metal Base Finish	\$101
-NS04	Non-Skid Glides	\$26
-MB01	Moisture Barrier (seat only)	\$68
-TAR03-L	Laminate Rotating Tablet, Right (as seated)	\$629
-TAL03-L	Laminate Rotating Tablet, Left (as seated)	\$629
-TAR03-SF	Solid Surface Rotating Tablet, Right (as seated)	\$692
-TAL03-SF	Solid Surface Rotating Tablet, Left (as seated)	\$692

OPTIONS - PRIVATE MODELS



-PF02	Premium Metal Base Finish	\$101
-CHR02	Cup Holder, Right (as seated)	\$205
-CHL02	Cup Holder, Left (as seated)	\$205
-NS04	Non-Skid Glides	\$26
-MB01	Moisture Barrier (seat only)	\$68

All shipments for this series will be blanket-wrapped as standard. For customers located in Territory 1 who require cartoning, a 5% upcharge will be added to each product. Please contact client services for additional information.

VISOR LOUNGE | Designed by 5d Studio

ORDERING REQUIREMENTS:

- Model number
- Base finish
- Upholstery selection
- Options, as applicable

MODEL	PRODUCT SPECIFICATIONS	FABRIC GRADES								LEATHER			
		COM	A	1	2	3	4	COL 5	6	7	8	L1	L2
7702 	Public Love Seat 45" W x 28.5" D x 31.5" H Seat: 45" W x 19" D Seat Ht: 17.5" COM: 2.75 yds. COL: 55 sq. ft. 44 lbs.	1,969	2,145	2,242	2,299	2,390	2,489	2,577	2,671	2,761	2,855	3,289	3,603
7702-SP 	Semi-Private Love Seat 47" W x 30" D x 47.5" H Seat: 45" W x 19" D Seat Ht: 17.5" COM: 5.75 yds. COL: 115 sq. ft. 68 lbs.	2,950	3,318	3,520	3,640	3,830	4,037	4,221	4,417	4,606	4,802	5,710	6,366
7702-PR 	Private Love Seat 49" W x 30" D x 47.5" H Seat: 45" W x 19" D Seat Ht: 17.5" COM: 6.5 yds. COL: 130 sq. ft. 80 lbs.	3,011	3,427	3,655	3,791	4,006	4,240	4,448	4,669	4,883	5,104	6,131	6,872
XXXX-XX-CW	Privacy Panel Contrasting Welt COM: 1 yd. COL: n/a	244	308	343	364	397	433	465	499	532	566		

OPTIONS - PUBLIC AND SEMI-PRIVATE MODELS

-PF02	Premium Metal Base Finish	\$101
-NS04	Non-Skid Glides	\$26
-MB02	Moisture Barrier (seat only)	\$89
-TAR03-L	Laminate Rotating Tablet, Right (as seated)	\$629
-TAL03-L	Laminate Rotating Tablet, Left (as seated)	\$629
-TAR03-SF	Solid Surface Rotating Tablet, Right (as seated)	\$692
-TAL03-SF	Solid Surface Rotating Tablet, Left (as seated)	\$692

OPTIONS - PRIVATE MODELS

-PF02	Premium Metal Base Finish	\$101
-CHR02	Cup Holder, Right (as seated)	\$205
-CHL02	Cup Holder, Left (as seated)	\$205
-NS04	Non-Skid Glides	\$26
-MB02	Moisture Barrier (seat only)	\$89

VISOR LOUNGE | Designed by 5d Studio

UPHOLSTERY COMBINATIONS:

- For upholstery combinations, refer to the pricing below.
- When combining two COM/COV/COL fabrics, or fabrics with the same grade, add \$120 List per unit.
- When combining three or more COM/COV/COL fabrics, or fabrics with the same grade, add \$150 List per unit.
- When combining different grades of fabric, price will be based on the highest grade specified.
- Two-tone upholstery examples and yardage requirements for the most common combinations are listed below. Additional combinations available; please contact client services for yardage requirements and pricing.
- Note: Yardage amounts are based on fabric which is plain (i.e. non-directional) and a full 54" wide.
- Appropriate upholstery code must be included.



Code VS1
Model COM Requirement
 7725 Seat = 1 yd.
 Back = 1.5 yds.

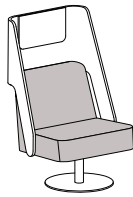

Code VS2
Model COM Requirement
 7725-SP Seat & Back = 2.5 yds.
 Privacy Panel = 2.5 yds.



Code VS3
Model COM Requirement
 7725-PR Seat & Back = 2.5 yds.
 Privacy Panel = 4 yds.

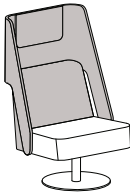

Code VS4
Model COM Requirement
 7725-SP Seat = 1 yd.
 Privacy Panel & Back = 4 yds.

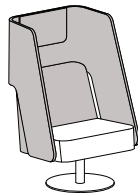

Code VS5
Model COM Requirement
 7725-PR Seat = 1 yd.
 Privacy Panel & Back = 5.5 yds.

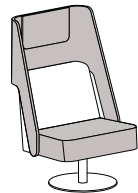

Code VS6
Model COM Requirement
 7725-SP Seat & Privacy Panel = 3.5 yds.
 Back = 1.5 yds.

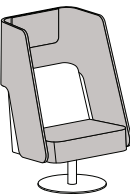

Code VS7
Model COM Requirement
 7725-PR Seat & Privacy Panel = 5 yds.
 Back = 1.5 yds.



Code VS8
Model COM Requirement
 7701 Seat = 1 yds.
 7701-M Back = 1.5 yds.

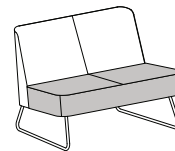

Code VS9
Model COM Requirement
 7702 Seat = 1.5 yds.
 7702-M Back = 1.5 yds.

VISOR LOUNGE | Designed by 5d Studio

UPHOLSTERY COMBINATIONS:

- For upholstery combinations, refer to the pricing below.
- When combining two COM/COV/COL fabrics, or fabrics with the same grade, add \$120 List per unit.
- When combining three or more COM/COV/COL fabrics, or fabrics with the same grade, add \$150 List per unit.
- When combining different grades of fabric, price will be based on the highest grade specified.
- Two-tone upholstery examples and yardage requirements for the most common combinations are listed below. Additional combinations available; please contact client services for yardage requirements and pricing.
- Note: Yardage amounts are based on fabric which is plain (i.e. non-directional) and a full 54" wide.
- Appropriate upholstery code must be included.

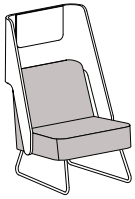

Code VS10
Model COM Requirement
 7701-SP Seat & Back = 2.5 yds.
 Privacy Panel = 2.5 yds.

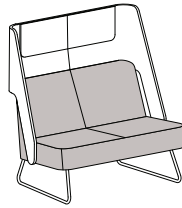

Code VS11
Model COM Requirement
 7702-SP Seat & Back = 3 yds.
 Privacy Panel = 3 yds.

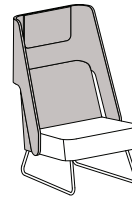

Code VS12
Model COM Requirement
 7701-SP Seat = 1 yd.
 Privacy Panel & Back = 4 yds.

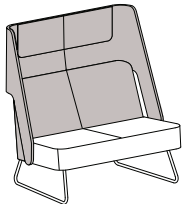

Code VS13
Model COM Requirement
 7702-SP Seat = 1.5 yds.
 Privacy Panel & Back = 5 yds.

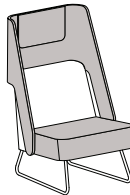

Code VS14
Model COM Requirement
 7701-SP Seat & Privacy Panel = 3.5 yds.
 Back = 1.5 yds.

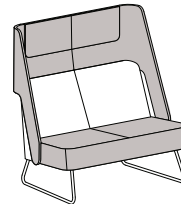

Code VS15
Model COM Requirement
 7702-SP Seat & Privacy Panel = 4.5 yds.
 Back = 1.5 yds.

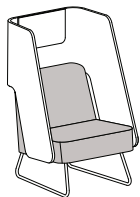

Code VS16
Model COM Requirement
 7701-PR Seat & Back = 2.5 yds.
 Privacy Panel = 4 yds.

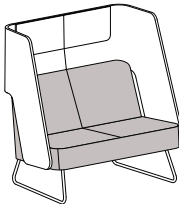

Code VS17
Model COM Requirement
 7702-PR Seat & Back = 3 yds.
 Privacy Panel = 4 yds.

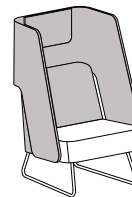

Code VS18
Model COM Requirement
 7701-PR Seat = 1 yd.
 Privacy Panel & Back = 5.5 yds.

VISOR LOUNGE | Designed by 5d Studio

UPHOLSTERY COMBINATIONS:

- For upholstery combinations, refer to the pricing below.
- When combining two COM/COV/COL fabrics, or fabrics with the same grade, add \$120 List per unit.
- When combining three or more COM/COV/COL fabrics, or fabrics with the same grade, add \$150 List per unit.
- When combining different grades of fabric, price will be based on the highest grade specified.
- Two-tone upholstery examples and yardage requirements for the most common combinations are listed below. Additional combinations available; please contact client services for yardage requirements and pricing.
- Note: Yardage amounts are based on fabric which is plain (i.e. non-directional) and a full 54" wide.
- Appropriate upholstery code must be included.

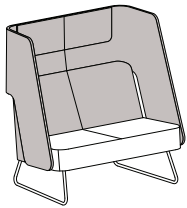

Code VS19
Model 7702-PR
COM Requirement Seat = 1.5 yds.
Privacy Panel & Back = 5.5 yds.

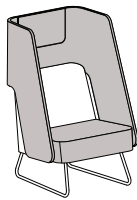

Code VS20
Model 7701-PR
COM Requirement Seat & Privacy Panel = 5 yds.
Back = 1.5 yds.

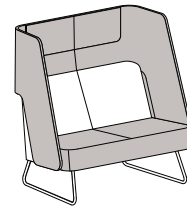

Code VS21
Model 7702-PR
COM Requirement Seat & Privacy Panel = 5.5 yds.
Back = 1.5 yds.

All shipments for this series will be blanket-wrapped as standard. For customers located in Territory 1 who require cartoning, a 5% upcharge will be added to each product. Please contact client services for additional information.

WAKE STOOLS | Designed by Chris Panichella



SPECIFICATIONS:

- Three seated heights: 18", 25" and 30".
- Fully upholstered and sculpted plywood seat models available.
- Three wood species available: Beech, White Oak and Walnut.
- Available in all standard wood finishes.
- For Super Matte Sable finish on Beech or White Oak, upcharge applies. Refer to option section for pricing.
- ½" diameter steel rod frame.
- Frame available in standard and premium finishes. Please refer to listing below.
- All models stack up to 5 high.
- 350 lb. weight capacity.
- Optional clear glides for hard surface flooring.
- All dimensions are nominal.
- Refer to terms and conditions for general information regarding fabrics, finishes, warranty, freight, complete condition of sales and more.

STANDARD METAL FRAME FINISH COLORS:

- 0405 Charcoal Grey
- 0535 Metallic Silver
- 0199 Chrome
- 0630 Satin Black

PREMIUM METAL FRAME FINISH COLORS:





- 0605 Matte Black
- 0705 Matte Cotton
- 0788 Glossy Cotton
- 0805 Oasis
- 0905 Mint
- 1005 Mercury
- 1105 Canary
- 1205 Stone
- 1305 Sage
- 1405 Ice Blue
- 1505 Clay

All shipments for this series will be blanket-wrapped as standard. For customers located in Territory 1 who require cartoning, a 5% upcharge will be added to each product. Please contact client services for additional information.

WAKE STOOLS | Designed by Chris Panichella

ORDERING REQUIREMENTS:

- Model number
- Wood finish
- Frame finish
- Options, as applicable

MODEL	PRODUCT SPECIFICATIONS	LIST
1110-18 	18" Height Stool, Wood Seat 21.25" W x 19" D x 19.5" H Seat: 16.75" W x 16.25" D Seat Ht: 18" 13 lbs.	724
1110-25 	25" Height Stool, Wood Seat 21.25" W x 20" D x 25.5" H Seat: 16.75" W x 16.25" D Seat Ht: 25" 18 lbs.	806
1110-30 	 30" Height Stool, Wood Seat 21.25" W x 20" D x 31.25" H Seat: 16.75" W x 16.25" D Seat Ht: 30" 20 lbs.	813

OPTIONS

-PF02	Premium Metal Frame Finish	\$101
-SM02	Super Matte Sable Wood Finish	\$23
-CG02	Clear Glides (Set of 4)	\$12





 = Available on quick-ship program (0535 Metallic Silver and 0199 Chrome frame with standard wood finishes only).

All shipments for this series will be blanket-wrapped as standard. For customers located in Territory 1 who require cartoning, a 5% upcharge will be added to each product. Please contact client services for additional information.

WAKE STOOLS | Designed by Chris Panichella

ORDERING REQUIREMENTS:

- Model number
- Wood finish
- Frame finish
- Upholstery selection
- Options, as applicable

MODEL	PRODUCT SPECIFICATIONS	FABRIC GRADES										LEATHER	
		COM	A	1	2	3	4	COL 5	6	7	8	L1	L2
1120-18	 <p>18" Height Stool, Wood Seat with Upholstered Cushion 21.25" W x 19" D x 19.5" H Seat: 16.75" W x 16.25" D Seat Ht: 18.5" COM: .75 yd. COL: 15 sq. ft. 14 lbs.</p>	801	849	876	891	916	943	967	993	1,017	1,043	1,161	1,247
1120-25	 <p>25" Counter-Height Stool, Wood Seat with Upholstered Cushion 21.25" W x 20" D x 25.5" H Seat: 16.75" W x 16.25" D Seat Ht: 25" COM: .75 yd. COL: 15 sq. ft. 19 lbs.</p>	905	953	980	995	1,020	1,047	1,071	1,097	1,121	1,147	1,265	1,351
1120-30	 <p> 30" Bar-Height Stool, Wood Seat with Upholstered Cushion 21.25" W x 20" D x 31.25" H Seat: 16.75" W x 16.25" D Seat Ht: 30.5" COM: .75 yd. COL: 15 sq. ft. 21 lbs.</p>	910	958	985	1,000	1,025	1,052	1,076	1,102	1,126	1,152	1,270	1,356

OPTIONS

-PF02	Premium Metal Frame Finish	\$101
-SM02	Super Matte Sable Wood Finish	\$23
-CG02	Clear Glides (Set of 4)	\$12

 = Available on quick-ship program (0535 Metallic Silver and 0199 Chrome frame with standard wood finishes only).

All shipments for this series will be blanket-wrapped as standard. For customers located in Territory 1 who require cartoning, a 5% upcharge will be added to each product. Please contact client services for additional information.

WAKE STOOLS | Designed by Chris Panichella

ORDERING REQUIREMENTS:

- Model number
- Frame finish
- Upholstery selection
- Options, as applicable

MODEL	PRODUCT SPECIFICATIONS	FABRIC GRADES										LEATHER	
		COM	A	1	2	3	4	COL 5	6	7	8	L1	L2
1130-18	18" Height Stool, Fully Upholstered Seat 21.25" W x 19" D x 19.5" H Seat: 16.75" W x 16.25" D Seat Ht: 18.5" COM: .75 yd. COL: 15 sq. ft. 14 lbs.	789	837	864	879	904	931	955	981	1,005	1,031	1,149	1,235
1130-25	25" Counter-Height Stool, Fully Upholstered Seat 21.25" W x 20" D x 25.5" H Seat: 16.75" W x 16.25" D Seat Ht: 25" COM: .75 yd. COL: 15 sq. ft. 19 lbs.	871	919	946	961	986	1,013	1,037	1,063	1,087	1,113	1,231	1,317
1130-30	 30" Bar-Height Stool, Fully Upholstered Seat 21.25" W x 20" D x 31.25" H Seat: 16.75" W x 16.25" D Seat Ht: 30.5" COM: .75 yd. COL: 15 sq. ft. 21 lbs.	878	926	953	968	993	1,020	1,044	1,070	1,094	1,120	1,238	1,324

OPTIONS

- PF02 Premium Metal Frame Finish \$101
- CG02 Clear Glides (Set of 4) \$12

 = Available on quick-ship program (0535 Metallic Silver and 0199 Chrome frame finishes only).